

**BH-B521**



**Replaces**

**BOSCH :**

1-194-336-035

**CHRYSLER :**

5123991

**Unit no.**

BOSCH

0-120-400-944

**BH-ND01**



**Replaces**

DENSO :  
021620-2180      021620-2630

**BH-ND03**



**Replaces**

DENSO :  
021620-2430

**BH-ND06**



**Unit no.**

DENSO  
104210-3512  
FORD  
3M5T-10300PC

**BH-ND08**



Unit no.

DENSO  
104210-8310  
HYUNDAI  
37300-3C170  
TOYOTA  
27060-40060

**BH-ND10**



Replaces

DENSO :  
021620-2720  
TOYOTA :  
27370-42010

Unit no.

DENSO  
100211-6030      100211-6031      100211-6050      100211-6051

**BH-ND11**



Replaces

DENSO :  
021620-3001

Unit no.

DENSO  
421000-0030      421000-0021      421000-0022      421000-0023      421000-0024      421000-0025  
421000-0026      421000-0027      421000-0028

**BH-ND12**



Unit no.

DENSO

104210-205	104210-208	104210-209	104210-289	104210-420	104210-422
104210-423	104210-442	104210-447	104210-454	104210-470	104210-492
104210-551	104210-563	104210-616	421000-022	421000-023	421000-038
104210-6101					

FORD

7C3T-10300EE



**BH-H01**



**Replaces**

HITACHI :  
L170G-2330

**Unit no.**

HITACHI

LR170-501C	LR170-502B	LR170-502C	LR170-503	LR170-504	LR170-504B
LR170-504C	LR170-505E	LR170-511	LR170-511B	LR170-512B	LR170-512C

**BH-H02**



**Unit no.**

HITACHI

LR1100-704B	LR1100-709	LR160-727	LR170-745	LR170-748	LR170-748B
LR180-741H	LR180-744	LR180-751	LR190-729		

BH-M01



Unit no.

CHRYSLER

4661998

4671041

4686106

4793189

4793190

MITSUBISHI

A2T81192

A2T81292

A2T81391

## TB-B001

\*Terminal Block

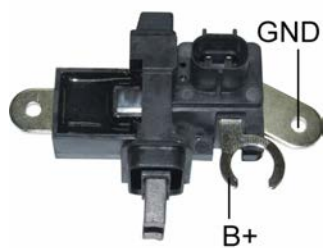

### Replaces

#### BOSCH :

6-004-MR0-000    F-00M-145-250    F-00M-145-426    F-00M-145-477

#### Unit no.

#### BOSCH

0-124-425-001	0-124-515-084	0-124-515-115	0-124-525-002	0-124-525-003	0-124-525-004
0-124-525-005	0-124-525-007	0-124-615-018	0-124-615-032	6-004-MA5-001	6-004-ML0-001
6-004-ML0-002	6-004-ML0-004	6-004-ML0-005			

#### CHRYSLER

56028237	56028237AB	56028238	56028238AB	56028239	56028239AB
56028241	56028560AA	56041120AC	56041322	56041322AB	

## VR-B020

\*B-Circuit  
 \*LIN-1  
 \*19200 Baud Rate  
 \*Requires COM01 test adaptor for testing



### Replaces

#### BOSCH :

F-00M-346-020    F-00M-346-036    F-00M-346-048    F-00M-346-081

#### Unit no.

#### BOSCH

0-120-000-025	0-121-813-001	0-121-813-002	0-121-813-003	0-121-813-005	0-121-813-006
0-121-813-014	0-121-813-020				

## VR-B021



- \*B-Circuit
- \*Voltage Set Point: 14.2V
- \*LIN-1
- \*19200 Baud Rate (4 Byte)
- \*Requires COM01 test adaptor for testing

### Replaces

#### BOSCH :

F-00M-346-008    F-00M-346-021    F-00M-346-037    F-00M-346-080    F-00M-346-047

### Unit no.

#### BOSCH

0-121-715-006    0-121-715-007    0-121-715-014    0-121-715-015    0-121-715-029

#### MERCEDES

0131543502    0131545602    0131547002    0131549002    1561540102    2721540802

A0131547002    A0131549002    A131547002

### Used On

#### MERCEDES-BENZ

E350 V6 3.5L	2006-
S550 V8 5.5L	2007-
GL450 V8 4.6L	2007-
ML350 V6 3.5L	2007-

## VR-B026



- \*B-Circuit
- \*Soft Start
- \*8.5 sec. LRC
- \*Short Circuit Protection
- \*Voltage Set Point: 14.5V
- \*FR is in phase with F

### Replaces

#### BOSCH :

F-00M-346-010    F-00M-346-015    F-00M-346-026    F-00M-346-087

### Unit no.

#### BOSCH

0-121-615-001    0-121-615-002    0-121-615-003

#### FORD

6C1T-10300AA    6C1T-10300AB    6C1T-10300AC

**VR-B029**



**Replaces**

**BOSCH :**

F-00M-346-029    F-00M-346-053    F-00M-346-136

**Unit no.**

**BOSCH**

0-121-615-013    0-121-615-029    0-121-715-004

**VR-B033**



- \*B-Circuit
- \*BSS Connections
- \*Requires COM01 test adaptor for testing

**Replaces**

**BMW :**

12317551254    12317551256    12317561924    12317561939

**BOSCH :**

F-00M-346-013    F-00M-346-024    F-00M-346-033    F-00M-346-089

**Unit no.**

**BMW**

12317542351    12317550469    12317551254    12317551256    12317551256    12317555926

12317557789    12317558219    12317558220    12317560985    12317560986    12317582699

**BOSCH**

0-121-715-012    0-121-715-016    0-121-715-017    0-121-715-018    0-121-715-112    0-121-715-116

0-121-715-118

**Used On**

**BMW**

128i 3.0L	2008-2010
323i 2.5L	2007-2009
328i 3.0L	2007-2010
330Ci 3.0L	2007-2008
528i 3.0L	2008-2010
X3 3.0L	2007-2010
X5 3.0L	2007-2008

## VR-B056



- \*B-Circuit
- \*Voltage Set Point: 13.8V
- \* LIN-1
- \* 9600 Baud Rate (4 Byte)
- \*Requires COM01 test adaptor for testing

### Replaces

#### BOSCH :

F-00M-346-005    F-00M-346-019    F-00M-346-056    F-00M-346-122    F-00M-346-131    F-00M-346-166

#### FORD :

CN15-10316AA

#### VOLVO :

300667453                    300667454

### Unit no.

#### BOSCH

0-120-000-003	0-120-000-029	0-121-615-005	0-121-615-006	0-121-615-007	0-121-615-008
0-121-615-009	0-121-615-014	0-121-615-021	0-121-615-028	0-121-715-002	0-121-715-008
0-121-715-024	0-121-715-032	F-000-BL0-639	F-000-BL0-6AK	F-000-BL0-6B7	F-000-BL0-6Z0

### Used On

#### FORD

Mondeo 2.2L DSL	2008-
Galaxy 2.0L TDCi	2006-

#### VOLVO

XC90 4.4L	2005-2008
S80 4.4L	2006-2007

## VR-B057



- \* B-Circuit
- \* Voltage Set Point: 13.8V
- \* LIN-1
- \* 9600 Baud Rate (4 Byte)
- \* Requires COM01 test adaptor for testing

### Replaces

#### BOSCH :

F-00M-346-074    F-00M-346-165    F-00M-346-023    F-00M-346-057    F-00M-346-098

### Unit no.

#### BOSCH

0-125-711-005	0-121-615-011	0-121-715-009	0-125-711-106
---------------	---------------	---------------	---------------

#### FORD

BG9T-10300AB

**VR-B066**

\*BSS Connections

PICTURE  
IS NOT  
AVAILABLE

**Replaces****BOSCH :**

F-00M-346-066

**Unit no.**

BOSCH

0-121-615-027    0-121-615-012    0-121-615-127    0-121-651-044

**VR-B0701**

PICTURE  
IS NOT  
AVAILABLE

**Replaces****BOSCH :**

0-272-220-701

**Unit no.**

BOSCH

F-000-BL0-730    F-000-BL0-424    F-000-BL0-618

**Used On****VOLKSWAGEN**

Polo 1.4 Non-turbo Gas

2011-

Polo 1.4 Turbo, Gas

2012-

Polo 1.6 Non-turbo Gas

2099-2013

**VR-B088**

PICTURE  
IS NOT  
AVAILABLE

**Replaces****BOSCH :**

F-00M-346-032    F-00M-346-025    F-00M-346-014    F-00M-346-088

**Unit no.**

BMW

12317550967

12317551254

BOSCH

0-121-615-010

**VR-B092**



- \*B-Circuit
- \*Voltage Set Point: 14.2V
- \* LIN-1
- \* 19200 Baud Rate (4 Byte)
- \* Requires COM01 test adaptor for testing

**Replaces**

**BOSCH :**

F-00M-346-092    F-00M-346-139

**Unit no.**

BOSCH

0-121-715-078	0-121-715-049	0-121-715-050	0-121-715-051	0-121-715-071	0-121-715-076
0-121-715-077	0-121-715-080	0-121-715-171	0-121-715-176		

**VR-B100**

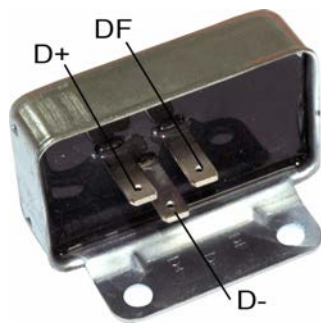

- \*B-Circuit
- \*24V
- \*Inactive Lamp
- \*Voltage Set Point:28.0V

**Replaces**

**BOSCH :**

9-190-085-000

**Unit no.**

BOSCH

9-120-080-039	9-120-080-049	9-120-080-055	9-120-080-058	9-120-080-064	9-120-080-067
9-120-080-069	9-120-080-073	9-120-080-075	9-120-080-085	9-120-080-094	9-120-080-103
9-120-080-104	9-120-080-105	9-120-080-106	9-120-080-113	9-120-080-146	9-120-080-150

**VR-B101**

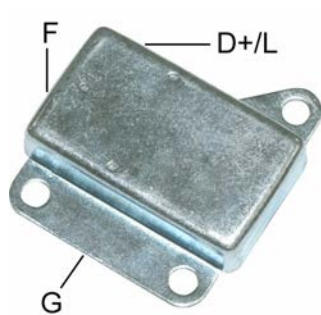

- \*A-Circuit
- \*Inactive Lamp
- \*Voltage Set Point: 14.0V

**Replaces**

**BOSCH :**

9-190-087-003

**Unit no.**

BOSCH

9-120-080-041	9-120-080-061	9-120-080-072	9-120-080-090	9-120-080-122	F-000-LD0-108
---------------	---------------	---------------	---------------	---------------	---------------



## VR-B102

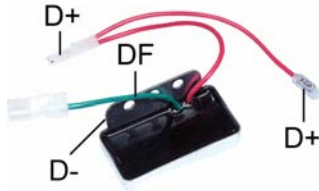

\*B-Circuit  
 \*Inactive Lamp  
 \*Voltage Set Point:14.2V

### Replaces

**BOSCH :**  
 9-190-457-007  
**VOLKSWAGEN :**  
 0409038032

### Unit no.

BOSCH  
 9-120-450-998

## VR-B103



\*A-Circuit  
 \*Voltage Set Point: 14.0V

### Replaces

**BOSCH :**  
 9-190-087-026      9-190-087-032

### Unit no.

BOSCH

0-120-484-011	0-120-484-205	9-120-080-153	9-120-080-165	9-120-080-168	9-120-080-169
9-120-080-170	9-120-080-171	9-120-080-172	9-120-080-173	9-120-080-180	9-120-080-198
9-120-080-203	9-120-080-208	9-120-080-211	9-120-080-213		

## VR-B104



\*A-Circuit  
 \*Voltage Set Point: 14.2V

### Replaces

**BOSCH :**  
 9-190-087-028

### Unit no.

BOSCH

9-120-080-161	9-120-080-163	9-120-080-164	9-120-080-167	9-120-080-175	9-120-080-176
9-120-080-177	9-120-080-178	9-120-080-179	9-120-080-185	9-120-080-186	9-120-080-190
9-120-080-191	9-120-080-192	9-120-080-193	9-120-080-194		

**VR-B118B**

\*24V

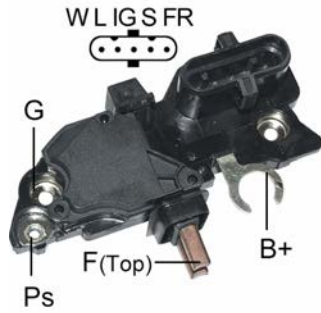

**Replaces**

**BOSCH :**

F-00M-144-118    F-00M-145-299    F-00M-145-267    F-00M-144-102

**Unit no.**

**BOSCH**

0-124-555-003    0-124-555-036    0-124-555-038    0-124-555-040    0-124-555-041    0-124-555-052  
 0-124-655-003    0-124-655-036    0-124-655-037    0-124-655-039

**VR-B121B**

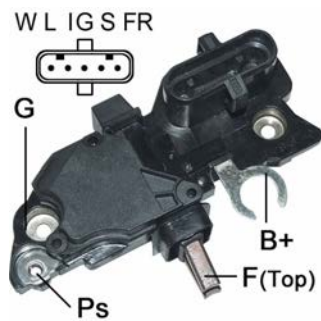

**VR-B122B**

- \*24V
- \*B-Circuit
- \*Soft Start
- \*Short Circuit Protection
- \*Voltage Set Point: 25.6V

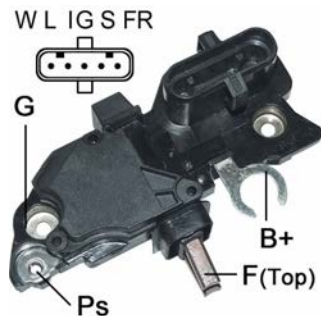

**Replaces**

**BOSCH :**

F-00M-145-300    F-00M-144-122    F-00M-145-294    F-00M-144-106

**Unit no.**

**BOSCH**

0-124-555-013    0-124-555-014    0-124-555-034    0-124-655-009    0-124-655-011    0-124-655-025  
 0-124-655-026    0-124-655-047

**MAN**

51256010006

**SCANIA**

1797688

**Used On**

**MAN**

TGA Series D0836	2002-2013
TGA Series D2066	2004-2013
TGL Series	2005-2013
TGM Series	2005-2013
TGS Series	2007-2013
TGX Series	2007-2013

**VR-B129**

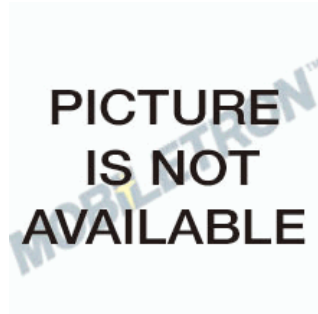

**Replaces**

**BOSCH :**

F-00M-144-129

**Unit no.**

BOSCH

0-124-615-029    F-00M-145-313    F-00M-145-386

**VR-B131**

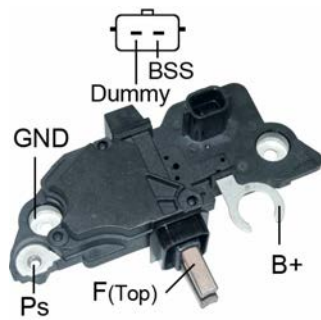

- \*B-Circuit
- \*BSS Connections
- \*Requires COM01 test adaptor for testing

**Replaces**

**BOSCH :**

F-00M-144-131    F-00M-145-304    F-00M-145-321

**Unit no.**

BOSCH

0-124-425-011	0-124-425-013	0-124-425-018	0-124-425-029	0-124-425-034	0-124-425-037
0-124-425-038	0-124-425-039	0-124-425-042	0-124-425-045	0-124-425-046	0-124-425-047
0-124-425-069	0-124-425-070	0-124-425-071	0-124-425-074	0-124-425-075	

RENAULT

8000429905	8200323137	82 0323137	8200660025	8200325823	8200356669
8200360480	8200429905	8200518409	8200660033	8200660034	8200660043
8200726639					

**Used On**

**RENAULT**

Clio 1400 16V	2005-2010
Clio 1600 16V	2005-2010
Modus 1400 16V	2005-2010
Modus 1600 16V	2005-2010

## VR-B132



\*A-Circuit  
 \*COM  
 \*Requires COM01 test adaptor for testing

### Replaces

#### BOSCH :

F-00M-145-156    F-00M-144-108    F-00M-144-132    F-00M-145-292    F-00M-145-374    F-00M-145-884

#### MERCEDES-BENZ :

0031544106    A0031545906    A0031547106    A0041540306    0031545906    0031547106  
 0041540306    A0031544106

### Unit no.

BOSCH

0-124-625-014    0-124-625-015    0-124-625-045    11216

MERCEDES-BENZ

0121549902    0131540002

## VR-B135

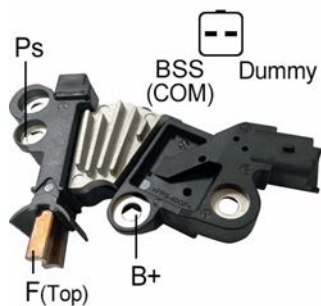

\*B-Circuit  
 \*BSS Connections  
 \*Requires COM01 test adaptor for testing

### Replaces

#### BOSCH :

F-00M-346-135

### Unit no.

BMW

12317604782    12317613445

BOSCH

0-125-711-011

### Used On

#### MINI

Cooper 1.6L	2011-2013
Cooper Countryman 1.6L	2011-2013
Cooper Paceman 1.6L	2013-

**VR-B137**



- \*B-Circuit
- \* Soft Start
- \* 8.5 sec. LRC
- \* Short Circuit Protection
- \* Voltage Set Point: 14.5V
- \* FR phase and F phase reverse

**Replaces**

**BOSCH :**  
F-00M-346-137

**Unit no.**

BOSCH  
0-121-715-003

**VR-B150**

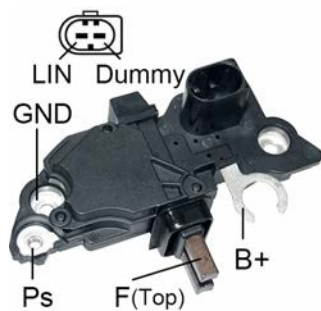

- \*B-Circuit
- \*Voltage Set Point: 14.2V
- \*LIN-1
- \*19200 Baud Rate (4 Byte)
- \*Requires COM01 test adaptor for testing

**Replaces**

<b>BOSCH :</b>					
F-00M-145-323	F-00M-145-380	F-00M-154-323	F-00M-145-665	F-00M-145-698	
<b>MERCEDES-BENZ :</b>					
003-154-72-06	003-154-96-06	31547206	31549606	003 154 72 06	003 154 96 06
A 003 154 72 06	A 003 154 96 06				

**Used On**

<b>MERCEDES-BENZ</b>	
Sprinter 209	2006-2010
Sprinter 211	2006-2010
Sprinter 311	2006-2010

**VR-B160**



- \*B-Circuit
- \*Soft Start
- \*8.5 sec. LRC
- \*Short Circuit Protection
- \*Voltage Set Point: 14.5V

**Replaces**

**BOSCH :**  
F00M144109      F00M144160

**Unit no.**

<b>BOSCH</b>					
0-124-325-163	0-124-325-171	0-124-325-172	0-124-325-221	0-124-425-050	0-124-425-057
0-124-425-058	0-124-425-059	0-124-425-060	0-124-425-084	0-124-425-085	0-124-425-086
0-124-425-087	0-124-425-096	0-124-425-097			

## VR-B190

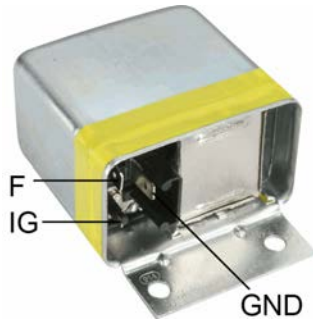

\*Mechanic Type  
\*Voltage Set Point:14.8V

### Replaces

#### ALFA ROMEO :

530165

#### AUDI/VW :

021903803A    043903803B    059903803A    21903803    28903803    411903803A  
59903803

#### BMW :

01244409    1350052    1355456    8708000

#### BOSCH :

0-190-600-001	0-190-600-002	0-190-600-003	0-190-600-004	0-190-600-005	0-190-600-006
0-190-600-007	0-190-600-008	0-190-600-009	0-190-600-010	0-190-600-011	0-190-600-012
0-190-600-013	0-190-600-014	0-190-600-015	0-190-600-016	0-190-600-017	0-190-600-018
0-190-600-020	0-190-600-021	0-190-601-001	0-190-601-002	0-190-601-003	0-190-601-006
0-190-601-007	0-190-601-008	0-190-601-009	0-190-601-010	0-190-601-011	0-190-601-012
0-190-601-013	0-190-601-017	0-190-601-018	0-192-062-001	0-192-062-002	0-192-062-004
0-192-062-005	0-192-062-007	9-190-085-001	9-190-087-011		

#### FAUN :

1713068

#### FIAT :

4224467

#### FORD :

11436766    11444238    11444273

#### IHC :

3136411R92    3144046R1

#### ISKRA :

11-125-009    11-125-015    11-125-106    AER2901    AER2902    AER3003

#### JOHN DEERE :

AT31413

#### KLOCKNER-HUMBOL-DEUTZ :

1160363EF8976    1160363EF8976-1    T1H7615    T4H7615

#### LAMBORGHINI :

29429600

#### LIEBHERR :

6930211

#### LUCAS :

21931004    21931013    37697    NCB205    NCB403

#### MAGIRUS-DEUTZ :

1160363    1160376

#### MAGNETI MARELLI :

63400006    64800001

#### MAN :

51256017037    81256010002    81256010003    81256010004    81256010005    81256010021  
90801101270

#### MASSEY FERGUSON :

1718347M1

#### MERCEDES-BENZ :

11545106    11546806    11546906    11548406    11548506    1548506  
21541506    21542806    21543006    21543606    21547406

#### OPEL :

1204226    1204229    1204230    1204231    1204235    1204239  
1204254    1204439

#### PORSCHE :

90160320301    90160320600    90160320601    90160320602

#### RENAULT :

5000255685    5000273021    5001001392    7701014809

#### SAAB :

7334634

#### SCANIA :

**VR-B190**

229511 263903

**SEAT :**

HB90600000

**SEV MARCHAL :**

72160602	72160702	72160902	72210002	72317102	72710502
72711102	72717002	72717202	72717302	72717402	

**STEYR :**

609F090019 614090017

**VALEO :**

505043 78700 97163 NC328

**VALEO(DUCELLIER) :**

510003 519002 8375

**VALEO(MOTOROLA) :**

9RH7005

**VALEO(PARIS RHONE) :**

AYC2112 YL414

**VOLVO :**

01214719	1234519	1308030	241534	241808	241960
246585	248279	530878	531914	588950	6212039

**Unit no.**

BOSCH

0-120-400-522	0-120-400-537	0-120-400-607	0-120-400-620	0-120-400-630	0-120-400-654
0-120-400-716	0-120-400-722	0-120-400-726	0-120-400-728	0-120-400-758	0-120-400-764
0-120-400-767	0-120-400-771	0-120-400-803	0-120-400-808	0-120-400-815	0-120-400-840
0-120-400-852	0-120-400-858	0-120-400-869	0-120-400-912	0-120-450-001	

FORD

E8GY-10346-A E8GY-10346-B E9BZ-10346-A

HYUNDAI

37300-21013 37300-21320 37900-21030

MANDO

AR160A

## VR-B191

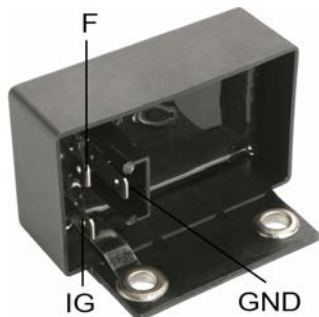

\*Electronic Type  
\*Voltage Set Point:14.5V

### Replaces

#### ALFA ROMEO :

530165

#### AUDI/VW :

021903803A	043903803B	059903803A	21903803	28903803	411903803A
------------	------------	------------	----------	----------	------------

59903803

#### BMW :

01244409	1350052	1355456	8708000
----------	---------	---------	---------

#### BOSCH :

0190062001	0190062002	0190062004	0190062005	0190062007	0190601011
9190085001	9190087011	136325	0190600001	0190600002	0190600003
0190600004	0190600005	0190600006	0190600007	0190600008	0190600009
0190600010	0190600011	0190600012	0190600013	0190600014	0190600015
0190600016	0190600017	0190600018	0190600020	0190600021	0190601001
0190601002	0190601003	0190601006	0190601007	0190601008	0190601009
0190601010	0190601011	0190601012	0190601013	0190601017	0190601018
0192062001	0192062002	0192062004	0192062005	0192062007	9190085001

#### FAUN :

1713068

#### FIAT :

4224467

#### FORD :

11436766	11444238	11444273
----------	----------	----------

#### IHC :

3136411R92	3144046R1
------------	-----------

#### ISKRA :

11-125-009	11-125-015	11-125-106	AER2901	AER2902	AER3003
------------	------------	------------	---------	---------	---------

#### JOHN DEERE :

AT31413

#### KLOCKNER-HUMBOL-DEUTZ :

1160363EF8976	1160363EF8976-1	T1H7615	T4H7615
---------------	-----------------	---------	---------

#### LAMBORGHINI :

29429600

#### LIEBHERR :

6930211

#### LUCAS :

21931004	21931013	37697	NCB205	NCB403
----------	----------	-------	--------	--------

#### MAGIRUS-DEUTZ :

1160363	1160376
---------	---------

#### MAGNETI MARELLI :

63400006	64800001
----------	----------

#### MAN :

51256017037	81256010002	81256010003	81256010004	81256010005	81256010021
-------------	-------------	-------------	-------------	-------------	-------------

90801101270

#### MASSEY FERGUSON :

1718347M1

#### MERCEDES-BENZ :

11545106	11546806	11546906	11548406	11548506	1548506
21541506	21542806	21543006	21543606	21547406	

#### OPEL :

1204226	1204229	1204230	1204231	1204235	1204239
1204254	1204439				

#### PORSCHE :

90160320301	90160320600	90160320601	90160320602
-------------	-------------	-------------	-------------

#### RENAULT :

5000255685	5000273021	5001001392	7701014809
------------	------------	------------	------------

#### SAAB :

7334634



**VR-B191**

**SCANIA :**

229511 263903

**SEAT :**

HB90600000

**SEV MARCHAL :**

72160602	72160702	72160902	72210002	72317102	72710502
72711102	72717002	72717202	72717302	72717402	

**STEYR :**

609F090019 614090017

**VALEO :**

505043 78700 97163 NC328

**VALEO(DUCELLIER) :**

510003 519002 8375

**VALEO(MOTOROLA) :**

9RH7005

**VALEO(PARIS RHONE) :**

AYC2112 YL414

**VOLVO :**

01214719	1234519	1308030	241534	241808	241960
246585	248279	530878	531914	588950	6212039

Unit no.

BOSCH

0-120-400-522	0-120-400-537	0-120-400-607	0-120-400-620	0-120-400-630	0-120-400-654
0-120-400-716	0-120-400-722	0-120-400-726	0-120-400-728	0-120-400-758	0-120-400-764
0-120-400-767	0-120-400-771	0-120-400-803	0-120-400-808	0-120-400-815	0-120-400-840
0-120-400-852	0-120-400-858	0-120-400-869	0-120-400-912	0-120-450-001	

FORD

E8GY-10346A E8GY-10346B E9BZ-10346A

HYUNDAI

37300-21013 37300-21320 37900-21030

MANDO

AR160A

## VR-B192

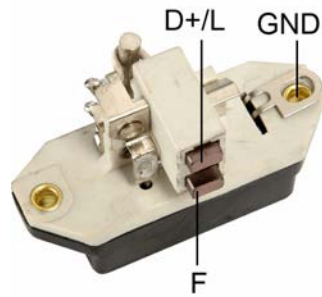

\*For 32mm OD slip ring  
\*Voltage Set Point:14.7V

### Replaces

#### AUDI/VW :

028903803A	049903803B	049903803E	049903803F	059903803B	059903803C
070903803A	52903803	53903803	63903803		

#### BOSCH :

0-192-052-001	0-192-052-002	0-192-052-003	0-192-052-004	0-192-052-005	0-192-052-006
0-192-052-008	0-192-052-011	0-192-052-012	0-192-052-013	0-192-052-014	0-192-052-017
0-192-052-018	0-192-052-019	0-192-052-022	0-192-052-026	0-192-052-028	0-192-052-031

#### FIAT :

4475269	9927829	9934791			
---------	---------	---------	--	--	--

#### FORD :

1477502	71BB-10316AA				
---------	--------------	--	--	--	--

#### MAGIRUS-DEUTZ :

42484638

#### MAGNETI MARELLI :

64808010	64808011	64808100	RTT110A	RTT110AB	RTT110ABT
----------	----------	----------	---------	----------	-----------

#### MERCEDES-BENZ :

21540606	21541806	21542506	21545806		
----------	----------	----------	----------	--	--

#### OPEL :

1204244

#### VALEO :

505055

#### VALEO(MOTOROLA) :

9RC7062

#### VOLVO :

244332

### Unit no.

#### BOSCH

0-120-339-526	0-120-339-527	0-120-339-528	0-120-489-293	0-120-489-309	0-120-489-475
0-120-489-501	0-120-489-519	0-120-489-521	0-120-489-523	0-120-489-532	0-120-489-534
0-120-489-544	0-120-489-550	0-120-489-556	0-120-489-582	0-120-489-587	0-120-489-588
0-120-489-590	0-120-489-602	0-120-489-608	0-120-489-609	0-120-489-610	0-120-489-615
0-120-489-620	0-120-489-621	0-120-489-622	0-120-489-627	0-120-489-628	0-120-489-629
0-120-489-630	0-120-489-641	0-120-489-642	0-120-489-649	0-120-489-650	0-120-489-651
0-120-489-652	0-120-489-655	0-120-489-657	0-120-489-660	0-120-489-683	0-120-489-685
0-120-489-686	0-120-489-687	0-120-489-711	0-120-489-712	0-120-489-735	0-120-489-742
0-120-489-751	0-120-489-775	0-120-489-818	0-120-489-819	0-120-489-822	0-120-489-826
0-120-489-830	0-120-489-832	0-120-489-834	0-120-489-835	0-120-489-843	0-120-489-860
0-120-489-864	0-120-489-867	0-120-489-874	0-120-489-875	0-120-489-876	0-120-489-877
0-120-489-897	0-120-489-898	0-120-489-955	0-120-489-957	9-120-143-216	

## VR-B193M

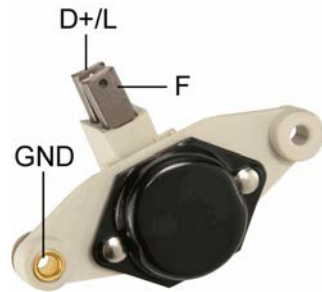

- \*A-Circuit
- \*VR-B193M:V Setting 14.7V
- \*VR-B193ML:V Setting 14.2V
- \*VR-B193MA:V Setting 15.0V
- \*VR-B193MH:Heavy duty;V Setting 14.7V
- \*For 32mm OD slip ring

### Replaces

#### ALFA ROMEO :

7001656

#### BMW :

12311268073    12311268387    12311286073    12311710732

#### BOMAG :

5710950    5710957

#### BOSCH :

1197311000    1197311001    1197311002    1197311090    0192052003    0192052018

2197311090

#### DELCO :

9009353

#### DELCO REMY (LUCAS) :

21221347

#### FENDT :

K830060011010

#### FIAT :

42490291    4474755    4731653    82302913    9933186    9936532

9940343    9950085

#### FORD :

5011364    6036646    6057627    74GB-10316AA    78GB-10316AA    81DB-110316AA

A830X-10316FA

#### GM :

90009353

#### IHC :

3079037R91    3079123R91

#### ISKRA :

10-120-110    11-125-003    11-125-040    11-125-049    11-125-073    11-125-117

11-125-121    AER1503    AER1527    AER7201    AER7207    NRE121301

#### JOHN DEERE :

AL36101    AZ24490

#### KLOCKNER-HUMBOL-DEUTZ :

1173068    1177496    1306557    1320407    8122153

#### LAMBORGHINI :

294295100    294390903    296195100

#### LUCAS :

1221152    21221347    21221373    21221411    21931009    UCB400

UCB412

#### MAGNETI MARELLI :

64808012    64808109

#### MAN :

81256016020

#### MASSEY FERGUSON :

3188023M1

#### MERCEDES-BENZ :

21543206

#### OPEL :

1204246    1204252

#### SAAB :

8558306    8559577    8581779

#### SEAT :

3894469    3899291    NG98102329

#### STEYR :

30800090740    61000090742

#### VALEO :

505-055    NB411

## VR-B193M

Unit no.

BOSCH

0-120-339-515	0-120-339-516	0-120-339-521	0-120-339-531	0-120-469-501	0-120-469-502
0-120-469-503	0-120-469-504	0-120-469-505	0-120-469-513	0-120-469-514	0-120-469-515
0-120-469-524	0-120-469-525	0-120-469-528	0-120-469-533	0-120-469-538	0-120-469-539
0-120-489-050	0-120-489-500	0-120-489-508	0-120-489-509	0-120-489-510	0-120-489-511
0-120-489-520	0-120-489-526	0-120-489-527	0-120-489-535	0-120-489-541	0-120-489-542
0-120-489-546	0-120-489-547	0-120-489-548	0-120-489-557	0-120-489-558	0-120-489-559
0-120-489-560	0-120-489-561	0-120-489-562	0-120-489-567	0-120-489-568	0-120-489-569
0-120-489-581	0-120-489-592	0-120-489-593	0-120-489-594	0-120-489-595	0-120-489-600
0-120-489-601	0-120-489-606	0-120-489-607	0-120-489-613	0-120-489-614	0-120-489-616
0-120-489-617	0-120-489-618	0-120-489-619	0-120-489-623	0-120-489-624	0-120-489-631
0-120-489-632	0-120-489-646	0-120-489-647	0-120-489-648	0-120-489-653	0-120-489-654
0-120-489-659	0-120-489-664	0-120-489-665	0-120-489-666	0-120-489-667	0-120-489-668
0-120-489-669	0-120-489-670	0-120-489-671	0-120-489-698	0-120-489-699	0-120-489-713
0-120-489-714	0-120-489-715	0-120-489-716	0-120-489-717	0-120-489-718	0-120-489-720
0-120-489-732	0-120-489-743	0-120-489-744	0-120-489-745	0-120-489-746	0-120-489-747
0-120-489-748	0-120-489-749	0-120-489-753	0-120-489-755	0-120-489-758	0-120-489-771
0-120-489-772	0-120-489-774	0-120-489-777	0-120-489-778	0-120-489-782	0-120-489-783
0-120-489-785	0-120-489-786	0-120-489-788	0-120-489-797	0-120-489-798	0-120-489-800
0-120-489-805	0-120-489-806	0-120-489-820	0-120-489-821	0-120-489-823	0-120-489-824
0-120-489-828	0-120-489-841	0-120-489-843	0-120-489-844	0-120-489-849	0-120-489-850
0-120-489-857	0-120-489-858	0-120-489-859	0-120-489-865	0-120-489-866	0-120-489-868
0-120-489-869	0-120-489-870	0-120-489-871	0-120-489-872	0-120-489-873	0-120-489-892
0-120-489-893	0-120-489-896	0-120-489-913	0-120-489-914	0-120-489-915	0-120-489-916
0-120-489-937	0-120-489-938	0-120-489-942	0-120-489-943		

ISKRA

11201068	11201071	11201077	11201078	11201117	11201143
11201146	11201147	11201167	11201220	11201222	AAK1114
AAK1117	AAK1118	AAK1119	AAK1137	AAK1148	AAK1151
AAK1152	AAK1163	AAK1182	AAK1183	AAK1185	

## VR-B194

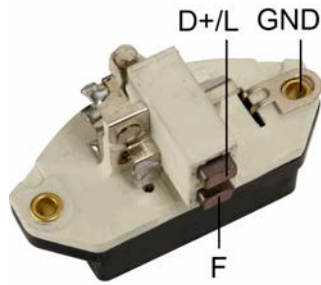

- \*A-Circuit
- \*VR-B194:V Setting 14.7V
- \*VR-B194L:V Setting 14.2V
- \*For 28mm OD slip ring

### Replaces

#### BOSCH :

0-192-052-015	0-192-052-016	0-192-052-020	0-192-052-021	0-192-052-024	0-192-052-025
0-192-052-027	0-192-052-029	0-192-052-032	0-192-052-035	9-190-067-001	9-190-067-003
9-190-067-005	9-190-067-011				

#### IHC :

3079412R92

#### ISKRA :

11-125-094      AER1519

#### JOHN DEERE :

AL30420      AL35999      AL65077

#### KLOCKNER-HUMBOL-DEUTZ :

1308784

#### MERCEDES-BENZ :

21544006

#### SAAB :

8559585

#### SCANIA :

280942

#### VOLVO :

1323467      244489      244612

### Unit no.

#### BOSCH

0-120-468-028	0-120-469-522	0-120-469-532	0-120-469-629	0-120-469-630	0-120-469-687
0-120-469-853	0-120-469-905	0-120-469-956	0-120-484-002	0-120-484-003	0-120-484-017
0-120-488-218	0-120-489-032	0-120-489-156	0-120-489-317	0-120-489-387	0-120-489-658
0-120-489-703	0-120-489-704	0-120-489-708	0-120-489-709	0-120-489-723	0-120-489-724
0-120-489-725	0-120-489-726	0-120-489-729	0-120-489-737	0-120-489-757	0-120-489-779
0-120-489-891	0-120-489-900	0-120-489-902	0-120-489-995	0-120-489-996	9-120-060-910

## VR-B195M

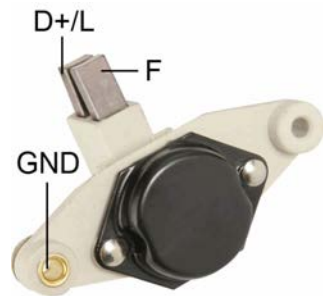

- \*V setting 14.7V
- \*VR-B195ML:V setting 14.2V
- \*VR-B195MA:V setting 15.0V
- \*VR-B195MH:Heavy duty;V setting 14.7V
- \*For 28mm OD slip ring

### Replaces

#### AUDI/VW :

068903803B      068903803D      68903803      J2700004010

#### BMW :

12311726002

#### BOSCH :

1-197-311-004    1-197-311-005    1-197-311-006    1-197-311-010    1-197-311-011    1-197-311-012

1-197-311-013    1-197-311-021    1-197-311-024    1-197-311-028    9-191-337-303

#### DELCO REMY (LUCAS) :

21221432

#### FIAT :

60743997      60751439      9938171      9942848      9942885      9960176

#### FORD :

1640169      6113735      82BB-10316AA    E5RD-10316BA

#### GM :

90349704      90349907

#### KLOCKNER-HUMBOL-DEUTZ :

1318548      8121111

#### LUCAS :

21221349      UCB403

#### OPEL :

1204253      1204256      1204259      90007041      90349704

#### PORSCHE :

92860315300    94460314100    94460314101

#### SEAT :

3899919

## VR-B195M

Unit no.

BOSCH

0-120-468-001	0-120-468-002	0-120-468-003	0-120-468-004	0-120-468-005	0-120-468-007
0-120-468-008	0-120-468-013	0-120-468-014	0-120-468-017	0-120-468-018	0-120-468-019
0-120-468-020	0-120-468-022	0-120-468-023	0-120-468-025	0-120-468-026	0-120-468-027
0-120-468-029	0-120-468-030	0-120-468-031	0-120-468-032	0-120-468-033	0-120-468-042
0-120-468-043	0-120-468-050	0-120-468-051	0-120-468-052	0-120-468-056	0-120-468-062
0-120-468-064	0-120-468-067	0-120-468-068	0-120-468-074	0-120-468-102	0-120-468-103
0-120-469-541	0-120-469-542	0-120-469-545	0-120-469-546	0-120-469-548	0-120-469-551
0-120-469-552	0-120-469-553	0-120-469-554	0-120-469-556	0-120-469-558	0-120-469-559
0-120-469-560	0-120-469-561	0-120-469-566	0-120-469-581	0-120-469-582	0-120-469-586
0-120-469-588	0-120-469-593	0-120-469-594	0-120-469-595	0-120-469-600	0-120-469-603
0-120-469-604	0-120-469-606	0-120-469-607	0-120-469-610	0-120-469-617	0-120-469-618
0-120-469-619	0-120-469-621	0-120-469-622	0-120-469-623	0-120-469-624	0-120-469-631
0-120-469-632	0-120-469-633	0-120-469-636	0-120-469-637	0-120-469-638	0-120-469-648
0-120-469-649	0-120-469-661	0-120-469-662	0-120-469-671	0-120-469-672	0-120-469-674
0-120-469-675	0-120-469-689	0-120-469-690	0-120-469-696	0-120-469-697	0-120-469-698
0-120-469-700	0-120-469-701	0-120-469-702	0-120-469-705	0-120-469-706	0-120-469-707
0-120-469-708	0-120-469-709	0-120-469-711	0-120-469-712	0-120-469-721	0-120-469-727
0-120-469-728	0-120-469-729	0-120-469-731	0-120-469-732	0-120-469-733	0-120-469-734
0-120-469-735	0-120-469-739	0-120-469-740	0-120-469-741	0-120-469-742	0-120-469-743
0-120-469-749	0-120-469-754	0-120-469-757	0-120-469-758	0-120-469-759	0-120-469-768
0-120-469-775	0-120-469-776	0-120-469-777	0-120-469-778	0-120-469-779	0-120-469-782
0-120-469-783	0-120-469-800	0-120-469-802	0-120-469-804	0-120-469-805	0-120-469-808
0-120-469-809	0-120-469-810	0-120-469-822	0-120-469-823	0-120-469-831	0-120-469-839
0-120-469-845	0-120-469-846	0-120-469-864	0-120-469-865	0-120-469-868	0-120-469-869
0-120-469-902	0-120-469-903	0-120-469-910	0-120-469-914	0-120-469-918	0-120-469-919
0-120-469-922	0-120-469-924	0-120-469-953	0-120-469-975	0-120-469-976	0-120-469-977
0-120-469-985	0-120-484-004	0-120-484-005	0-120-484-006	0-120-484-008	0-120-484-009
0-120-484-010	0-120-484-012	0-120-484-013	0-120-484-014	0-120-484-157	0-120-484-159
0-120-484-161	0-120-484-165	0-120-484-167	0-120-484-169	0-120-484-171	0-120-484-173
0-120-484-175	0-120-484-191	0-120-484-193	0-120-484-201	0-120-484-203	0-120-484-204
0-120-488-102	0-120-488-103	0-120-488-119	0-120-488-163	0-120-488-167	0-120-488-169
0-120-488-171	0-120-488-202	0-120-488-219	0-120-489-002	0-120-489-003	0-120-489-004
0-120-489-005	0-120-489-006	0-120-489-007	0-120-489-008	0-120-489-009	0-120-489-010
0-120-489-011	0-120-489-014	0-120-489-015	0-120-489-017	0-120-489-028	0-120-489-029
0-120-489-030	0-120-489-031	0-120-489-036	0-120-489-037	0-120-489-038	0-120-489-040
0-120-489-041	0-120-489-042	0-120-489-072	0-120-489-073	0-120-489-076	0-120-489-080
0-120-489-081	0-120-489-090	0-120-489-091	0-120-489-094	0-120-489-104	0-120-489-105
0-120-489-115	0-120-489-128	0-120-489-129	0-120-489-130	0-120-489-131	0-120-489-133
0-120-489-134	0-120-489-152	0-120-489-153	0-120-489-167	0-120-489-170	0-120-489-171
0-120-489-195	0-120-489-196	0-120-489-197	0-120-489-200	0-120-489-205	0-120-489-207
0-120-489-208	0-120-489-209	0-120-489-210	0-120-489-211	0-120-489-228	0-120-489-229
0-120-489-237	0-120-489-244	0-120-489-248	0-120-489-249	0-120-489-282	0-120-489-283
0-120-489-287	0-120-489-296	0-120-489-360	0-120-489-361	0-120-489-362	0-120-489-363
0-120-489-364	0-120-489-365	0-120-489-367	0-120-489-369	0-120-489-370	0-120-489-377
0-120-489-378	0-120-489-379	0-120-489-382	0-120-489-386	0-120-489-418	0-120-489-420
0-120-489-421	0-120-489-423	0-120-489-434	0-120-489-448	0-120-489-455	0-120-489-480
0-120-489-483	0-120-489-484	0-120-489-549	0-120-489-888	0-120-489-889	0-120-489-903
0-120-489-904	0-120-489-905	0-120-489-906	0-120-489-961	0-120-489-966	0-120-489-967
0-120-489-968	0-120-489-976	0-120-489-980	0-120-489-981	0-120-489-982	0-120-489-983
0-120-489-986	0-120-489-987	0-120-489-992	0-120-489-993		

## VR-B196M

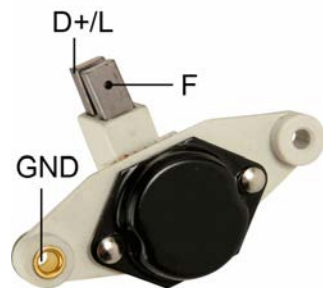

\*With Resistor  
 \*For 28mm OD slip ring  
 \*VR-B196M:V Setting 14.7V  
 \*VR-B196ML:V Setting 14.2V

### Replaces

#### BMW :

12311279548      12321271644      12321711399      1711391

#### BOSCH :

1197311003      1197311007      1197311009      1197311018      1197311023      1197311039  
 1197311008      1197311022      1197311035      1197311800      2197311022      137127  
 2197311008

#### DELCO REMY (LUCAS) :

21221416

#### FERRARI :

0121840

#### FIAT :

60743883

#### FORD :

86GB10316AA

#### LUCAS :

21221412      UCB413      21221416

#### MERCEDES-BENZ :

21544106      21545106      21547206

#### PEUGEOT :

5761.47      5761.59

#### SAAB :

8559619      8571846

#### SEAT :

3980592

### Unit no.

#### BOSCH

0-120-468-009	0-120-468-010	0-120-468-011	0-120-468-015	0-120-468-016	0-120-468-035
0-120-468-036	0-120-468-045	0-120-468-046	0-120-468-059	0-120-469-543	0-120-469-544
0-120-469-545	0-120-469-547	0-120-469-555	0-120-469-557	0-120-469-563	0-120-469-564
0-120-469-567	0-120-469-568	0-120-469-583	0-120-469-584	0-120-469-589	0-120-469-608
0-120-469-609	0-120-469-611	0-120-469-620	0-120-469-644	0-120-469-645	0-120-469-664
0-120-469-665	0-120-469-668	0-120-469-669	0-120-469-670	0-120-469-680	0-120-469-681
0-120-469-682	0-120-469-683	0-120-469-684	0-120-469-685	0-120-469-744	0-120-469-745
0-120-469-785	0-120-469-786	0-120-469-787	0-120-469-793	0-120-469-811	0-120-469-812
0-120-469-881	0-120-469-882	0-120-469-896	0-120-469-897	0-120-469-927	0-120-469-928
0-120-469-935	0-120-469-992	0-120-469-993	0-120-488-120	0-120-488-121	0-120-488-122
0-120-489-006	0-120-489-025	0-120-489-026	0-120-489-061	0-120-489-064	0-120-489-065
0-120-489-066	0-120-489-069	0-120-489-070	0-120-489-078	0-120-489-079	0-120-489-149
0-120-489-150	0-120-489-183	0-120-489-184	0-120-489-189	0-120-489-190	0-120-489-232
0-120-489-233	0-120-489-234	0-120-489-242	0-120-489-253	0-120-489-254	0-120-489-259
0-120-489-274	0-120-489-275	0-120-489-286	0-120-489-294	0-120-489-325	0-120-489-326
0-120-489-327	0-120-489-328	0-120-489-330	0-120-489-354	0-120-489-355	0-120-489-356
0-120-489-357	0-120-489-358	0-120-489-395	0-120-489-404	0-120-489-405	0-120-489-451
0-120-489-452	0-120-489-881	0-120-489-882	0-120-489-917	0-120-489-918	0-120-489-928
0-120-489-930	0-120-489-932	0-120-489-933	0-120-489-935	0-120-489-936	0-120-489-971
0-120-489-972	0-120-489-974	0-120-489-975	0-120-489-997		



## VR-B196MH



- \*For 28mm OD slip ring
- \*With 68 ohm Resistor
- \*Heavy duty type
- \*Voltage Set Point:14.7V

### Replaces

#### AUDI/VW :

34903803

#### BOSCH :

1-197-311-008

1-197-311-022

1-197-311-026

1-197-311-027

1-197-311-035

1-197-311-038

1-197-311-040

1-197-311-041

1-197-311-050

1-197-311-800

#### CITROEN :

9405761558

#### FORD :

6165056

86GB-10316AA

#### MERCEDES-BENZ :

21547902

21547906

#### PEUGEOT :

5761.55

#### PORSCHE :

96460314100

#### SAAB :

8590549

#### VOLVO :

1324617

3523710-6

## VR-B197

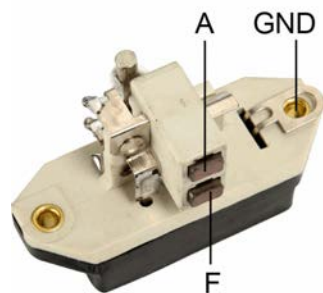

\*24V  
 \*For 32mm OD slip ring  
 \*Voltage Set Point:28.3V

### Replaces

#### BOSCH :

0-192-053-001    0-192-053-002    0-192-053-004    0-192-053-007    0-192-053-008    0-192-053-027

#### FIAT :

4701484            79022473            9988935

#### IHC :

3079147R91

#### ISKRA :

11-125-004            11-125-055            AER1403            AER1504            AER1507

#### IVECO :

9988935

#### KLOCKNER-HUMBOL-DEUTZ :

1306480            4701484            8122154

#### LUCAS :

21221125            21221348            UCB402

#### MAGIRUS-DEUTZ :

4701484

#### MAGNETI MARELLI :

64800007

#### MAN :

81256016013            81256016017

#### STEYR :

61500090706

#### VALEO :

505059            NB412

#### VALEO(MOTOROLA) :

9RC8090

#### VOLVO :

244344            244426

### Unit no.

#### BOSCH

0-120-339-537    0-120-339-538    0-120-469-509    0-120-489-481    0-120-489-638    0-120-489-639

0-120-489-640    0-120-489-661    0-120-489-682    0-120-489-793    0-120-489-794    0-120-489-795

0-120-489-796    9-120-144-101    9-120-144-102    9-120-144-103    9-120-144-104    9-120-144-105

9-120-144-106    9-120-144-107    9-120-144-109    9-120-144-110

## VR-B198

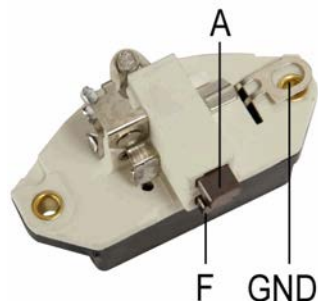

\*24V  
 \*For 28mm OD slip ring  
 \*Voltage Set Point:28.3V

### Replaces

#### BOSCH :

0192053005	0192053006	0192053011	0192053013	0192053016	0192053017
0192053018	0192053019	0192053022	0192053023		

#### DELCO REMY (LUCAS) :

21221350

#### FORD :

6094906

#### IHC :

3079392R91

#### ISKRA :

11-125-095      AER1520

#### IVECO :

79078923

#### KLOCKNER-HUMBOLD-DEUTZ :

1171370      8122152

#### LIEBHERR :

5004185      5603582

#### LUCAS :

21931011      UCB404

#### MAN :

81256016014	81256016016	81256016023	81256016024	81256016027	81256016031
-------------	-------------	-------------	-------------	-------------	-------------

#### MERCEDES-BENZ :

21543806	21543906	21544706	21544906	21546406	21546706
----------	----------	----------	----------	----------	----------

21547606

#### SONACOME :

1117344

#### STEYR :

61200090707	61500090729
-------------	-------------

### Unit no.

#### BOSCH

0-120-468-037	0-120-469-518	0-120-469-519	0-120-469-520	0-120-469-521	0-120-469-523
0-120-469-527	0-120-469-549	0-120-469-562	0-120-469-569	0-120-469-580	0-120-469-585
0-120-469-592	0-120-469-653	0-120-469-686	0-120-469-691	0-120-469-753	0-120-469-773
0-120-469-807	0-120-469-843	0-120-469-849	0-120-469-851	0-120-469-855	0-120-469-890
0-120-469-959	0-120-488-125	0-120-488-133	0-120-488-136	0-120-488-137	0-120-488-232
0-120-489-023	0-120-489-033	0-120-489-034	0-120-489-035	0-120-489-053	0-120-489-055
0-120-489-071	0-120-489-221	0-120-489-225	0-120-489-230	0-120-489-231	0-120-489-284
0-120-489-320	0-120-489-412	0-120-489-413	0-120-489-643	0-120-489-684	0-120-489-702
0-120-489-707	0-120-489-727	0-120-489-730	0-120-489-733	0-120-489-885	0-120-623-052
0-120-689-502	0-120-689-504	0-120-689-505	0-120-689-506	0-120-689-507	0-120-689-508
0-120-689-510	0-120-689-511	0-120-689-513	0-120-689-514	0-120-689-516	0-120-689-517
0-120-689-520	0-120-689-521	0-120-689-522	0-120-689-523	0-120-689-525	0-120-689-526
0-120-689-527	0-120-689-528	9-120-144-121	9-120-144-125	9-120-144-130	9-120-144-133

**VR-B199-3**



\*24V  
\*Voltage Set Point:28.3V

**Replaces**

**BOSCH :**

0-192-033-001    0-192-033-002    0-192-033-004

**FORD :**

11635831

**IHC :**

3055449R91    3132862R1

**KLOCKNER-HUMBOL-DEUTZ :**

114440747    1161178    2404414    B25N92117J    N92117T1    S1H7615

**LANCIA :**

82243312    82294110

**LIEBHERR :**

6000094    6912707

**LUCAS :**

21931016    NCB407

**MAGNETI MARELLI :**

64800004

**MAN :**

30535010001    51256017029    51256017036    51256017041    51256017046    81256010008

81256010014    81256016007

**MASSEY FERGUSON :**

2945680M1

**MERCEDES-BENZ :**

11547006    11548106    11549106    21540506

**RENAULT :**

7701008802

**SCANIA :**

225662

**STEYR :**

610090021

**VERSORGUNGS :**

2920-12-158-8890

**VOLVO :**

102746

**VOLVO/DAF :**

241630    249264    870864

**VR-B199-3A**

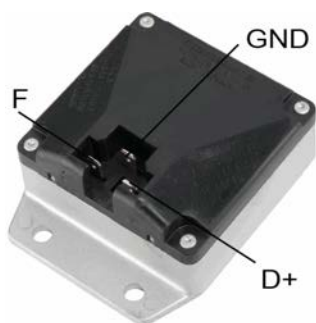

\*Voltage Set Point:14.5V

**Replaces**

**BOSCH :**

9-190-087-005

## VR-B199-4

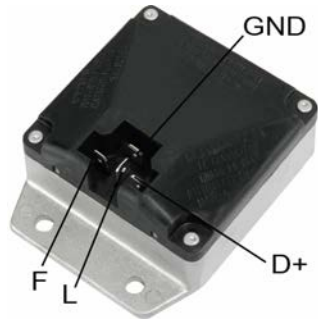

\*24V  
\*Voltage Set Point:28.3V

### Replaces

#### BOSCH :

0-192-033-003    0-192-033-005

#### FAUN :

1713071

#### IHC :

3144931R1

#### KLOCKNER-HUMBOL-DEUTZ :

1162829            2404417            8122110            S4H7615

#### LANCIA :

82301179

#### LIEBHERR :

6201558            6912701

#### LUCAS :

21931015            NCB406

#### MAGIRUS-DEUTZ :

1162829

#### MAGNETI MARELLI :

64800005

#### MAN :

81256010010        81256010011        90801101322

#### MASSEY FERGUSON :

2868511M91

#### MERCEDES-BENZ :

11548806            21540206            3505477102

#### RENAULT :

26563108            7701012214            7701015670

#### VOLVO/DAF :

4785003

## VR-B200H



- \*A-Circuit
- \*w/o resistor
- \*Heavy Duty
- \*Voltage Set Point:14.6V

### Replaces

#### AUDI/VW :

021903803B      028903803B      028903803C      78903803

#### BOSCH :

1197311212	1197311223	1197311224	1197311225	1197311227	1197311236
1197311238	1197311175	1197311277	1197311548	1127311527	1197311527
1197311540	1197311214	1197311220	1197311221	1197311222	1197311228
1197311229	1197311232	1197311233	1197311235	1197311237	1197311241
1197311519	1197311522	1197311528	1197311521		

#### DELCO :

90487255

#### MERCEDES-BENZ :

21548502

#### NISSAN :

23215-72J00

#### VALEO :

572587

### Unit no.

#### BOSCH

0-120-465-007	0-120-465-008	0-120-465-010	0-120-465-020	0-120-465-021	0-120-465-028
0-120-465-031	0-120-485-015	0-120-485-018	0-120-485-023	0-120-485-025	0-120-485-026
0-120-485-034	0-120-485-036	0-120-485-038	0-120-485-039	0-120-485-043	0-120-485-044
0-120-485-048	0-120-505-005	0-123-120-001	0-123-214-002	0-123-310-001	0-123-310-002
0-123-315-001	0-123-315-002	0-123-315-003	0-123-315-006	0-123-340-002	0-123-340-003
0-123-340-005	0-123-505-010	0-123-510-001	0-123-510-062		

**VR-B201H**



\*w/180 ohm resistor  
 \*Heavy Duty  
 \*Voltage Set Point:14.6V

**Replaces**

**BOSCH :**

1197311211	1197311213	1197311217	1197311219	1197311242	1197311533
1197311556					

**MERCEDES-BENZ :**

0021548106	0021548206	0021548506	0021548706	0021549206	0022159106
0031540606					

**PEUGEOT :**

5761.85	5761.86	95644494			
---------	---------	----------	--	--	--

**VALEO :**

3544570

**Unit no.**

**BOSCH**

0-120-465-004	0-120-465-006	0-120-465-012	0-120-465-013	0-120-465-014	0-120-465-015
0-120-465-016	0-120-465-017	0-120-485-011	0-120-485-012	0-120-485-022	0-123-213-007
0-123-315-005					

**VR-B202**



\*For 28mm OD slip ring  
 \*Voltage Set Point:14.7V

**Replaces**

**BOMAG :**

5710956

**BOSCH :**

0192052033	0192053032	1197311031	1197311043	2197311026	2197311028
2197311029	9190087020	9190087023	0192052035	1197311029	1197311030
1197311034	1197311045				

**KLOCKNER-HUMBOL-DEUTZ :**

1173069	1177145	1178644			
---------	---------	---------	--	--	--

**MERCEDES-BENZ :**

1541805	21543706				
---------	----------	--	--	--	--

**Unit no.**

**BOSCH**

0-120-469-526	0-120-469-540	0-120-469-762	0-120-484-001	0-120-484-017	0-120-488-185
0-120-488-209	0-120-489-022	0-120-489-315	0-120-489-710	0-120-489-756	

**VR-B202L**

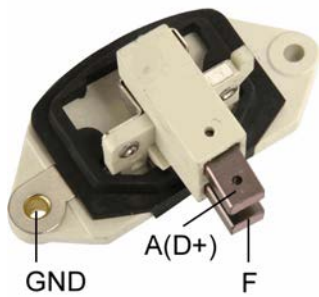

\*For 28mm OD slip ring  
 \*Voltage Set Point: 14.2V  
 \*Same as VR-B202 but with lower volts setting

**Replaces**

**BOSCH :**

0192052033	0192052035	0192053032	1197311029	197311030	1197311031
1197311034	1197311043	1197311045	2197311026	2197311028	2197311029
9190087020	9190087023				

**KLOCKNER-HUMBOL-DEUTZ :**

1173069	1177145	1178644
---------	---------	---------

**MERCEDES-BENZ :**

1541805	21543706
---------	----------

**Unit no.**

**BOSCH**

0-120-469-526	0-120-469-540	0-120-469-526	0-120-484-001	0-120-484-017	0-120-488-185
0-120-488-209	-120-489-022	0-120-489-315	0-120-489-710	0-120-489-756	

**VR-B203**

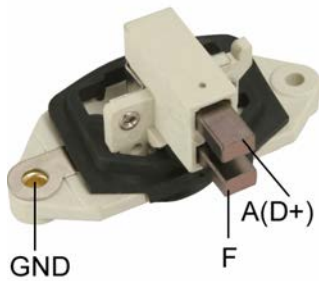

\*A-Circuit  
 \*24V  
 \*For 28mm OD slip ring  
 \*Volts setting 28.3V

**Replaces**

**BOSCH :**

1197311300	1197311301	1197311304	0192053011	1197311305	1197311306
1197311307	2197311301	6033RD0002			

**KLOCKNER-HUMBOL-DEUTZ :**

1178336

**MERCEDES-BENZ :**

1541705	21548406
---------	----------

**SCANIA :**

117253	305160	362645
--------	--------	--------

**VOLVO :**

1606935	1625880	1698185	3239266	9600908
---------	---------	---------	---------	---------

**Unit no.**

**BOSCH**

0-120-468-053	0-120-468-065	0-120-468-066	0-120-469-518	0-120-469-549	0-120-469-562
0-120-469-569	0-120-469-634	0-120-469-643	0-120-469-673	0-120-469-761	0-120-469-763
0-120-469-797	0-120-469-891	0-120-469-900	0-120-469-920	0-120-469-959	0-120-469-960
0-120-488-153	0-120-488-224	0-120-489-192	0-120-489-303	0-120-489-316	0-120-489-411
0-120-489-643	0-120-489-728	0-120-489-730	0-120-489-731	0-120-489-827	0-120-489-886
0-120-489-944	9-120-144-116	9-120-144-117	9-120-144-119	9-120-144-120	9-120-144-122
9-120-144-123	9-120-144-127	9-120-144-129	9-120-144-131	9-120-144-132	



## VR-B204

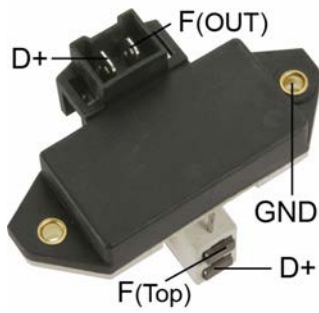

\*For 28mm OD slip ring  
\*Voltage Set Point:14.7V

### Replaces

**BOSCH :**  
0-192-052-023

### Unit no.

BOSCH  
0-120-489-059    0-120-489-999    9-120-144-219    9-120-144-220    9-120-144-232    9-120-144-233

## VR-B205



\*A-Circuit  
\*For 28mm OD slip ring  
\*Voltage Set Point:14.7V

### Replaces

**BOSCH :**  
0-192-052-030  
**TALBOT :**  
43269200

### Unit no.

BOSCH  
9-120-144-231

## VR-B206

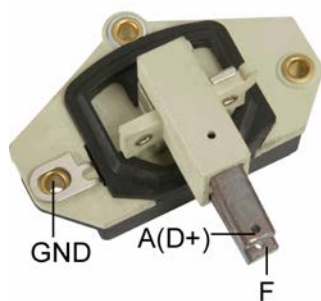

\*24V  
 \*For 28mm OD slip ring  
 \*Voltage Set Point:28.3V

### Replaces

#### BOSCH :

0-192-053-003    0-192-053-009    0-192-053-012    0-192-053-014    0-192-053-025    1-197-311-315

#### IVECO :

93157259

#### KLOCKNER-HUMBOL-DEUTZ :

1320082            1320381            8122275

#### MAN :

81256016015    81256016021    81256016025    81256016030

#### MERCEDES-BENZ :

21543506            21545506            21546806

#### VOLVO :

1698764

### Unit no.

#### BOSCH

0-120-689-503    0-120-689-512    0-120-689-515

## VR-B207

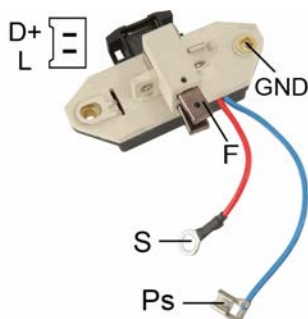

\*For 28mm OD slip ring  
 \*Voltage Set Point:14.7V

### Replaces

#### BOSCH :

9-191-337-302    9-191-337-306

### Unit no.

#### BOSCH

9-120-144-257    9-120-144-258    9-120-144-260    9-120-144-262    9-120-144-264    9-120-144-267  
 9-120-144-268    9-120-144-272    9-120-144-274    9-120-144-276    9-120-144-278    9-120-144-284  
 9-120-144-286    9-120-144-298    9-120-144-303

## VR-B208H

\*Same as VR-B201H except with 68 Ohm Resistor  
 \*Voltage Set Point: 14.6V

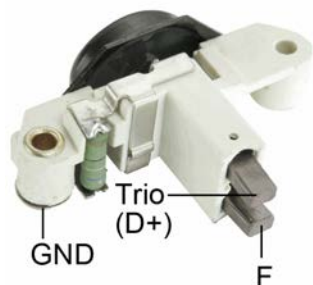

### Replaces

#### BOSCH :

1-197-311-234    1-197-311-239    1-197-311-514

### Unit no.

#### BOSCH

0-120-465-006    0-123-510-017    0-123-545-003

## VR-B209

\*24V  
 \*Same as VR-B203 but with higher volts setting(28.5V)

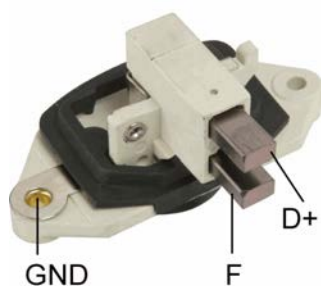

### Replaces

#### BOSCH :

1197311304    1197311324    6033RD2006

#### MERCEDES-BENZ :

21548406

#### SCANIA :

117253    362645

#### VOLVO :

1606935    1625880

### Unit no.

#### BOSCH

0-120-468-065	0-120-468-066	0-120-468-093	0-120-468-094	0-120-468-114	0-120-468-116
0-120-468-118	0-120-468-124	0-120-468-129	0-120-468-130	0-120-469-010	0-120-469-014
0-120-469-018	0-120-469-022	0-120-469-023	0-120-469-031	0-120-469-523	0-120-469-549
0-120-469-569	0-120-469-673	0-120-469-679	0-120-469-763	0-120-469-798	0-120-469-900
0-120-469-959	0-120-469-960	0-120-469-978	0-120-469-999		

## VR-B210

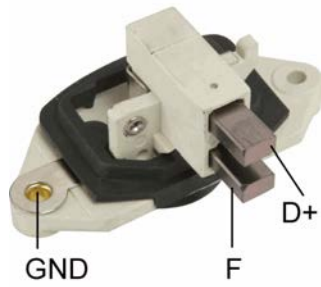

- \*A-Circuit
- \*24V
- \*Same as VR-B203 but with higher volts setting(29.0V)

### Replaces

**BOSCH :**  
1-197-311-309

### Unit no.

BOSCH					
0-120-468-053	0-120-468-065	0-120-468-066	0-120-469-518	0-120-469-549	0-120-469-562
0-120-469-569	0-120-469-634	0-120-469-643	0-120-469-673	0-120-469-761	0-120-469-763
0-120-469-797	0-120-469-891	0-120-469-900	0-120-469-920	0-120-469-959	0-120-469-960
0-120-488-153	0-120-488-224	0-120-489-192	0-120-489-303	0-120-489-316	0-120-489-411
0-120-489-643	0-120-489-728	0-120-489-730	0-120-489-731	0-120-489-827	0-120-489-886
0-120-489-944	9-120-144-116	9-120-144-117	9-120-144-119	9-120-144-120	9-120-144-122
9-120-144-123	9-120-144-127	9-120-144-129	9-120-144-131	9-120-144-132	

## VR-B211

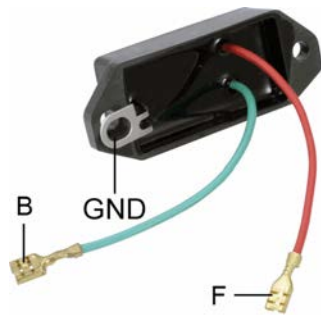

\*Voltage Set Point:14.2V

### Replaces

**BOSCH :**  
9-121-080-303    9-190-087-003

**VW/BRAZIL :**  
409038031

### Unit no.

BOSCH			
9-120-080-061	9-120-080-072	9-120-080-090	9-120-080-122

## VR-B212

\*Voltage Set Point:14.7V

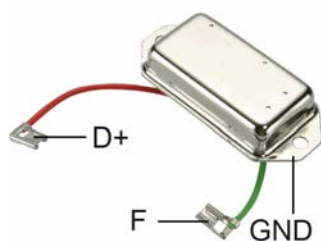

### Replaces

**BOSCH :**

9-190-457-006

### Unit no.

BOSCH

9-120-450-044	9-120-450-071	9-120-450-077	9-120-450-085	9-120-450-090	9-120-450-092
9-120-450-100	9-120-450-102	9-120-450-105	9-120-450-107	9-120-450-113	9-120-450-118
9-120-450-119	9-120-450-131				

## VR-B213

\*Voltage Set Point:14.2V

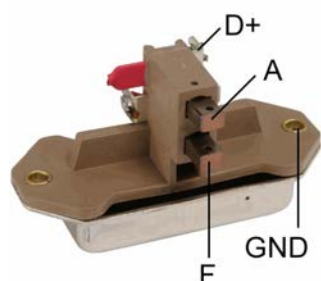

### Unit no.

BOSCH

9-120-450-041	9-120-450-043	9-120-450-073	9-120-450-078	9-120-450-084	9-120-450-086
9-120-450-087	9-120-450-088	9-120-450-089	9-120-450-094	9-120-450-096	9-120-450-110
9-120-450-125	9-120-450-126	9-120-450-129	9-120-450-133		

## VR-B215

\*Electronic Type  
\*Voltage Set Point:14.5V



### Replaces

**BOSCH :**

9-190-455-001    9-190-455-009

## VR-B217H

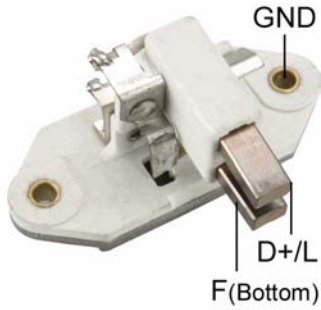

- \*A-Circuit
- \*Heavy Duty
- \*Voltage Set Point:14.2V

**Replaces**

**BOSCH :**  
9-190-087-040

## VR-B218

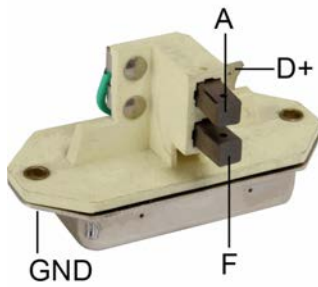

- \*Voltage Set Point:14.2V

**Replaces**

**BOSCH :**  
9-190-457-002

**Unit no.**

**BOSCH**  
9-120-450-006    9-120-450-134    9-120-450-137    9-120-456-024

## VR-B219

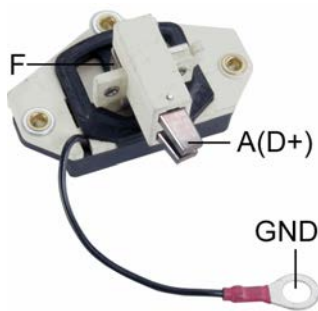

- \*24V
- \*For 28mm OD slip ring
- \*Bus Type Regulator
- \*Scania Autobus with Mercedes Engine
- \*Voltage Set Point:28.3V

**Replaces**

**BOSCH :**  
9190457003    192053021    1197311319    1197311320    9152053021    9190457048

**Unit no.**

**BOSCH**  
9-120-456-003    9-120-456-014    9-120-456-016    9-120-456-028

## VR-B220

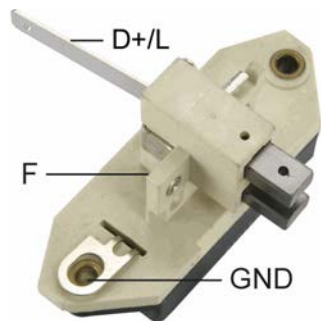

\*A-Circuit  
\*Voltage Set Point:14.7V

### Replaces

**BOSCH :**  
0192052007      1197311047      9191337311      0192052010

**LUCAS :**  
UCB407

**MAGNETI MARELLI :**  
940038005

### Unit no.

**BOSCH**  
0-120-489-506      0-120-489-565      0-986-031-120

## VR-B221



\*A-Circuit  
\* L Terminal Drives Choke  
\*Soft Start  
\*8.5 sec. LRC  
\*Voltage Set Point:14.4V

### Replaces

**BOSCH :**  
F-00M-145-229      F-00M-A45-207      F-00M-145-352      F-00M-145M-230      F-00M-145-210

### Unit no.

**BOSCH**  
0-124-515-017      0-124-515-054      0-124-525-001      0-124-525-014      0-124-525-029      0-124-325-117  
0-124-515-018      0-124-515-019  
**VOLVO**  
9442841

**VR-B222**

\*For 14mm OD slip ring  
\*Voltage Set Point:14.6V

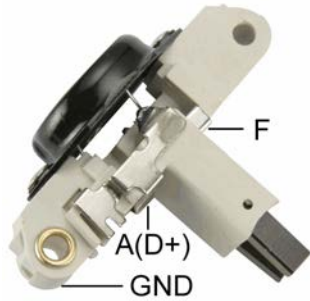

**Replaces**

**AUDI/VW :**  
028903803D

**BOSCH :**  
1197311500      1197311523      1197311530      1197311531      1197311548

**Unit no.**

**BOSCH**  
0-123-325-005    0-123-325-006    0-123-505-011    0-123-505-012    0-123-505-013    0-123-510-046  
0-123-510-047    0-123-515-014    0-123-515-017    0-123-515-018    0-123-515-020    0-123-515-021

**VR-B225**

\*A-Circuit  
\*For 14mm OD slip ring  
\*Voltage Set Point:14.7V



**Replaces**

**BOSCH :**  
1-119-311-231    1-197-311-231

**Unit no.**

**BOSCH**  
0-123-315-020    0-123-315-007

**VR-B226**

\*24V  
\*For 28mm OD slip ring  
\*Voltage Set Point:28.3V



**Replaces**

**BOSCH :**  
9-191-337-310

**Unit no.**

**BOSCH**  
0-120-469-103    6033GB3047



**VR-B229**



\*For 14mm OD slip ring  
\*Voltage Set Point:14.2V

**Replaces**

**BOSCH :**

1-197-311-518    1-197-311-520

**Unit no.**

BOSCH

0-123-315-016    0-123-315-021    0-123-505-014    0-123-505-015    0-123-505-016

**VR-B235**

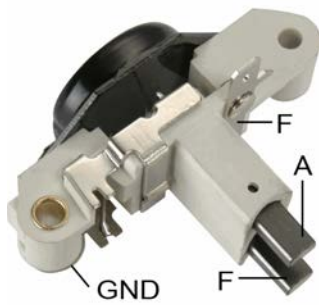

\*For 14mm OD slip ring  
\*Voltage Set Point:14.6V

**Replaces**

**BOSCH :**

1-197-311-511

**Unit no.**

BOSCH

0-123-505-017    0-123-510-007    0-123-510-008    0-123-510-028    0-123-515-003    0-123-515-008  
0-123-515-009    0-123-515-011    0-123-515-012    0-123-515-024    0-123-520-003    0-123-520-004

**VR-B238**



\*A-Circuit  
\*For 14mm OD slip ring  
\*Voltage Set Point:14.5V

**Replaces**

**BOSCH :**

1197311545    1197311506    1197311516    1197311536    1197311545    1197311557

**Unit no.**

BOSCH

0-123-315-013    0-123-325-010    0-123-515-002    0-123-515-004    0-123-515-007    0-123-515-010  
0-123-515-022    0-123-515-023    0-123-515-025    0-123-515-030

## VR-B240H



- \*For 14mm OD slip ring
- \*Low Cut In Speed
- \*VR-B240HL(Volts Setting 14.4V)
- \*Voltage Set Point:14.6V

### Replaces

#### BOSCH :

1-197-311-240	1-197-311-512	1-197-311-551	1-197-311-552	1-197-311-553
---------------	---------------	---------------	---------------	---------------

#### Unit no.

#### BOSCH

0-120-110-007	0-120-335-007	0-120-335-011	0-120-335-012	0-123-310-010	0-123-310-011
0-123-310-012	0-123-310-013	0-123-310-051			

## VR-B242

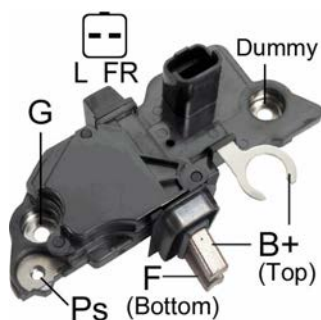

- \*A-Circuit
- \*Active Lamp
- \*Soft Start
- \*8 sec. LRC
- \*Short Circuit Protection
- \*Voltage Set Point:14.5V

### Replaces

#### BOSCH :

F00M141381	F00M145276	F00M145368	F00M144181	F00M145375	F00MA45237
------------	------------	------------	------------	------------	------------

#### Unit no.

#### BOSCH

0-124-525-028	0-124-525-043	0-124-525-044	0-124-525-047	0-124-525-070	0-124-525-076
0-124-525-082					

### Used On

#### RENAULT

Megane II(BM0_,CM0_)	1.9dCi	2002-
----------------------	--------	-------

#### VAUXHALL

Movano Chassis/Cab	2.5 CDTI	2004-
Movano Combi	2.5 CDTI Bus 74 kW	2004-

**VR-B243**



- \*A-Circuit
- \*Active Lamp
- \*Soft Start
- \*5.0 sec. LRC
- \*Short Circuit Protection
- \*Voltage Set Point:14.4V

**Replaces**

**BOSCH :**

F00M145236	F00M145305	F00M145324	F00M145376	F00M145865	F00M145873
F00M145334	F00M145392	F00M145874	F00M145334		

**TOYOTA :**

27700-0L020

**Unit no.**

**BOSCH**

0-120-000-023	0-124-315-015	0-124-315-016	0-124-315-024	0-124-315-025	0-124-315-029
0-124-315-033	0-124-315-034	0-124-315-040	0-124-325-071	0-124-325-079	0-124-325-085
0-124-325-086	0-124-325-123	0-124-325-165	0-124-225-053		

**TOYOTA**

27060-0P010	27060-0J061
-------------	-------------

**Used On**

**TOYOTA**

TACOMA 4.0 6 Cyl.	2007-2009
-------------------	-----------

**VR-B244**

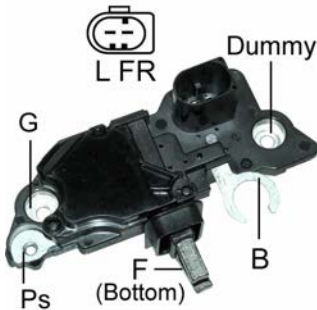

- \*A-Circuit
- \* Soft Start
- \* 2.5 sec. LRC
- \* Soft Start
- \* Short Circuit Protection
- \* Voltage Set Point: 14.2V

**Replaces**

**BOSCH :**

F-00M-145-244

**Unit no.**

**BOSCH**

0-124-225-020

**VR-B247**



- \*A-Circuit
- \*Soft Start
- \*2.5 sec. LRC
- \*Short Circuit Protection
- \*Voltage Set Point:14.5V

**Replaces**

**BOSCH :**

F-00M-145-247    F-00M-145-357    F-00M-144-138    F-00M-144-146    F-00M-145-331    F-00M-145-382

**Unit no.**

**BOSCH**

0-124-325-040    0-124-515-055    0-124-615-012    0-124-515-047    0-124-325-045    0-124-325-108  
 0-124-325-158    0-124-515-048    0-124-515-060    0-124-615-008    0-124-615-013    0-124-615-020  
 0-124-625-005    0-124-625-007

**VR-B250**

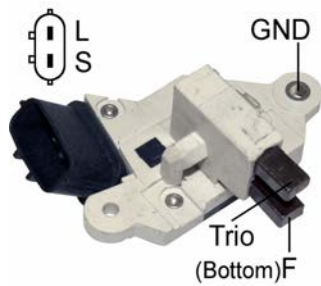

- \*A-Circuit
- \*Voltage Set Point:14.6V

**Replaces**

**BOSCH :**

9-190-041-002

**VR-B251**

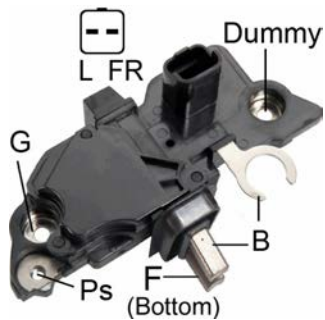

- \*A-Circuit
- \*For 14mm OD slip ring
- \*Voltage Set Point:14.5V

**Replaces**

**BOSCH :**

F-00M-145-239    F-00M-A45-234    F-00M-144-111    F-00M-145-387    F-00M-145-388

**Unit no.**

**BOSCH**

0-124-325-024    0-124-415-007    0-124-415-013    0-124-415-014

**VR-B252**

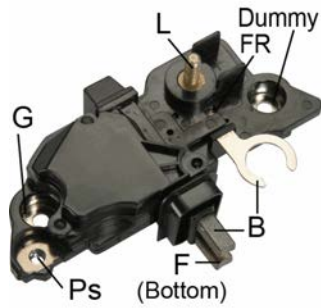

- \*A-Circuit
- \*For 14mm OD slip ring
- \*Soft Start
- \*8.5 sec. LRC
- \*Short Circuit Protection
- \*Voltage Set Point:14.5V

**Replaces**

**BOSCH :**

F-00M-145-201    F-00M-145-231    F-00M-144-142    F-00M-145-257    F-00M-145-282    F-00M-145-370  
 F-00M-145-680    F-00M-145-675    F-00M-145-329    F-00M-144-177

**FIAT :**

9949575

**MERCEDES-BENZ :**

0031541506

**OPEL :**

1204289                      9117942                      9201135                      93176380

**Unit no.**

**BOSCH**

0-124-215-001	0-124-215-003	0-124-225-001	0-124-225-002	0-124-225-004	0-124-225-009
0-124-415-002	0-124-415-005	0-124-415-008	0-124-415-010	0-124-225-001	0-124-225-002
0-124-225-004	0-124-225-009	0-124-225-018	0-124-225-022	0-124-225-023	0-124-225-024
0-124-225-025	0-124-325-023	0-124-325-054	0-124-325-055	0-124-415-001	0-124-415-002
0-124-415-005	0-124-415-008	0-124-415-010	0-124-515-004	0-124-515-005	0-124-515-006
0-124-515-023	0-124-515-031	0-124-515-061	0-124-515-099	0-124-515-100	0-124-525-186
0-124-625-105	0-124-625-123	0-124-625-059			

**VR-B253**

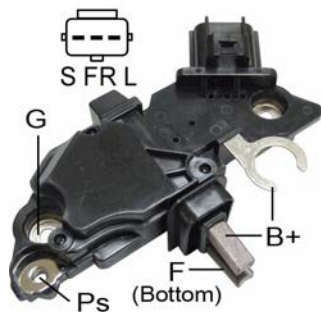

- \*A-Circuit
- \*Soft Start
- \*Short Circuit Protection
- \*Voltage Set Point:14.5V

**Replaces**

**BOSCH :**

F00M145214                      F00M144183                      F00M145348

**Unit no.**

**BOSCH**

0-124-325-063                      0-124-325-064                      0-124-415-006

## VR-B254

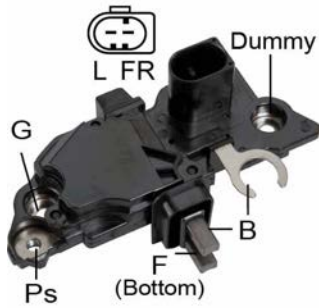

- \*A-Circuit
- \*For 14mm OD slip ring
- \*2.5 Second LRC
- \*Soft Start 30%
- \*Short Circuit Protection
- \*Voltage Set Point:14.5V

### Replaces

#### BOSCH :

F-00M-145-225	F-00M-144-136	F-00M-145-350	F-00M-145-384	F-00M-A45-232	F-00M-145-209
F-00M-145-200	F-00M-145-337				

### Unit no.

#### BOSCH

0-124-215-006	0-124-225-012	0-124-315-001	0-124-315-002	0-124-315-003	0-124-315-004
0-124-315-005	0-124-315-006	0-124-315-007	0-124-315-008	0-124-315-011	0-124-315-012
0-124-315-013	0-124-315-018	0-124-315-020			

## VR-B255

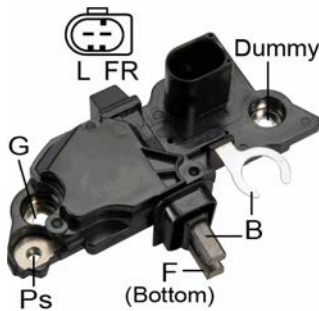

- \*A-Circuit
- \*For 14mm OD slip ring
- \*Soft Start
- \*8.5 Second LRC
- \*Short Circuit Protection
- \*Voltage Set Point:14.5V

### Replaces

#### BOSCH :

F-00M-145-206	F-00M-145-240
---------------	---------------

### Unit no.

#### BOSCH

0-124-325-006	0-124-325-007	0-124-325-011	0-124-515-020	0-124-515-021
---------------	---------------	---------------	---------------	---------------

## VR-B256

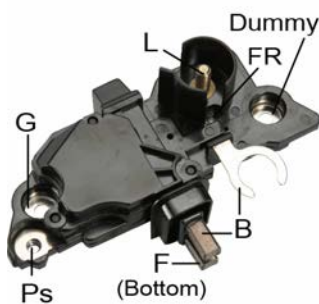

- \*A-Circuit
- \*For 14mm OD slip ring
- \*Soft Start
- \*2.5 sec. LRC
- \*Short Circuit Protection
- \*Voltage Set Point:14.5V

### Replaces

#### BOSCH :

F-00M-145-220	F-00M-145-349
---------------	---------------

### Unit no.

#### BOSCH

0-124-215-001	0-124-215-002	0-124-215-003	0-124-215-005	0-124-225-016	0-124-225-026
0-124-225-027	0-124-325-009	0-124-325-028	0-124-415-011	0-124-415-012	

**VR-B257**

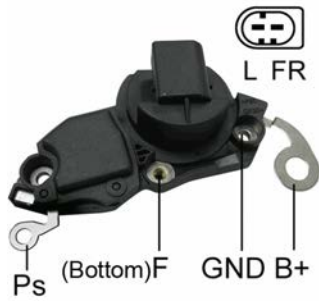

- \*A-Circuit
- \*Soft Start
- \*2.5 Second LRC
- \*Short Circuit Protected
- \*Voltage Set Point:14.3V

**Replaces**

**BOSCH :**  
 01229AA0X0      F00M225401      F00M225201      F00M225200

**Unit no.**

**BOSCH**  
 0-122-0AA-0B0    0-122-0AA-2A0    0-122-500-076    0-986-041-760

**VR-B259**



- \*A-Circuit
- \*Soft Start
- \*2.5 sec. LRC
- \*Short Circuit Protection
- \*Voltage Set Point:14.6V

**Replaces**

**BOSCH :**  
 F-00M-145-224    F-00M-145-241

**Unit no.**

**BOSCH**  
 6004MA5008      6004ML0017      6004ML0024  
**GM**  
 10418888

**VR-B260**

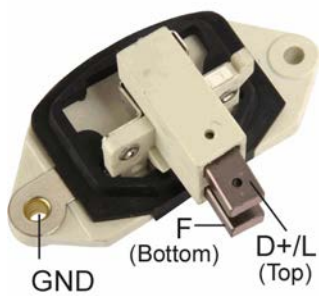

- \*A-Circuit
- \*For 32mm OD slip ring
- \*Voltage Set Point:14.2V

**Replaces**

**BOSCH :**  
 1197311032      1197311033      1197311045      1197311046      2197311032

**Unit no.**

**BOSCH**  
 0-120-484-011    0-120-488-134    0-120-488-138    0-120-488-205    0-120-488-233

**VR-B260B**

\*A-Circuit  
\*28V

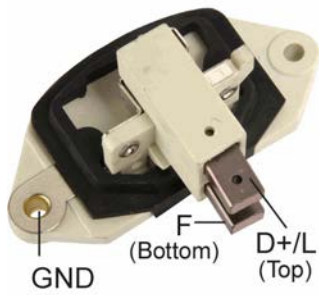

**Replaces**

**BOSCH :**

1-197-311-310    1-197-311-313    1-197-311-314    2-197-311-310

**Unit no.**

**BOSCH**

0-120-488-206    0-120-488-234    0-120-488-283    0-120-488-294    0-120-488-298    9-120-060-039  
9-120-080-144

**VR-B261**

\*A-Circuit  
\*Voltage Set Point: 14.4V

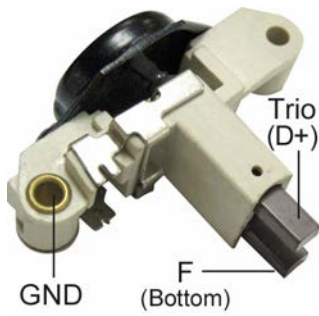

**Replaces**

**BOSCH :**

1-197-311-541

**Unit no.**

**BOSCH**

0-123-320-040    0123320046    0123320047    0123320049    0123320051    0123320058  
0123320060    0123320061    0123320062    0123340007



## VR-B262

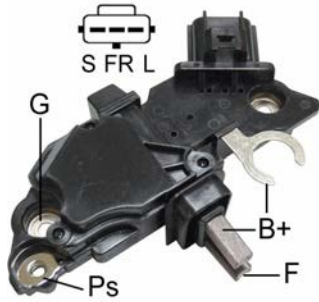

- \*A-Circuit
- \*Active Lamp
- \*Soft Start
- \*8.5 sec. LRC
- \*Short Circuit Protection
- \*Voltage Set Point: 14.5V

### Replaces

#### BOSCH :

F-00M-145-255    F-00M-A45-210    F-00M-145-361

### Unit no.

#### BOSCH

0-124-315-019    0-124-315-027    0-124-415-016    0-124-415-030    0-124-415-032    0-124-525-021  
 0-124-325-100    0-124-415-029    0-124-415-031

### Used On

#### FORD

Transit Diesel                      2.0 DI 2000 up  
 Transit Diesel                      2.4 DI/TDE/TDCi  
 Transit Diesel                      2.4 DI/TDE/TDCi/TDdi  
 Transit Diesel                      2.0 TDCi 2000 up

## VR-B263

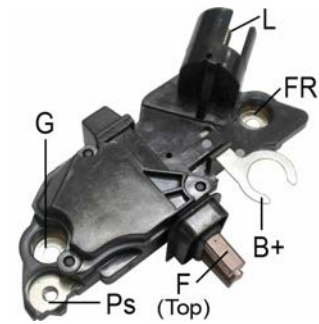

- \*B-Circuit
- \*Soft Start
- \*2.5 Second LRC
- \*Short Circuit Protected
- \*Voltage Set Point: 14.4V

### Replaces

#### BOSCH :

F-00M-145-252

### Unit no.

#### BOSCH

0-124-615-002    0-124-615-027

## VR-B264

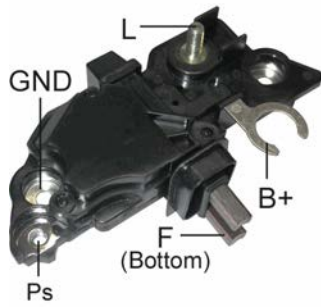

- \*A-Circuit
- \*Active Lamp
- \*Soft Start
- \*2.5 sec. LRC
- \*Short Circuit Protection
- \*Voltage Set Point:14.4V

### Replaces

#### BOSCH :

0-031-542-906    F-00M-145-248    F-00M-145-358

#### MERCEDES-BENZ :

0031542806    0031545506    0031545606

### Unit no.

#### BOSCH

0-124-325-039	0-124-325-046	0-124-325-093	0-124-325-105	0-124-515-061	0-124-515-064
0-124-515-091	0-124-515-114	0-124-515-118	0-124-525-085	0-124-615-015	0-124-615-019
0-124-615-033	0-124-615-035	0-124-625-020			

#### CHRYSLER

5134199AA    5134204AA    5134205AA

#### MERCEDES-BENZ

0121541502	0121542002	0121542402	0121544602	0131541302	0131541502
0131541702					

### Used On

#### DODGE

Freightliner

#### MERCEDES-BENZ

Sprinter Vans

## VR-B265

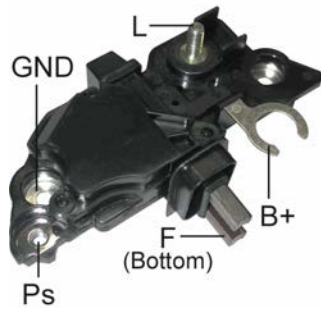

- \*A-Circuit
- \*Soft Start
- \*2.5 sec LRC
- \*Short Circuit Protection
- \*Voltage Set Point:14.7V

### Replaces

#### BOSCH :

F-00M-145-227

### Unit no.

#### BOSCH

0-124-515-008    0-124-515-043

#### GM

21019217    22674550    9227893

**VR-B266**

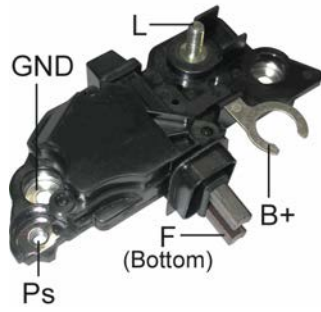

- \*A-Circuit
- \*Soft Start
- \*0.5 Second LRC
- \*Short Circuit Protected
- \*Voltage Set Point:14.4V

**Replaces**

**BOSCH :**

F-00M-145-271    F-00M-145-366

**Unit no.**

BOSCH

0-124-525-016

**VR-B267**

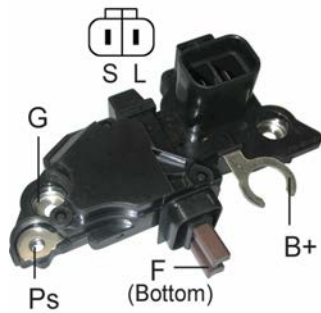

- \*A-Circuit
- \*Soft Start
- \*5 Second LRC
- \*Short Circuit Protected
- \*Voltage Set Point:14.5V

**Replaces**

**BOSCH :**

F-00M-145-207    F-00M-145-347    F-00M-A45-228

**Unit no.**

BOSCH

0-124-325-008    0-124-325-010    0-124-515-041

## VR-B268



- \*B-Circuit
- \*Soft Start
- \*0.5 Second LRC
- \*Short Circuit Protected
- \*Loss of Sense Lamp On
- \*Voltage Set Point:28.3V

### Replaces

#### BOSCH :

F-00M-144-103    F-00M-144-119    F-00M-145-246    F-00M-145-297

#### Unit no.

#### BOSCH

0-124-555-005	0-124-555-009	0-124-555-010	0-124-555-017	0-124-555-020	0-124-555-030
0-124-655-005	0-124-655-006	0-124-655-008	0-124-655-012	0-124-655-013	0-124-655-019
0-124-655-030	0-124-655-033	0-120-000-019	0-124-555-006	0-124-555-028	0-124-555-077
0-124-555-084	0-124-655-082				

#### CASE

87715948

#### DAF

1450808                      1624197                      1794477                      1806492

#### IVECO

42537055                      42540208                      42560643

#### KHD

01182475

#### MERCEDES-BENZ

0001542405

#### RENAULT

7420523391

#### VOLVO

20523391

## VR-B269



- \*A-Circuit
- \*Voltage Set Point:14.5V

### Replaces

#### BOSCH :

F002G10376079

**VR-B270**



- \*B-Circuit
- \*Soft Start
- \*2.5 Second LRC
- \*Short Circuit Protected
- \*Voltage Set Point:14.4V

**Replaces**

**BOSCH :**  
 F00M145286      F00M145394      F00MA45233

**Unit no.**

BOSCH  
 0-124-525-035

**VR-B271**



- \*A-Circuit
- \*0.5 Second LRC
- \*Soft Start 18%
- \*Voltage Set Point:14.4V

**Replaces**

**AUDI/VW :**  
 038903803F

**BOSCH :**

F-00M-A45-209	F-00M-144-154	F-00M-145-195	F-00M-145-200	F-00M-145-223	F-00M-145-233
F-00M-145-234	F-00M-145-315	F-00M-145-333	F-00M-145-344	F-00M-145-354	F-00M-145-383
F-00M-145-891	F-00M-A45-208	F-00M-A45-303	F-00M-144-128	0-124-525-216	F-00M-145-237
F-00M-145-238	F-00M-145-354	F-00M-145-355			

**Unit no.**

BOSCH  
 0-124-325-019      0-124-515-028

## VR-B280



- \*A-Circuit
- \*BSS Connections
- \*Requires COM01 test adaptor for testing

### Replaces

#### BMW :

12317515319

#### BOSCH :

F-00M-A45-219    F-00M-145-678    F-00M-145-278    F-00M-A45-218    F-00M-145-280    F-00M-145-679

### Unit no.

BOSCH

0-124-525-026    0-124-515-105    0-124-525-080

### Used On

#### BMW

325 Series 2.5L	2004-
X3 2.5L	2004-
525i 2.5L	2004-
Z4 2.5L	2003-
Z4 3.0L	2003-

## VR-B285



- \*A-Circuit
- \*COM
- \*Voltage Set Point: 14.3V
- \*Requires COM01 test adaptor for testing

### Replaces

#### BOSCH :

F-00M-145-285

### Unit no.

BOSCH

0-124-515-045    0-124-525-042

**VR-B295**

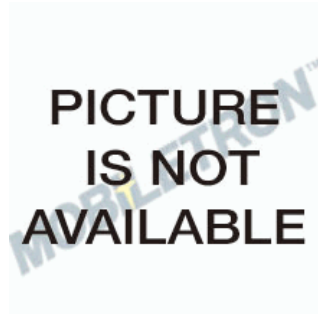

**Replaces**

**BOSCH :**

F-00M-145-295    F-00M-145-375

**Unit no.**

BOSCH

0-124-525-049    0-124-525-135    0-124-525-084    0-124-525-141

**Used On**

**RENAULT**

Laguna 2000 16V

2001-2007

Leguna 2000 16V Turbo

2002-2007

**VR-B296**



- \*B-Circuit
- \*Soft Start
- \*2.5 Second LRC
- \*Short Circuit Protected
- \*Voltage Set Point:14.6V

**Replaces**

**BOSCH :**

F-00M-145-261    F-00M-145-296    F-00M-145-341    F-00M-145-396    F-00M-145-397    F-00M-145-862  
 F-00M-145-876

**VOLKSWAGEN :**

06F903803    06F903803A    06F903803AX    070903803B    070903803E    078903803E

**Unit no.**

BOSCH

0-124-215-008	0-124-325-044	0-124-325-076	0-124-325-081	0-124-325-083	0-124-325-095
0-124-325-096	0-124-325-097	0-124-325-125	0-124-325-138	0-124-325-140	0-124-515-040
0-124-515-059	0-124-515-068	0-124-525-008	0-124-525-010	0-124-525-050	0-124-525-067
0-124-525-087	0-124-525-089	0-124-525-092	0-124-525-095	0-124-615-009	0-124-615-021
0-124-615-031	0-124-615-038	0-124-625-010	0-124-625-018	0-124-625-028	0-124-215-009
0-124-315-031	0-124-315-032	0-124-325-061	0-124-325-066	0-124-325-067	0-124-325-073
0-124-325-088	0-124-325-131	0-124-515-103	0-124-515-117	0-124-515-122	0-124-515-125
0-124-525-090	0-124-615-007	0-124-325-132	0-124-315-036	0 124 515 028	

**VR-B300**

PICTURE  
IS NOT  
AVAILABLE

**Replaces****BOSCH :**

F-00M-A45-300    F-00M-144-175    F-00M-145-891    F-00M-145-315

**Unit no.****BOSCH**

0-124-315-037	0-124-325-126	0-124-325-127	0-124-325-128	0-124-325-129	0-124-325-130
0-124-325-141	0-124-325-142	0-124-325-160	0-124-525-062	0-124-525-066	0-124-525-074
0-124-525-088	0-124-525-091				

**VR-B3102**

PICTURE  
IS NOT  
AVAILABLE

**Replaces****BOSCH :**

0-272-223-102

**Unit no.****BOSCH**

0-126-312-006



## VR-B314



- \*B-Circuit
- \*Voltage Set Point: 13.8V
- \*Soft Start
- \*2.5 sec. LRC
- \*Short Circuit Protection
- \*Regulated Voltage Control(RVC)
- \*Requires VR-RVC01 test adaptor for testing

### Replaces

#### BOSCH :

F-00M-145-314    F-00M-145-328    F-00M-145-696

### Unit no.

#### BOSCH

0-124-425-032	0-124-425-049	0-124-425-063	0-124-425-064	0-124-525-072	0-124-525-104
0-124-425-007	0-124-425-008	0-124-425-030	0-124-425-031		

#### GM

10335497	10366269	15233597
----------	----------	----------

### Used On

#### CADILLAC

Escalade 8 Cyl. 5.3L 2005-

#### CHEVROLET

Avalanche 8 Cyl. 5.3L	2005-
Silverado 6 Cyl. 4.3L	2005-2006
Silverado 8 Cyl. 4.8L	2005-2007
Silverado 8 Cyl. 5.3L	2005-
Silverado 8 Cyl. 6.0L	2005-2007
Suburban 8 Cyl. 5.3L	2005-
Suburban 8 Cyl. 6.0	2006-
Tahoe 8 Cyl. 4.8L	2005-2006
Tahoe 8 Cyl. 5.3L	2006-

#### GMC

Sierra 6 Cyl. 4.3L	2005-2007
Sierra 8 Cyl. 4.8L	2005-2007
Sierra 8 Cyl. 5.3L	2005-
Yukon 8 Cyl. 4.8L	2005-2006
Yukon Denali 8 Cyl. 6.0L	2005-2006
Yukon XL 8 Cyl. 5.3L	2005-
Yukon XL 8 Cyl. 6.0L	2005-2006

## VR-B322



### Unit no.

#### BOSCH

0-124-525-063

## VR-B330

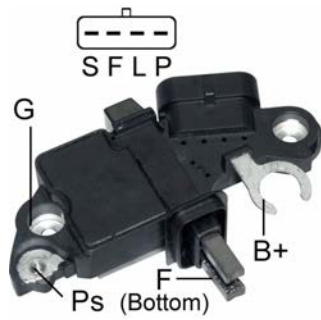

- \*B-Circuit
- \* Soft Start
- \* 2.5 sec. LRC
- \* Short Circuit Protection
- \* Voltage Set Point: 14.7V

### Replaces

**BOSCH :**  
F-00M-145-330

### Unit no.

BOSCH  
0-124-325-134

## VR-B360



- \*A-Circuit
- \*Soft Start
- \*10 sec. LRC
- \*Short Circuit Protection
- \*Voltage Set Point: 14.5V

### Replaces

**BOSCH :**  
F00M145251      F00M145254      F00M145360      F00MA45236

### Unit no.

BOSCH  
0-124-515-050

## VR-B363

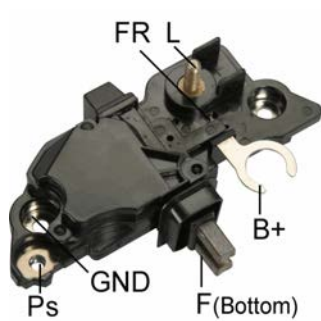

- \* A-Circuit
- \* Active Lamp
- \* Soft Start
- \* 5.0 sec. LRC
- \* Short Circuit Protection
- \* Self-Exciting
- \* Voltage Set Point:14.3V

### Replaces

**BOSCH :**  
F-00M-144-140    F-00M-145-260    F-00M-145-363    F-00M-145-249    F-00M-145-325    F-00M-A45-231

**MERCEDES-BENZ :**  
0031545606      0031542906      0031549106

### Unit no.

BOSCH  
0-124-325-046    0-124-325-105    0-124-515-061    0-124-515-091    0-124-515-118    0-124-525-085  
0-124-525-109    0-124-615-015    0-124-615-035  
MERCEDES-BENZ  
0111547402      0121541702      0121542202      0131543202      0131543402      0131543602

**VR-B369**

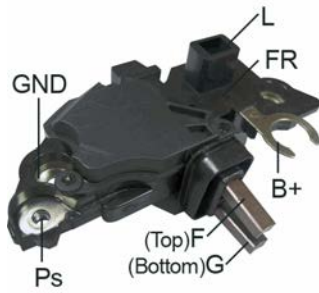

- \*B-Circuit
- \*Soft Start
- \*5 sec. LRC
- \*Short Circuit Protection
- \*Voltage Set Point: 14.6V

**Replaces**

**BOSCH :**

F00M145369      F00M145208      F00M145229      F00M145279      F00M145351      F00MA45211

**Unit no.**

**BOSCH**

0-124-625-001      0-124-625-003

**VOLVO**

8602713              8602714              8637849              8651665              8676499

**VR-B371**

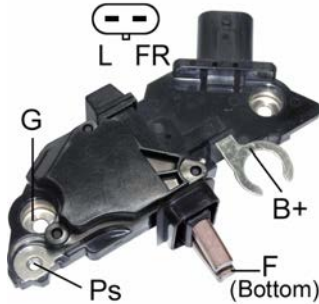

- \*A-Circuit
- \*Soft Start
- \*10 Second LRC
- \*Short Circuit Protected
- \*Voltage Set Point: 14.5V

**Replaces**

**BOSCH :**

F00M145228      F00M145283      F00M145364      F00M145371      F00M144668      F00M144171  
 F00M145265

**GM :**

93173428              93176049

**Unit no.**

**BOSCH**

0-124-415-009      0-124-415-025      0-124-425-004      0-124-425-019      0-124-425-048      0-124-515-032  
 0-124-515-033      0-124-515-095      0-124-515-096      0-124-525-031

**VR-B372**

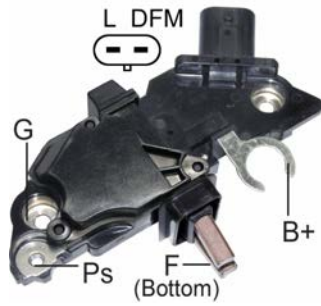

- \*A-Circuit
- \*Soft Start
- \*2.5 Second LRC
- \*Short Circuit Protection
- \*Voltage Set Point: 14.5V

**Replaces**

**BOSCH :**

F-00M-145-226

**OPEL :**

12793278

**Unit no.**

BOSCH

0-124-425-031

0-124-425-033

0-124-425-040

0-124-425-056

0-124-515-016

0-124-525-058

0-124-525-086

0-124-525-097

**VR-B378**



- \*B-Circuit
- \*Voltage Set Point: 14.1V
- \*LIN-1
- \*19200 Baud Rate (4 Byte)
- \*Requires COM01 test adaptor for testing

**Replaces**

**BOSCH :**

F-00M-145-378

**Unit no.**

BOSCH

0-124-625-023

CHRYSLER

68011841AA

68011841AB

MERCEDES-BENZ

272-154-01-02

A272-154-01-02

**Used On**

**DODGE**

Van Sprinter 2500 V6 3.5L

2007-2008

Sprinter 3500 V6 3.5L

2007-2008

**MERCEDES-BENZ**

R350 V6 3.5L

2006-

## VR-B379

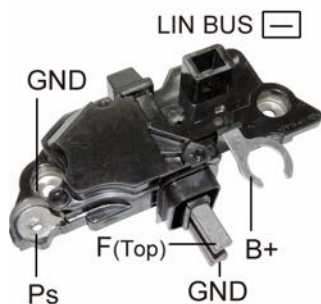

- \*B-Circuit
- \*Voltage Set Point: 13.8V
- \* LIN-1
- \* 9600 Baud Rate (4 Byte)
- \*Requires COM01 test adaptor for testing

### Replaces

#### BOSCH :

F-00M-145-311    F-00M-145-379    F-00M-A45-212

#### Unit no.

#### BOSCH

0-986-047-380    0-124-625-024    0-986-047-500    0-124-625-025    0-986-047-510    0-124-525-061

#### VOLVO

30658084    30667892    8603263    30658086    30667893    8603264

## VR-B385

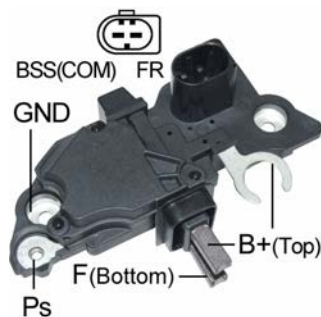

- \*A-Circuit
- \*BSS Connections
- \*Requires COM01 test adaptor for testing

### Replaces

#### BOSCH :

0-031-543-706    0-031-545-806    F-00M-145-293    F-00M-145-385    F-00M-145-272    F-00M-145-367  
 F-00M-144-147

#### Unit no.

#### BOSCH

0-124-615-028

## VR-B391



- \*A-Circuit
- \*For 28mm OD slip ring
- \*Voltage Set Point:14.4V

### Replaces

**BOSCH :**  
 9-190-067-016    9-190-067-017    9-190-067-019    9-190-067-020

**FORD :**  
 E9JY-10316A

**MOTORCRAFT :**  
 GRE802

### Unit no.

**BOSCH**  
 9-120-060-009    9-120-060-020

**FORD**  
 89JA-10300AA    E9JY-10346A

## VR-B392



- \*A-Circuit
- \*For 28mm OD slip ring
- \*Soft Start
- \*short Circuit Protection
- \*Voltage Set Point:14.2V

### Replaces

**BOSCH :**  
 9190067018

### Unit no.

**BOSCH**  
 9-120-060-023

## VR-B393



- \*A-Circuit
- \*For 28mm OD slip ring
- \*Voltage Set Point:14.4V

### Replaces

**BOSCH :**  
 9-191-067-043

### Unit no.

**BOSCH**  
 9-120-061-100

## VR-B394



- \*A-Circuit
- \*Soft Start
- \*10 Second LRC
- \*Short Circuit Protected
- \*Voltage Set Point:14.5V

### Replaces

**BOSCH :**  
 F00M255200    F00M255201    F00M255202    F00M225200

### Unit no.

BOSCH  
 0-122-468-015

## VR-B396

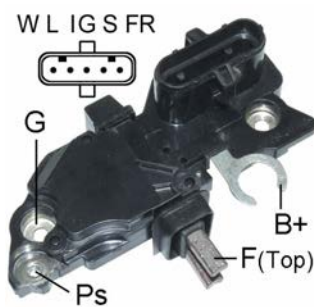

- \*B-Circuit
- \*Soft Start
- \*0.5 sec. LRC
- \*Short Circuit Protection
- \*Loss of Sense Lamp Off
- \*Voltage Set Point:28.3V

### Replaces

**BOSCH :**  
 F-00M-145-302    F-00M-145-307    F-00M-144-107    F-00M-144-123    F-00M-145-256    F-00M-145-298

**DAF :**  
 1600348

**MERCEDES-BENZ :**  
 1542405    1542406    1542605    1542705

**SCANIA :**  
 1501245    1501246    1502245

**VOLKSWAGEN :**  
 2TB903803A

### Unit no.

BOSCH  
 0-124-355-001    0-124-355-002    0-124-555-001    0-124-555-002    0-124-555-007    0-124-555-004  
 0-124-555-012    0-124-555-023    0-124-555-032    0-124-555-044    0-124-555-008    0-124-555-011  
 0-124-555-015    0-124-555-016    0-124-555-021    0-124-555-022    0-124-555-025    0-124-555-042  
 0-124-555-045    0-124-555-046    0-124-655-001    0-124-655-002    0-124-655-004    0-124-655-007  
 0-124-655-016    0-124-655-023    0-124-655-038    0-124-655-042

MERCEDES-BENZ  
 0001542605    0001542705    0031542606

SCANIA  
 1501245    1502245

VOLKSWAGEN  
 2TB903803A

## VR-B414

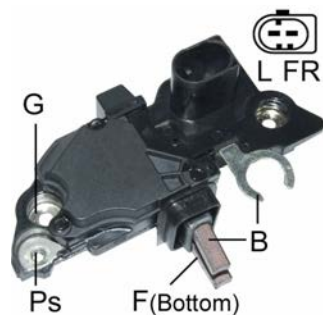

- \*A-Circuit
- \*Active Lamp
- \*Soft Start
- \*2.5 sec. LRC
- \*Short Circuit Protection
- \*Voltage Set Point:14.3V

### Replaces

#### BOSCH :

F-00M-144-143    F-00M-145-287    F-00M-145-372

#### MERCEDES-BENZ :

31546006

### Unit no.

BOSCH

0-124-325-077    0-124-615-025    0-124-625-006    0-124-515-012    0-124-615-046

### Used On

#### MERCEDES-BENZ

Sprinter 2.2L

2003-2010

## VR-B4197



- \* B-Circuit
- \* LIN-1
- \* 19200 Baud Rate

### Replaces

#### BOSCH :

F-00M-144-197    F00M 144 151

### Unit no.

BOSCH

0-124-525-200    0-124-525-113



## VR-B510



- \*A-Circuit
- \*Active Lamp
- \*Voltage Set Point:14.4V

### Replaces

**BOSCH :**

1-197-311-510

### Unit no.

BOSCH

0-123-325-002    0-123-325-012    0-123-325-014

TOYOTA

27060-02100

### Used On

**TOYOTA**

Avensis

1997-2000

Carena E Saloon(T19)

1997-

Carena E(T19)

1997-

## VR-B5204



- \*A-Circuit
- \*BSS Connections

### Replaces

**BOSCH :**

F-00M-255-204

### Unit no.

BMW

12-31-7-507-741    12-31-7-507-995

BOSCH

0-122-0AA-090

### Used On

**BMW**

745i V8 4.4L

2002-2004

745Li V8 4.4L

2002-2004

**VR-B543B**



\*B-Circuit  
\*Voltage Set Point: 28.4V

**Replaces**

**BOSCH :**  
1197311543      123500520

**IVECO :**  
42532975

**Unit no.**

BOSCH  
0-123-525-500      0-123-525-502

**VR-B558B**

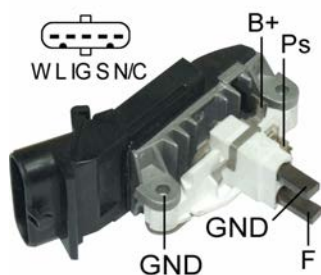

\*B-Circuit  
\*L Terminal Drive Choke  
\*Soft Start  
\*Short Circuit Protection  
\*Voltage Set Point:25.6V

**Replaces**

**BOSCH :**  
1-197-311-558

**MAN :**  
81256010025

**Unit no.**

BOSCH  
0-123-325-500      0-123-525-501

**VR-B657**

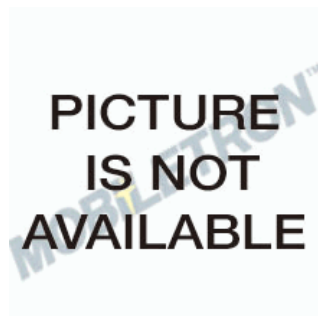

**Replaces**

**BOSCH :**  
F-00M-145-881

**Unit no.**

BOSCH  
0-124-525-083

**VR-B703**

PICTURE  
IS NOT  
AVAILABLE

**Replaces****BOSCH :**

0-272-220-703

**Unit no.**

BOSCH

F-000-BL0-740

FIAT

51905540

**Used On****DACIA**

Dokker 1.5 DCI

2012-

**VR-B704****Replaces****BOSCH :**

0-272-220-704

**Unit no.**

BOSCH

F-000-BL0-633

**VR-B854**

\*LIN

PICTURE  
IS NOT  
AVAILABLE

**Replaces****BOSCH :**

0-272-220-854

**Unit no.**

BOSCH

F-000-BL0-805    0-4E9-030-23J

**VR-B861**



- \*B-Circuit
- \*Soft Start
- \*Short Circuit Protection
- \*Voltage Set Point: 14.5V

**Replaces**

**BOSCH :**  
F-00M-145-340    F-00M-145-861

**Unit no.**

**BOSCH**  
0-124-625-007    0-124-515-055    0-124-515-131    0-124-615-012    0-124-615-044    0-124-615-047  
0-124-515-047    0-124-325-040    0-124-325-045

**Used On**

**MERCEDES-BENZ**

C180 2.0L    2000-2001  
ML500 5.0L    2003-2006

**VR-B880**



- \*B-Circuit
- \*COM
- \*Voltage Set Point: 14.3V
- \*Requires COM01 test adaptor for testing

**Replaces**

**BOSCH :**  
F-00M-145-880    F-00M-145-262    F-00M-A45-221    F-00M-145-312

**Unit no.**

**BMW**  
12317521384    12317521490    12317521491    12317532965    12317532966    12317532969  
12317533270  
**BOSCH**  
0-124-525-045    0-124-525-059    0-124-515-051    0-124-515-098    0-124-525-042    0-124-525-048

**Used On**

**BMW**

116 Z4 Series    2004-  
316Ci 1.6L    2002-2004  
318 Ci 2.0L    2001-  
318i 2.0L    2004-  
316ti 1.8L    2001-2004

**VR-B883**



- \*A-Circuit
- \*Soft Start
- \*5.0 sec. LRC
- \*Short Circuit Protection
- \*Voltage Set Point: 14.0V

**Replaces**

**BOSCH :**

F-00M-145-266    F-00M-145-365    F-00M-145-883

**MERCEDES-BENZ :**

0031545706

**Unit no.**

BOSCH

0-124-625-019    0-124-525-161    0-124-625-002    0-124-625-004

**VR-B885**



- \*B-Circuit
- \*Voltage Set Point: 14.2V
- \*LIN-1 Connections
- \*19200 Baud Rate (4 Byte)
- \*Requires COM01 test adaptor for testing

**Replaces**

**BOSCH :**

F-00M-144-157    F-00M-145-309    F-00M-145-377    F-00M-145-885

**MERCEDES-BENZ :**

0031546106

**Unit no.**

BOSCH

0-124-525-054    0-124-525-055    0-124-525-195    0-399-604-015

MERCEDES

0141543702    2721540002    6361540102    A0141543702    A2721540002    A6361540102

**Used On**

**MERCEDES-BENZ**

C230	2005-2009
CLK280 V6	2005-2010
C350 V6	2007-2012
C280 V6 3.0L	2006-2007
SLK350 V6	2004-2010
SLK280 V6	2004-2010
CLK350 V6	2005-2010
C300 V6 3.0L	2010-
C350 V6 3.5L	2006-2009
E350 V6 3.5L	2006-2009

**VR-C524**

\*Electronic type  
\*Voltage Set Point:14.5V



**Replaces**

<b>CHRYSLER :</b>					
1889960	2095700	2098300	3000074	CH524	

**Unit no.**

<b>CHRYSLER</b>					
2095000	2095060	2095100	2095300	2095425	2095661
3438171					

**VR-C545**

\*Voltage Set Point:14.7V

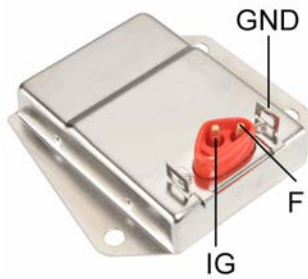

**Replaces**

<b>CHRYSLER :</b>					
3438150	3755850	3755960	3874520		

**Unit no.**

<b>CHRYSLER</b>					
3237797	3438846	3438847	3656570	3755585	4091727

**VR-C545H**

\*Heavy Duty  
\*Voltage Set Point: 14.7V

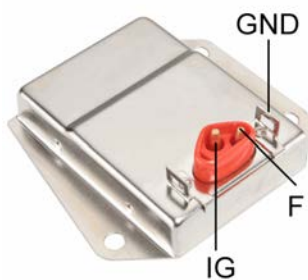

**Replaces**

<b>CHRYSLER :</b>					
3438150	3755850	3755960	3874520	3755970	4003708
4091050	4111990	4144187	5234625	CH537	CH543
CH544	CH545				

**Unit no.**

<b>CHRYSLER</b>					
3237797	3438846	3438847	3656570	3755585	4091727

**VR-D271**

\*Voltage Set Point:14.6V

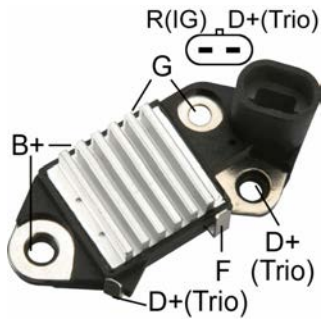

**Replaces**

**DAEWOO :**

271910                      93740796

**Unit no.**

DAEWOO

219170                      96380673

**VR-D276**

\*Voltage Set Point:14.7V



**Replaces**

**DAEWOO :**

276010

**DELCO :**

276010

**Unit no.**

DAEWOO

96303556

**VR-K03**

\*Voltage Set Point: 14.4V

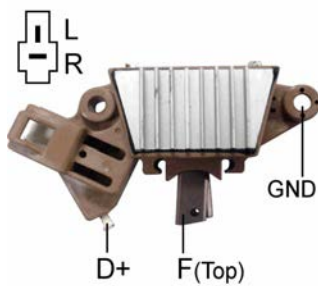

**Unit no.**

DAEWOO

31410-A80D00

**VR-K04**

\*Voltage Set Point: 14.6V

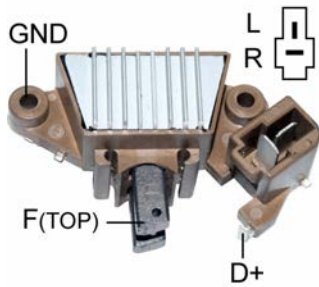

**Replaces**

DAEWOO :  
DAD25006D

**Unit no.**

DAEWOO  
31400-A78B02    31400-A78-130

**Used On**

DAEWOO

Tico 0.8

1995-2000

**VR-K06B**

\* 24V  
\* Has an internal diode  
\* Voltage Set Point: 28.8V

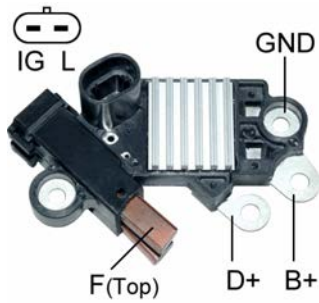

**Unit no.**

DELCO  
A124041    A134153    390104



**VR-D001B**

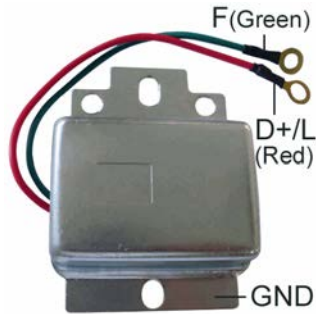

\*24V  
\*Voltage Set Point:28.2V

**Replaces**

**CATERPILLAR :**

2P1699

**PRESTOLITE :**

8-393	8-394	83-93	83-94	VSH-6401C	VSH-6401CS
VSH-6401D	8393	8-394	VSH-6401ES		

**Unit no.**

PRESTOLITE

ANB7001	ANB7002	ANB7003	ANB7004
---------	---------	---------	---------

**VR-D100**



\*Voltage Set Point:14.3V

**Replaces**

**DELCO :**

94652566

**VR-D1033**

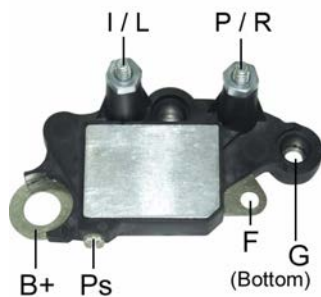

\*Self Exciting  
\*Short Circuit Protection  
\*Voltage Set Point: 14.2V

**Replaces**

**DELCO :**

10521033

**Unit no.**

DELCO	
8600310	8600889

**VR-D186**

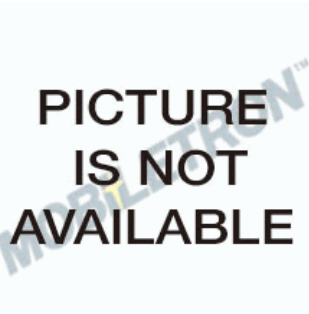

Unit no.   
 DELCO   
 13579662      13500186

**VR-D231**



- \*Soft Start
- \*8.5 sec. LRC w/open sense indication
- \*Short Circuit Protection
- \*Voltage Set Point:14.8V

**Replaces**

DELCO :   
 10458198      10453673      10483777      10483778

Unit no.

DELCO   
 10464408      10464421      10464430      10464439      10464492      10480411   
 25744164      25744165

**VR-D232**

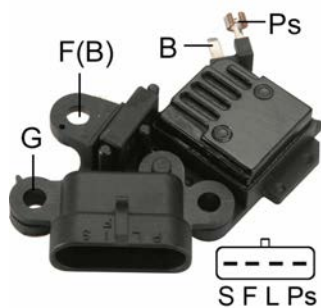

- \*Soft Start
- \*2.5 sec. LRC
- \*Short Circuit Protection
- \*Voltage Set Point:14.8V

Unit no.

DELCO   
 10464406      10480327      10480341      3211750

**VR-D233**

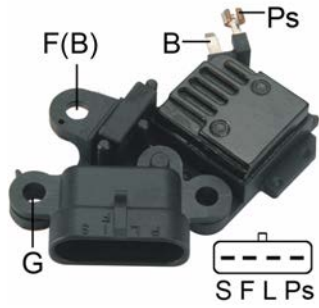

\*Voltage Set Point:14.8V  
 \*2.5 sec. LRC w/open sense indication

**Replaces**

**DELCO :**  
 10458202            15063025            15163024

**Unit no.**

DELCO  
 10464459            10464460            10464483            10464484            15056100            15087020  
 15087021

**VR-D234**



\*Voltage Set Point:14.8V  
 \*8.5 sec. LRC

**Replaces**

**DELCO :**  
 10484046

**Unit no.**

DELCO  
 10480368            10480428

**VR-D235**

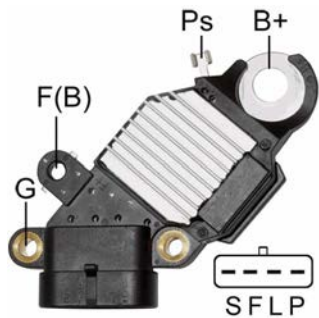

\*S-F-L-P Terminals  
 \*B-Circuit  
 \*Inactive Lamp  
 \*Soft Start  
 \*2.5 sec. LRC  
 \*Short Circuit Protection  
 \*Lamp off when S Open  
 \*Voltage Set Point:14.8

**Replaces**

**DELCO :**  
 19060319            19060345

**Unit no.**

DELCO  
 10464476            15226003            15754097            15754097A            15754097M            15754097W

**VR-D235SE**

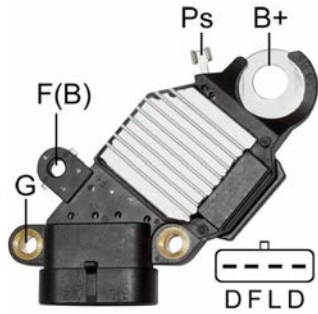

- \*With Self-Exciting
- \*B-Circuit
- \*Voltage Set Point: 14.6V

**Replaces**

**DELCO :**

10483643      10486311      19053013      19053730      19054622      19060319

**VR-D238**

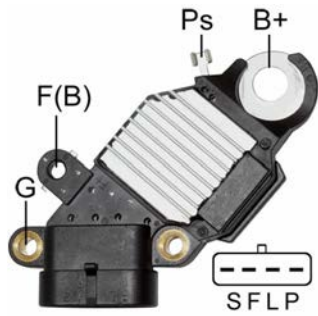

- \*B-Circuit
- \*Inactive Lamp
- \*Soft Start
- \*8.5 sec. LRC
- \*Short Circuit Protection
- \*S Open Lamp On
- \*S-F-L-P Terminals
- \*Voltage Set Point: 14.8V

**Replaces**

**DELCO :**

10453673      10458198      10483777      10483778

**VR-D282**

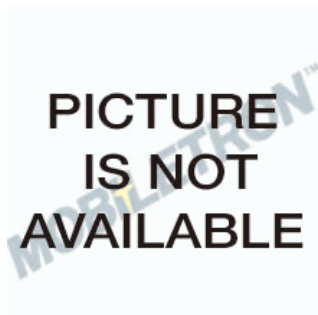

**Replaces**

**DELCO :**

10527282

Unit no.

DELCO

8600201

**VR-D406B**

- \*Voltage Set Point: 27.9V

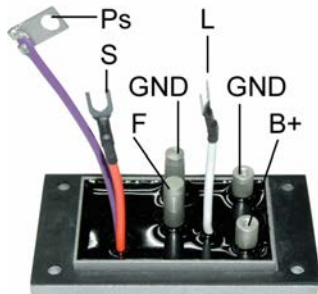

**Replaces**

**DELCO :**

19020406

**VR-D412**

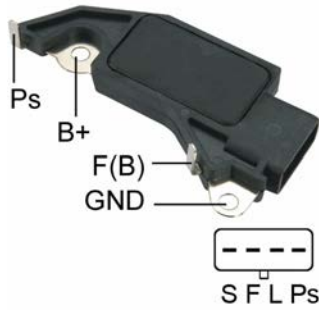

- \*P-L-F-S Terminals
- \*Soft Start
- \*8.5 sec LRC
- \*Short Circuit Protection
- \*Voltage Set Point:14.6V

**Replaces**

**DELCO :**

1116412                      19009712

**VR-D424**



- \*L Terminal Drives Choke
- \*Soft Start
- \*Voltage Set Point:14.7V

**Replaces**

**DELCO :**

1116424

**Unit no.**

DELCO  
1101199                      1101551

**VR-D432**

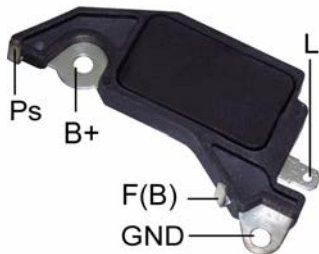

- \*L Terminal Drives Choke
- \*Soft Start
- \*Voltage Set Point:14.7V

**Replaces**

**DELCO :**

1116432

**Unit no.**

DELCO  
1101816

**VR-D440**



- \*L Terminal Drives Choke
- \*Soft Start
- \*Voltage Set Point:14.7V

**Replaces**

**DELCO :**  
1116440

**Unit no.**

TOYOTA  
27060-02050      27060-74200

**VR-D445**



- \*B-Circuit
- \*Inactive Lamp
- \*Soft Start
- \*8.5 sec. LRC
- \*Short Circuit Protection
- \*S-F-L-PS Terminals
- \*With Instrument Cluster Gauges
- \*Voltage Set Point:14.6V

**Replaces**

**DELCO :**  
1116445

**Unit no.**

DELCO  
10480055      10480227      10480265      10480278      10480296      10480297  
10480311

**VR-D481**

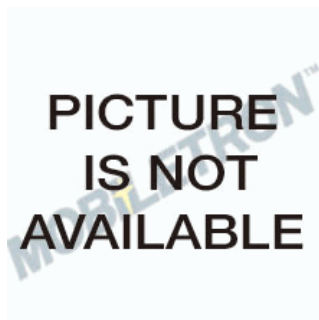

**Replaces**

**DELCO :**  
10459481      10459482      10459483      10459596      15095471      15098392  
15100053      15178637      15183649      15183650      15183651      15188853  
15188854      19020378      19020384      19020385      19020393      19020394  
19020810      19020811      19020812      19020813      19020816      19020817  
19020818

**GENERAL MOTORS :**

19116396

**VR-D502**

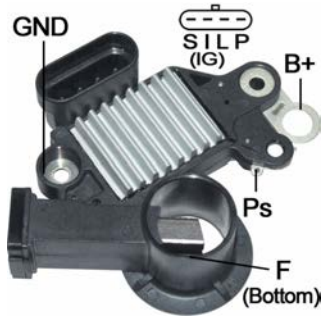

- \*Soft Start
- \*2.5 sec. LRC
- \*Short Circuit Protection
- \*Voltage Set Point: 14.5V

**Replaces**

**DELCO :**  
220116

**SSANGYONG :**  
66215-43006

**Unit no.**

SSANGYONG  
66215-45102      66215-45502

**Used On**

**DAEWOO**

New Musso

**SSANGYONG**

Rexton

**VR-D579H**



- \*Soft Start
- \*2.5 sec. LRC
- \*Short Circuit Protection
- \*S Open Lamp Off
- \*Voltage Set Point: 14.6V

**Replaces**

**DELCO :**  
10503579

**Unit no.**

DELCO  
15200109      15845337      15845338      15847291

**VR-D583**



- \*Soft Start
- \*2.5 sec. LRC
- \*Short Circuit Protection
- \*Voltage Set Point: 13.8V
- \*Regulated Voltage Control(RVC)
- \*Requires RVC01 tester box for testing

**Unit no.**

DELCO  
13500582      13579663      13500577      13579666      13579668      13502595  
13579661      13579667

**VR-D602H**

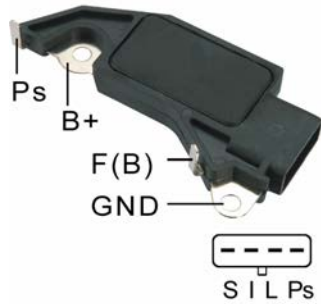

- \*B-Circuit
- \*Inactive Lamp
- \*Soft Start
- \*8.5 sec. LRC
- \*Short Circuit Protection
- \*S-I-L-Ps Terminals
- \*Voltage Set Point:14.6V

**Replaces**

**DELCO :**  
1116446                      D602A

**Unit no.**

DELCO  
10480135                      10480171                      CS144

**VR-D635**



- \*Electronic Type
- \*Voltage Set Point:14.5V

**Replaces**

**DELCO :**  
1119506                      1119512                      1119515                      1119519                      D635                      D663

**Unit no.**

DELCO					
1100553	1100557	1100558	1100566	1100567	1100568
1100569	1100570	1100571	1100572	1100590	1100591
1100600	1100601	1100605	1100613	1100615	1100616
1100619	1100654	1100688	1100693	1100694	1100699
1100721	1100722	1100821	1100834	1100836	1100837
1100838	1100839	1100841	1100842	1100843	1100845
1100846	1100847	1100849	1100856	1100860	1100870
1100871	1100875	1100878	1100879	1100886	1100888
1100889	1102434	1102435	1102437	1102439	1102440
1102455	1102943	1102944	1102945	321161	321164
321169	321182				

**VR-D668B**

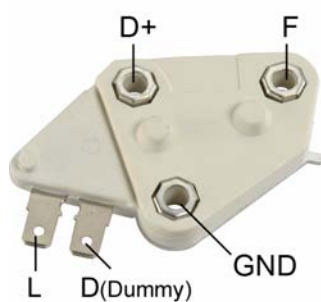

- \*24V
- \*For use on One wire hook-up,
- \*low cut-in,Agricultural,
- \*Industrial and Marine Application
- \*Voltage Set Point:28.0V

**Replaces**

**DELCO :**  
234060



**VR-D668C**

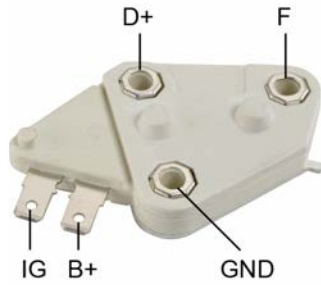

\*VR-D668CL (Volts setting 14.2V)  
 \*For use on Delco 10, 12&15SI Alternators  
 \*Voltage Set Point:14.7V

**Replaces**

**AMC :**

8125176

**BOSCH :**

0-986-192-000

**DELCO :**

233738	1116392	D668	D680	1116380	1116384
1116385	1116387	1116387H	1116423	13472406	16003652
3472406	7896932	DR600	DR666	DR667	DR668

DR680

**LUCAS :**

21226042      UCB701

**MOTORCRAFT :**

GR307

**OPEL :**

1204236

**Unit no.**

DELCO					
10456313	10479850	10479925	10497083	1100109	1100110
1100111	1100113	1100115	1100116	1100117	1100119
1100120	1100121	1100124	1100125	1100127	1100128
1100129	1100130	1100131	1100132	1100133	1100134
1100135					

**VR-D669C**

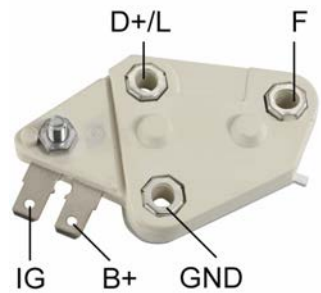

\*For use on Delco 10SI type 116, 20SI, 27SI type 200  
 \*For use on Delco 30 & 40SI  
 \*Voltage Set Point:14.2V

**Replaces**

**DELCO :**

1116360	1116389	1116390	13001740	1876388	9343233
---------	---------	---------	----------	---------	---------

DR669

**MOTORCRAFT :**

GR536

**Unit no.**

DELCO					
10459017	10459036	1117160	1117163	1117880	1117885
1117886	1117887	1117890	1117891	1117919	

**VR-D670C**

\*For use on Opel, Triumph, Vauxhall  
 \*Voltage Set Point:14.7V

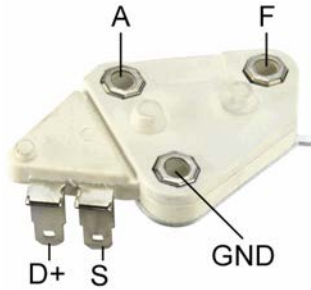

**Replaces**

<b>DELCO :</b>		
7934605	7934614	7982866
<b>LUCAS :</b>		
21226041	UCB700	
<b>OPEL :</b>		
1204245		

**VR-D671C**

\*For use on:  
 \*Austin,Princess,Commer,Leyland,MG,MGB8,Vauxhall,Opel  
 \*Voltage Set Point:14.7V

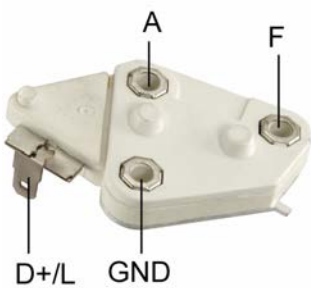

**Replaces**

<b>DELCO :</b>	
21226043	7982685
<b>LUCAS :</b>	
UCB702	
<b>MAGNETI MARELLI :</b>	
940038033	

**VR-D672C**

\*24V  
 \*For use on Delco 20SI Type 200, 29SI & 30SI  
 \*Voltage Set Point:27.5V

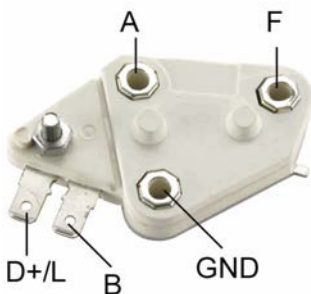

**Replaces**

<b>CATERPILLAR :</b>				
3T6353	3T6354	6N1874	7N7799	9N1207
<b>DELCO :</b>				
1105510	1116388	1984287		

**Unit no.**

<b>DELCO</b>					
10SITYPE116	1103123	1105475	1987518	20SI	27SITYP200
29SI	30SI	321648	321651	321654	

**VR-D673C**

\*For use on Opel, Vauxhall  
 \*Voltage Set Point:14.7V

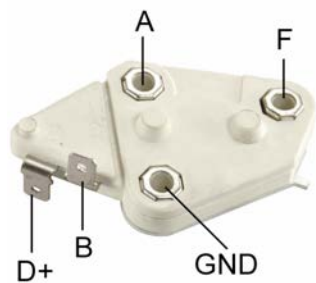

**Replaces**

**BOSCH :**

0-986-192-015

**DELCO :**

13472557                      3472557                      3493050

**DELCO REMY (LUCAS) :**

21226104

**GM :**

3474557

**LUCAS :**

UCB703

**MAGNETI MARELLI :**

940038032

**OPEL :**

1204248

**VALEO(DUCELLIER) :**

592983

**Unit no.**

**DELCO**

3472020	3472021	3472023	3472028	3472032	3472033
3472037	3472038	3472042	3472048	3472049	3472050
3472051	3472052	3472053	3472057	3472058	3472059
3472060	3472061	3472062	3472063	3472064	3472065
3472066	3472067	3472068	3472069	3472070	3472072
3472073	3472074	3472075	3472082	3472091	

**VR-D674**

\*VR-D674 For 5A. Field  
 \*For use on OPEL, VAUXHALL  
 \*Voltage Set Point:14.8V

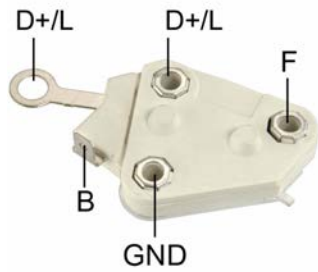

**Replaces**

<b>DELCO :</b>					
3493029	3493030	3493079	3493080		
<b>LUCAS :</b>					
UCB705					
<b>OPEL :</b>					
1204257	1204258	1204263	1204264		
<b>VALEO :</b>					
A564796A					

**Unit no.**

<b>DELCO</b>					
3472104	3472105	3472106	3472119	3472120	3472121
3472128	3472130	3472134	3472135	3472136	3472137
3472139	3472142	3472143	3472144	3493604	3493606
3493619	3493621	3493634	3493635	3493639	3493641
3493644	3493704	3493706			

**VR-D674H**

\*For 8A. Field  
 \*For use on OPEL, VAUXHALL  
 \*Voltage Set Point:14.8V

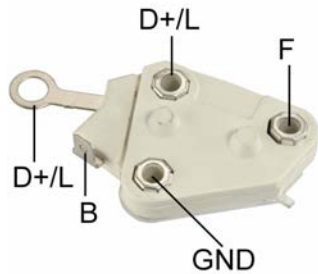

**Replaces**

<b>DELCO :</b>					
3293030	3493029	3493079	3493080		
<b>LUCAS :</b>					
UCB705					
<b>OPEL :</b>					
1204257	1204258	1204263	1204264		

**Unit no.**

<b>DELCO</b>					
3472104	3472105	3472106	3472119	3472120	3472121
3472128	3472130	3472134	3472135	3472136	3472139
3472142	3472143	3472144	3493604	3493606	3493619
3493621	3493634	3493635	3493639	3493641	3493644
3493704	3493706	3742106			

**VR-D675H**

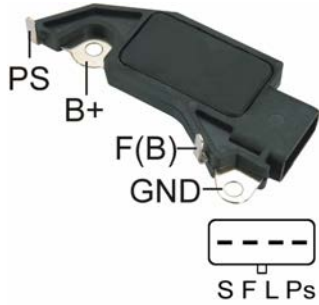

- \*B-Circuit
- \*Inactive Lamp
- \*Soft Start
- \*2.5 sec. LRC
- \*Short Circuit Protection
- \*S-F-L-Ps Terminals
- \*Voltage Set Point:14.6V

**Replaces**

<b>DELCO :</b>				
1116408	1116428	D675	D699	

**Unit no.**

DELCO	
CS130	CS144

**VR-D676**

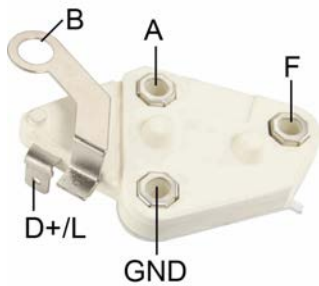

- \*For use on OPEL, VAUXHALL
- \*Voltage Set Point:14.7V

**Replaces**

<b>DELCO :</b>	
9315303	9345333
<b>LUCAS :</b>	
UCB704	
<b>VALEO(DUCELLIER) :</b>	
592984	

**VR-D677**

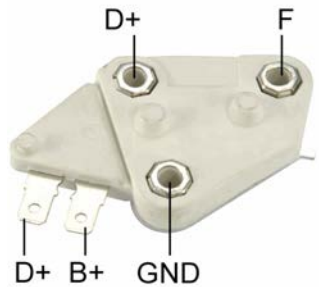

- \*Voltage Set Point:14.7V

**Replaces**

<b>DELCO :</b>	
1988988	D674

**Unit no.**

DELCO					
10479930	10497082	1101134	1101215	1101224	1101236
1101252	1101258	1101280	1101290	1101308	1101324
1101328	1105366	1105402	1105442	1105445	1105448
1105480	1105481	1105491	1105492	1105499	1105505
1105515	1105543	1105558	1105571	1105581	1105585
1105595	1105596	1105606	1105618	1105623	1105627
1105628	1105629	1105630	1105632	1105633	1105648
1105655	1105656	1105658	1105680	1105683	1105690
1105696	1105700	321267	321269	321648	

**VR-D678H**



- \*P-L-F-S Terminals
- \*Soft Start
- \*10 Second LRC
- \*Short Circuit Protected
- \*Voltage Set Point:14.2V

**Replaces**

**DELCO :**

D678                      D684

**Unit no.**

DELCO

10480018	10480019	10480120	1101133	1101270	1101295
1101330	1101574	1101591	1101850	3211029	3211071
321368	321485				

**VR-D679SE**

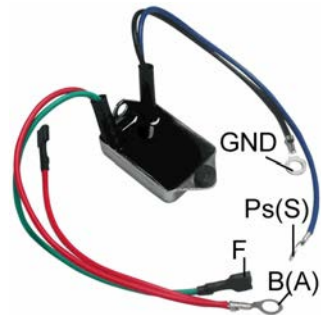

- \*Self Exciting
- \*Voltage Set Point:14.8V

**VR-D680**

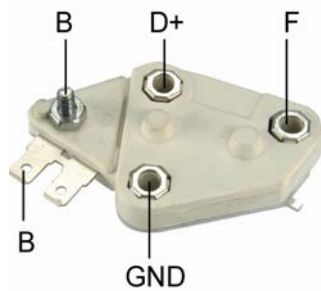

- \*For use on Delco 20SI, 21SI, 26SI
- \*With Webbed Terminals
- \*Voltage Set Point:14.0V

**Replaces**

**DELCO :**

1116433                      1116435                      1116442                      6159599                      D686                      DVR202

**Unit no.**

DELCO

10459017	10459036	1117160	1117163	1117880	1117885
1117886	1117887	1117890	1117891	1117892	1117894
1117895	1117903	1117905	1117906	1117909	1117910
1117913	1117914	1117916	1117917	1117918	1117919
1117925	1117926	1117936			

**VR-D681H**



- \*B-Circuit
- \*Inactive Lamp
- \*Soft Start
- \*8.5 sec. LRC
- \*Short Circuit Protection
- \*S-F-L-Ps Terminals
- \*With Instrument Cluster Gauges
- \*Voltage Set Point:14.6V

**Replaces**

**DELCO :**

1116413	1116430	D600A	D681
---------	---------	-------	------

**Unit no.**

DELCO

10463096	10463108	10463119	10463121	10463122	10463189
10463190	10463201	10463295	10463442	10479995	10480008
10480055	10480116	1101296	1101490	1101518	1101519
1101578	321387	321399	321410	321412	321413
321481	321482	321492	321580	321581	

**VR-D682**

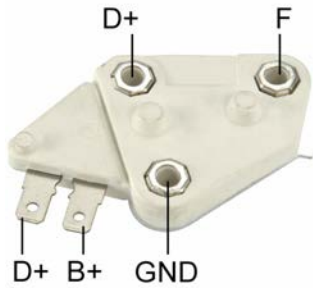

- \*For Use on: Delco 21SI Alternators
- \*Voltage Set Point:14.0V

**Replaces**

**DELCO :**

1116438	1116439	1116441
---------	---------	---------

**Unit no.**

DELCO

1117926	1117936	1117939	1117940
---------	---------	---------	---------

**VR-D683H**



- \*S-I-L-PS Terminals
- \*Soft Start
- \*2.5 Second LRC
- \*Short Circuit Protected
- \*Voltage Set Point:14.2V

**Replaces**

**DELCO :**

1116425	D683
---------	------

**Unit no.**

DELCO

10479852	10479959	10479976	1101482	1101561	1101571
1101605	1101616	1101625	1101806	CS130	CS144

**VR-D686**

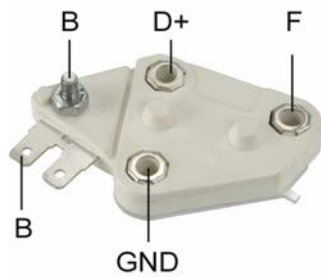

\*For Use On: Delco 10SI, 20SI, 21SI, 26SI,29SI & 30SI  
 \*With Webbed Terminals  
 \*Voltage Set Point:14.2V  
 \*Heavy Duty Version

**Replaces**

**DELCO :**

1116406	1116407	1116435	1894489	D672
---------	---------	---------	---------	------

**Unit no.**

**DELCO**

10459017	10459036	1117160	1117163	1117880	1117885
1117886	1117887	1117890	1117891	1117892	1117894
1117895	1117903	1117905	1117906	1117909	1117910
1117913	1117914	1117916	1117917	1117918	1117919

**VR-D687**

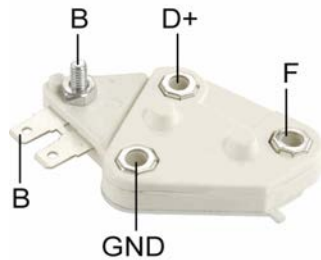

\*24V  
 \*For Use On: Delco 10SI Type 116, 20SI, 27SI Type 200,  
 \*29SI & 30SI  
 \*With Webbed Terminals  
 \*Voltage Set Point:27.5V

**Replaces**

**DELCO :**

1116388	1987518
---------	---------

**Unit no.**

**DELCO**

10SITYPE116	1100077	1100211	1101285	1102916	1102918
1102919	1102934	1103123	1105475	20SI	27SITYPE200
29SI	30SI	321654			

**VR-D689**

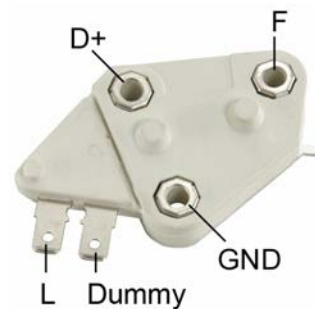

\*Agricultural, Industrial & Marine Applications Self Exciting  
 \*For 12V Systems One Wire Hook-up  
 \*Voltage Set Point:14.7V



**VR-D690**

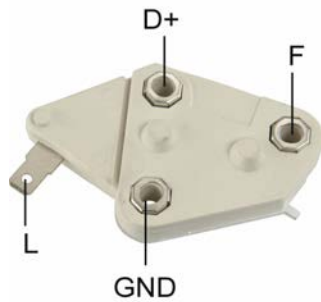

- \*A-Circuit
- \*Inactive Lamp
- \*Voltage Set Point:14.7V

**Replaces**

**CATERPILLAR :**

9L6774

**DELCO :**

D686

D687

D690

94648534

1116433

1116435

1116442

**VR-D691**

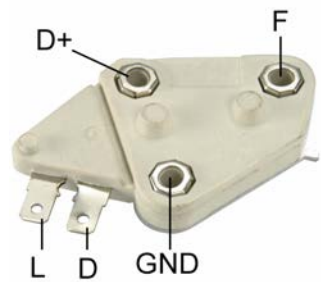

- \*Self Exciting For 6V System
- \*Agricultural, Industrial & Marine Applications
- \*Voltage Set Point:7.8V

**Replaces**

**DELCO :**

234058

**VR-D692**

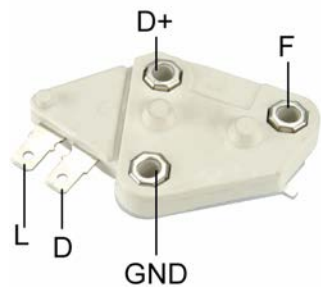

- \*Self Exciting For 8V System
- \*For use on: One wire hook-up,
- \*low cut-in, Agricultural, Industrial and Marine Applications
- \*Voltage Set Point:9.7V

**VR-D694H**



- \*B-Circuit
- \*Inactive Lamp
- \*Soft Start
- \*2.5 sec. LRC
- \*Short Circuit Protection
- \*S-I-L-Ps Terminals
- \*Without Adapter Plug
- \*Voltage Set Point:14.6V

**Replaces**

**DELCO :**

1116429	1116436	1116437	1116439	1116440	D677
D685	D698				

**Unit no.**

DELCO

10479805	10480095	10480096	1101584	1101626	CS121
CS130	CS144				

**VR-D694HD**

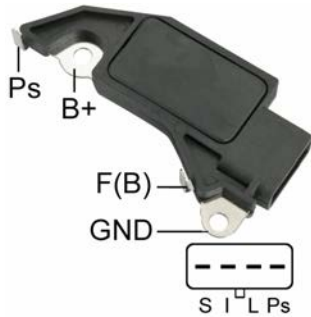

- \*With Ridged Heat Sink
- \*Without adapter plug
- \*Voltage Set Point:14.6V

**Replaces**

**DELCO :**

1116411	1116429	1116436	1116437	1116439	1116440
D677	D685	D698			

**Unit no.**

DELCO

10479805	10480095	10480096	1101584	1101626	
----------	----------	----------	---------	---------	--

**VR-D694SE**

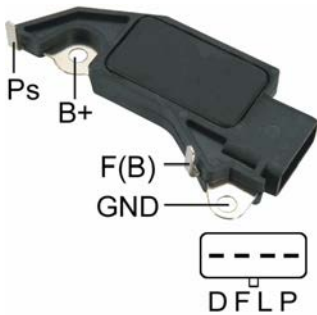

- \*B-Circuit
- \*D-F-L-P Terminals
- \*Self Exciting
- \*Voltage Set Point:14.6V

**Replaces**

**DELCO :**

1116411	1116429	1116436	1116437	1116439	1116440
D677	D685	D698			

**VR-D696B**

\*Voltage Set Point:27.5V

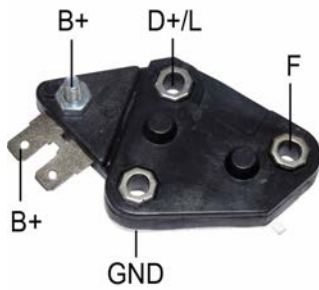

**Replaces**

**DELCO :**

1105510	1116388	1116404	1116405	1894460	1984287
1987518					

**Unit no.**

**DELCO**

102934	11000211	1100077	1100078	1101285	1102916
1102918	1102919	1103123			

**VR-D701**

\*B+ - L Terminals  
\*Voltage Set Point:14.6V

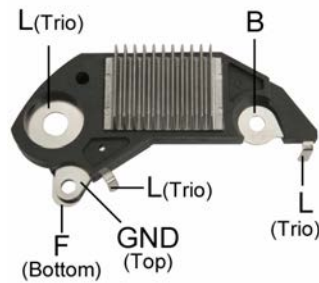

**Replaces**

**DELCO :**

10475019	19009701	19009716
----------	----------	----------

**GM :**

140475019

**MAGNETI MARELLI :**

940038030

**OPEL :**

1204270

**Unit no.**

**DELCO**

10479914	10479923	10479947	10479955	QY6J5
----------	----------	----------	----------	-------

**GM**

3493814	3493823	3493847	3493855
---------	---------	---------	---------

**OPEL**

6204002	6204006	6204007	6204008
---------	---------	---------	---------

**VR-D702H**



- \*B-Circuit
- \*Inactive Lamp
- \*Soft Start
- \*2.5 sec. LRC
- \*Short Circuit Protection
- \*S-I-L-Ps Terminals
- \*Voltage Set Point:14.6V

**Replaces**

**DELCO :**

19009702                    19009719

**Unit no.**

DELCO

10463663	10470119	10479981	10479984	10480017	10480052
10480071	10480072	10480119			

OPEL

3211008	3211023	3211025	3211026	3211027	3211031
3211051					

**VR-D702SE**



- \*B-Circuit
- \*D-F-L-D Terminals
- \*D:Dummy
- \*Self Exciting
- \*Voltage Set Point:14.6V

**VR-D703H**



- \*B-Circuit
- \*Inactive Lamp
- \*Soft Start
- \*8.5 sec. LRC
- \*Short Circuit Protection
- \*S-I-L-Ps Terminals
- \*Voltage Set Point:14.6V

**Replaces**

**DELCO :**

19009703

**Unit no.**

DELCO

10480043	3211048
----------	---------

**VR-D705H**

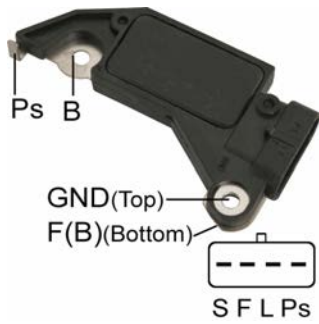

- \*B-Circuit
- \*Inactive Lamp
- \*Soft Start
- \*8.5 sec. LRC
- \*Short Circuit Protection
- \*S-F-L-Ps Terminals
- \*Voltage Set Point: 14.6V

**Replaces**

**DELCO :**  
19009705

**Unit no.**

DELCO  
10480074      10480076      10480079

**VR-D706H**



- \*B-Circuit
- \*Inactive Lamp
- \*P-L-I-S Terminals
- \*Soft Start
- \*2.5 Second LRC
- \*Short Circuit Protected
- \*Voltage Set Point:14.2V

**Replaces**

**DELCO :**  
19009706

**VR-D707**



- \*B-Circuit
- \*Inactive Lamp
- \*Soft Start
- \*2.5 sec. LRC
- \*Short Circuit Protection
- \*P-L-F-S Terminals
- \*Voltage Set Point:14.8V

**Replaces**

**DELCO :**  
19009718      19009748

**Unit no.**

DELCO  
10464413      10464424      10464427      10464437      10464462      10480288  
10480318      10480331      10480336      10480378

**VR-D709**

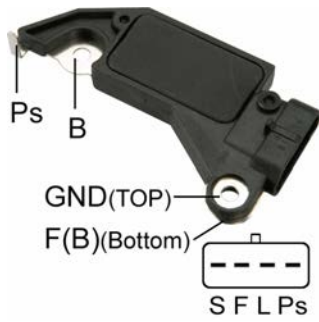

- \*B-Circuit
- \*Inactive Lamp
- \*Soft Start
- \*8.5 sec. LRC
- \*Short Circuit Protection
- \*P-L-F-S Terminals
- \*Voltage set point: 14.8V

**Replaces**

**DELCO :**  
19009729

**Unit no.**

DELCO					
10464415	10464423	10464431	10464432	10480320	10480346
10480361	10480362	3211759			

**VR-D711**

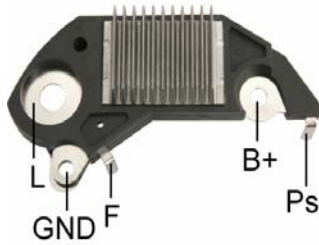

- \*Soft Start
- \*4.0 sec. LRC
- \*Voltage Set Point:14.6V

**Replaces**

**DELCO :**  
19009708      10493240

**GM :**  
10493240

**OPEL :**  
1204288

**Unit no.**

DELCO  
90543910  
OPEL  
6204072

**VR-D712**

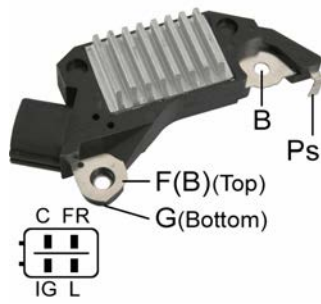

- \*C-FR-IG-L
- \*Soft Start
- \*Short Circuit Protection
- \*For use on Delco CS130D Series IR/IF Alternators
- \*Voltage Set Point:14.8V

**Replaces**

**DELCO :**  
19009715  
**HITACHI :**  
TR1Z-125

**Unit no.**

DELCO  
10480228            10480497  
HONDA  
31100-P8A-A01    31100-P8A-A02

**VR-D713**

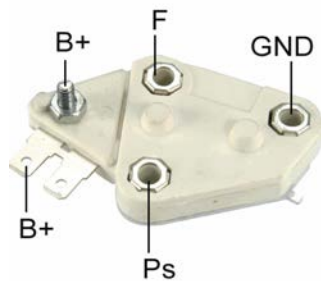

- \*Self-Exciting
- \*Voltage Set Point:14.6V

**VR-D714SE**

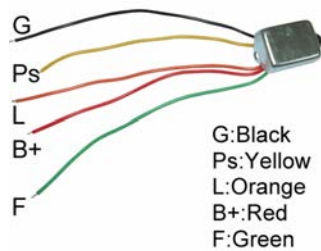

- \*B-Circuit
- \*PS open Lamp on
- \*Voltage Set Point:14.2V

**Replaces**

**DELCO :**  
235864

**VR-D715**



- \*Voltage Set Point: 14.5V
- \*Soft Start
- \*2.5 sec. LRC
- \*Short Circuit Protection

Unit no.  
 DELCO  
 96408588

**Used On**

<b>SUZUKI</b>		
Forenza	2.0L	2004-2007
Reno	2.0L	2005-2007
Swift	1.6L	2004-2005
Verona	2.5L	2004-2006

**VR-D716**



- \*Voltage Set Point: 14.5V

Unit no.  
 GM  
 96954112

**Used On**

<b>SUZUKI</b>		
Forenza 2.0L		2004-2008
Reno 2.0L		2005-2008

**VR-D717**



- \*A-Circuit
- \*I-L Terminals
- \*Inactive Lamp
- \*Soft Start
- \*2.5 sec. LRC
- \*Short Circuit Protection
- \*Voltage Set Point: 14.5V
- \*For use on Korean Delco Alternators

Unit no.  
 GM  
 96540542      96838439  
 SUZUKI  
 31400-85Z00



**VR-D719**



- \*B-Circuit
- \*Inactive Lamp
- \*Soft Start
- \*8.5 sec. LRC
- \*Short Circuit Protection
- \*Voltage Set Point:14.8V

**Replaces**

**DELCO :**  
19009736                    19009751

**Unit no.**

DELCO  
10480280                    10480340

**VR-D720**

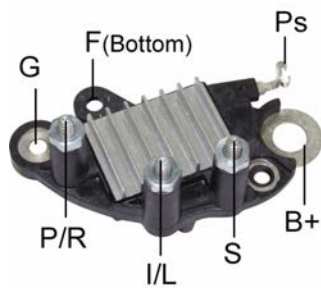

- \*Self Exciting
- \*Short Circuit Protection
- \*Voltage Set Point:14.2V

**Unit no.**

DELCO  
8600307                    8600311                    8600313                    8600314                    8600316

**VR-D737**

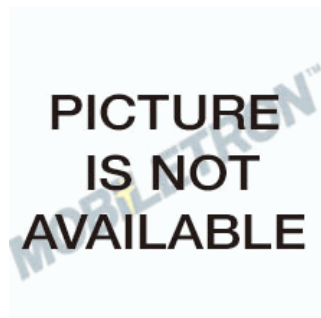

**Replaces**

**GENERAL MOTORS :**  
220737

**Unit no.**

GENERAL MOTORS  
96991181                    1925162

**VR-D740**

\*S-L Terminals  
\*Voltage Set Point:14.6V



**Replaces**

**DELCO :**  
271940

**Unit no.**

DAEWOO  
266000  
DELCO  
19020601      19020612      19020609      19020611

**VR-D744**

\*B-Circuit  
\*Active Lamp  
\*Soft Start  
\*2.5 sec. LRC  
\*Short Circuit Protection  
\*Voltage Set Point:14.4V

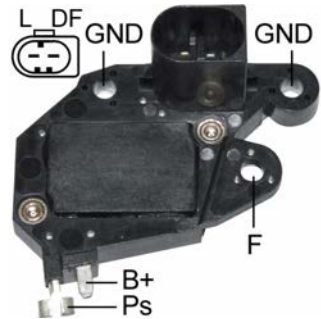

**Replaces**

**DELCO :**  
235542  
**ISKRA :**  
235542

**Unit no.**

DELCO  
10480403  
MERCEDES-BENZ  
0001500850      0001501650      A0001500850      A0001501650

**Used On**

**MERCEDES-BENZ**

C Class C200 CDI	2000-2007
C-Class C220 CDI	2000-2004
C-Class C270 CDI	2001-2005
CLK 270 CDI	2002-2009
E-Class E200 CDI	1999-2002
E-Class Estate E220T	1999-2003
S-Class S320 CDI	1999-2002

**VR-D745**

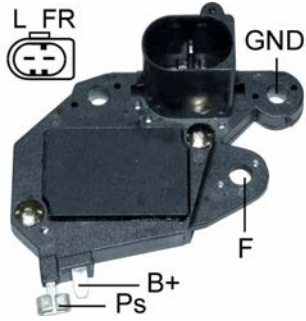

- \*L-FR Terminals
- \*Soft Start
- \*6.0 sec. LRC
- \*Short Circuit Protection
- \*Self Exciting
- \*Voltage Set Point:14.8V

**Replaces**

**DELCO :**  
236563

**MERCEDES-BENZ :**  
A0001501750

**Unit no.**

DELCO

10480407      10480404      10480408

MERCEDES-BENZ

0001502450      A0001502450      0001501750      0001502550      A0001501750      A0001502550

**VR-D747HD**

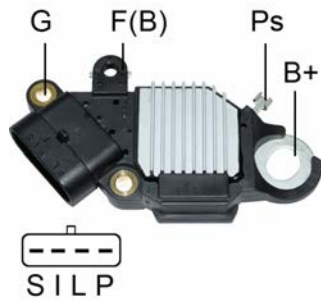

- \*Regitar No.:D747HD
- \*Soft Start
- \*2.5 sec. LRC
- \*Short Circuit Protection
- \*Voltage Set Point: 14.6V

**Replaces**

**DELCO :**  
10494747      10458201

**Unit no.**

DELCO

10480229

**VR-D755**



- \*Voltage Set Point: 13.8V
- \*Soft Start
- \*2.5 sec. LRC
- \*Short Circuit Protection
- \*Regulated Voltage Control(RVC)
- \*Requires RVC01 tester box for testing

**Replaces**

**DELCO :**  
10517755

**Unit no.**

DELCO

10392759      15093928      15200268      15263858      15857608      15905871

**VR-Y002**

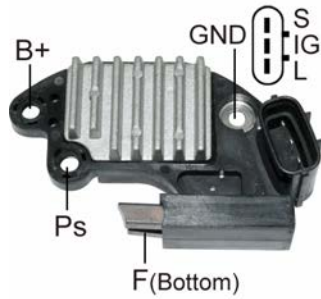

- \*Soft Start
- \*2.5 sec. LRC
- \*Short Circuit Protection
- \*Voltage Set Point: 14.2V

**Replaces**

DELCO :  
JFZ1621-530

**Unit no.**

DELCO  
JFZ1621

**Used On**

**GEELY**

Free Cruiser	1.3L 16V	2005--
Free Cruiser	1.5L 16V	2005--

**VR-Y015**

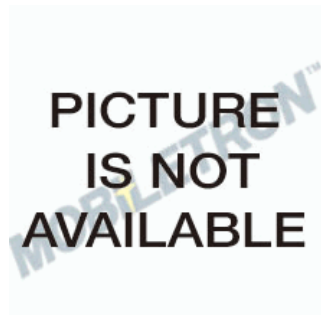



**TB-ND160**

\*Terminal Block

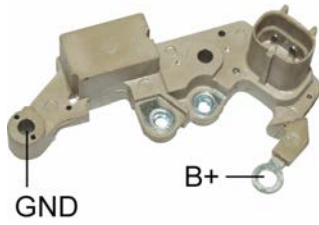

**Replaces**

DENSO :  
126220-0150

**Unit no.**

DENSO					
121000-3620	121000-3630	121000-3670	121000-3671	121000-4231	121000-4232
121000-4233	121000-4250	121000-4251			

**TB-ND163**

\*Terminal Block



**Unit no.**

CHRYSLER			
56029700AD	4896805AD	56029914AD	
DENSO			
421000-0470	421000-0620	421000-0590	421000-0591

**TB-ND165**

\*Terminal Block

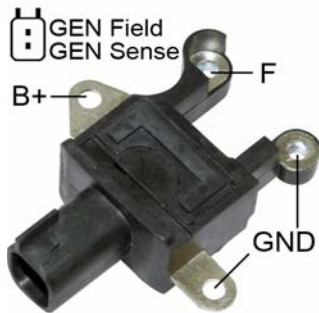

**Unit no.**

CHRYSLER					
4727865AB	4801304AA	4801311AD	4801480AB		
DENSO					
421000-038	421000-041	421000-048	421000-051	421000-052	421000-054
421000-055	421000-056	421000-066	421000-070	421000-0810	

**TB-ND167**

\*Terminal Block

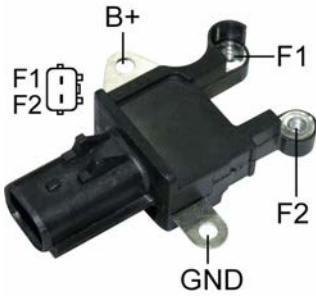

**Replaces**

**DENSO :**  
126220-0230

**Unit no.**

DENSO  
421000-030

**VR-F161**

\*Voltage Set Point:14.4V  
\*Soft Start  
\*2.5 sec. LRC  
\*W/Short Circuit Protection



**Replaces**

**DENSO :**  
126000-7240

**Unit no.**

DENSO					
101210-09710Q	101210-09610Q	101210-09403Q	101210-09400Q	101210-0971	101210-0961
101210-0940					
OPEL					
13256931	13222936	13222929	6204282	6204259	6204256
6204283	13256932	6204258	13222935		

**Used On**

**OPEL**

Corsa 1.3L	
Meriva B 1.3L	
Agila(A)1.0	2003-2007
Astra H 1.4	2004-2004
Astra H Estate 1.4	2004-
Astra H Estate 1.4 LPG	2009-
Astra H Sport Hatch 1.4	2005-
Combo Tour 1.4	2004-
Corsa C 1.0	2003-2009
Corsa C 1.2	2000-2009
Corsa D Van 1.0	2006-
Corsa D Van 1.2	2010-
Corsa D Van 1.3 CDTI	2006-
Corsa D Van 1.3 CDTI	2010-
Meriva 1.4 16V Twinport	2004-2010
Meriva B 1.3 CDTI	2010-

**VR-F163**

PICTURE  
IS NOT  
AVAILABLE

**Replaces**

**DENSO :**

126601-7230

**Unit no.**

DENSO

102211-8622      DAN1033

OPEL

13256929

**VR-F164**

PICTURE  
IS NOT  
AVAILABLE

**Replaces**

**DENSO :**

126000-7320      126600-7320

**Unit no.**

DENSO

101210-0910      DAN1061

TOYOTA

27060-0T010



**VR-H2005-1**



\*A-Circuit  
\*Voltage Set Point:14.4V

**Replaces**

**BOSCH :**

0-986-192-017

**DENSO :**

126000-0030	126000-0060	126000-0100	126000-0101	126000-0120	126000-0140
126000-0141	126000-0310				

**TOYOTA :**

27700-26050	27700-28030	27700-38100	27700-41050	27700-45020	27700-45021
-------------	-------------	-------------	-------------	-------------	-------------

**Unit no.**

**DENSO**

021000-0100	021000-0150	021000-0180	021000-0270	021000-0300	021000-0310
021000-6510	021000-6560	021000-7830	021000-8050	100211-0030	100211-0040
100211-0090	100211-0130	100211-0181	100211-0190	100211-0240	100211-0330
100211-0340	100211-0360				

**TOYOTA**

27020-28010	27020-28020	27020-45140	27060-26010	27060-28012	27060-28020
27060-28040	27060-38021	27060-38032	27060-41010	27060-41011	27060-45020
27060-45030	27060-45031	27060-45032	27060-45050	27060-61011	27060-70020

**VR-H2005-10**

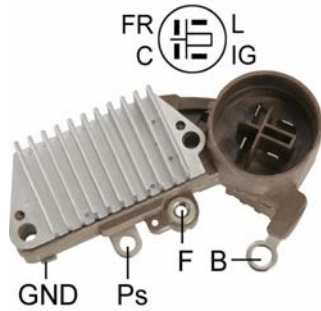

\* 63.5mm Mounting Length  
\* C-FR-IG-L Terminals  
\* L Terminal Drives Choke  
\* W/Capacitor Inside  
\* Repair Circuit: VR-H2005-10S  
\* Voltage Set Point:14.4V

**Replaces**

**DENSO :**

126000-0940	126000-1030	126000-1410	126000-1700	126000-1300	126000-1720
126000-1860	126000-1880				

**HONDA :**

31150-PM4-003

**Unit no.**

**DENSO**

100211-3590	100211-3660	100211-3690	100211-5480	100211-5850	100211-5890
100211-8150	100211-8710	100211-8740			

**HONDA**

31100-P13-0130	31100-P39-0030	31100-PM5-A01	31100-PM8-A01	31100-PM8-A03	31100-PT3-A51
31100-PT3-A52	CHA-50	CJP-75			

**VR-H2005-100**

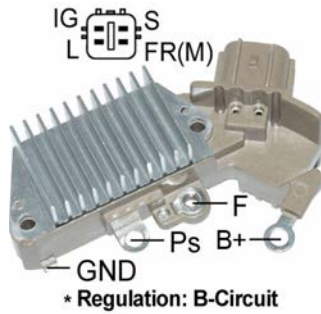

- \*IG-S-L-FR Terminals
- \*Soft Start
- \*6.0 sec. LRC
- \*Short Circuit Protection
- \*W/Capacitor Inside
- \*Voltage Set Point: 14.2V
- \*Regulation: B-Circuit

**Replaces**

<b>DENSO :</b>	
126600-0520	126600-0540
<b>TOYOTA :</b>	
27700-75030	27700-21050

**Unit no.**

DENSO				
104210-8230	104210-8110	104210-8590		
TOYOTA				
27060-75490	27060-75310	27060-75410	27060-75411	27060-75412

**Used On**

<b>TOYOTA</b>	
TACOMA 2.7 4Cyl.	2007-2010

**VR-H2005-101**



- \*Soft Start
- \*2.5 sec. LRC
- \*Voltage Set Point: 14.8V
- \*Regulated Voltage Control(RVC)
- \*Requires RVC01 tester box for testing

**Replaces**

<b>DENSO :</b>
126600-3240

**Unit no.**

DENSO					
104210-3191	104210-3320	104210-4220	104210-4340	104210-4350	104210-4360
104210-4370	104210-4420	104210-4430	104210-6001	104210-6110	104210-6160



**VR-H2005-107**

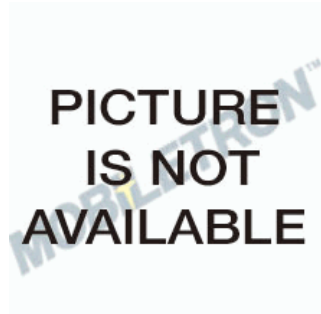

**Replaces**

**TOYOTA :**  
449023R08

**Unit no.**

DENSO  
MA104210-9790  
TOYOTA  
27060- 0M100

**VR-H2005-11**

\* Voltage Set Point:14.4V



**Replaces**

**BOSCH :**  
0-986-192-019

**DENSO :**  
126000-0180      126000-0520      126000-0770      126000-0820

**TOYOTA :**  
27700-57060

**Unit no.**

DENSO  
021000-9660      100211-1720      100211-1721      100211-1730      100211-2750      100213-0080  
100213-0130      100213-0200      100213-0220      100213-0230      100213-0250      100213-0260  
100213-0290      100213-0300      100213-0330      100213-0370      100213-0610      100213-0970  
100213-1160      100213-1290  
HINO  
27050-1170A      27050-1190  
TOYOTA  
27020-64080      27020-64100      27040-54010      27040-54020      27040-54030      27040-54040  
27040-54050      27040-64010      27040-64020      27040-64030      27040-64060

**VR-H2005-12**

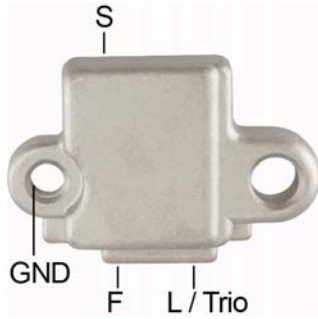

- \*24V
- \*S-G-F Terminals
- \*Voltage Set Point:27.5V

**Replaces**

**DENSO :**  
126000-0200  
**TOYOTA :**  
27700-57050

**Unit no.**

DENSO  
100211-1700      100211-2560      100211-2640

**VR-H2005-140**



- \*Soft Start
- \*2.5 sec. LRC
- \*Short Circuit Protection
- \*Voltage Set Point: 14.4V

**Replaces**

**DENSO :**  
126000-2650

**Unit no.**

DENSO  
101211-7780      102211-1180

**Used On**

**JOHN DEERE**  
6081AFM75 8.1L

2004-2007

**VR-H2005-142**



- \*Voltage Set Point:14.0V
- \*Regulated Voltage Control(RVC)
- \*Requires RVC01 tester box for testing

**Unit no.**

DENSO	104210-3710	104210-3711	104210-3690	YLE500200	YLE500400	YLE500190
	104210-4010	104210-4011	104210-4012	YLE500440	YLE500340	7H42-10300-AC
	LR010513	LR026344	LR027517	DAN989		

**VR-H2005-144**

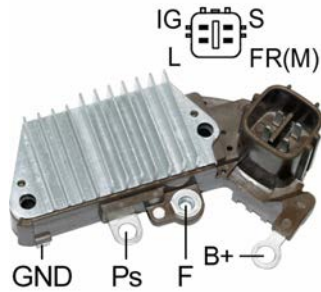

- \* IG-S-L-FR Terminals
- \* 63.5mm Mounting Length
- \* L Terminal Does Not Drive Choke
- \* W/Capacitor Inside
- \* Voltage Set Point:14.2V

**Replaces**

**DENSO :**  
126600-0530

**Unit no.**

TOYOTA  
27060-0L071

**VR-H2005-146**



- \*IG-S-L-FR Terminals
- \*Soft Start
- \*W/O LRC
- \*Short Circuit Protection
- \*Inactive Lamp
- \*Voltage Set Point:14.2V

**Replaces**

**DENSO :**  
126600-3000      236329

**Unit no.**

DENSO  
104210-205      104210-347      104210-420      104210-423      104210-487      104210-4471  
TOYOTA  
27060-0P140      27060-0P020      27060-0P030      27060-31020      27060-31021      27060-31061  
27060-0P141

**VR-H2005-148**

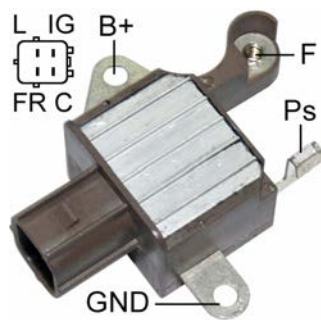

- \* Soft Start
- \* 8.5 sec. LRC
- \* Short Circuit Protection
- \* Voltage Set Point:14.4V

**Replaces**

**DENSO :**  
126600-3660

**Unit no.**

DENSO  
104210-5890  
HONDA  
31100-R40A01

**Used On**

**HONDA**  
Accord 4Cyl. 2.4L

2008-2012

## VR-H2005-149

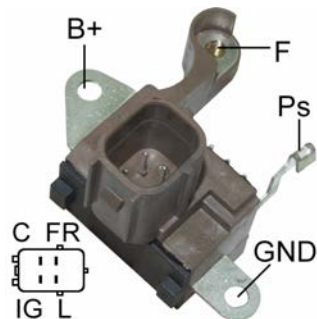

- \*Soft Start
- \*Short Circuit Protection
- \*Voltage Set Point: 14.4V

### Replaces

**DENSO :**  
126600-3650

### Unit no.

DENSO		
104210-5910	104210-5920	104210-1240
HONDA		
31100-RV0-A01	31100-R70-A01	31100-RGW-A01

### Used On

#### HONDA

Accord 3.5L	2008-2010
Odyssey 6Cyl. 3.5L	2008-2013

## VR-H2005-14H



- \* L-IG Terminals
- \* 63.5mm Mfg. Length
- \* L Terminal Drive Choke
- \* W/Capacitor Inside
- \* Repair Circuit: VR-H2005-5S
- \* Voltage Set Point:14.4V

### Replaces

**DENSO :**  
126000-0371

### Unit no.

DENSO	
100211-1402	100211-1452
TOYOTA	
27060-87701	

**VR-H2005-150**

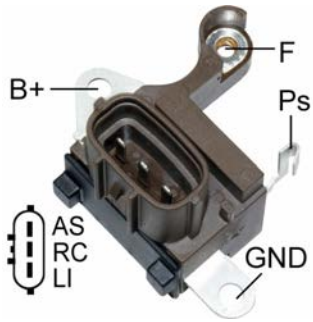

- \*Voltage Set Point: 14.0V
- \*Regulated Voltage Control(RVC)
- \*Requires RVC01 tester box for testing

**Replaces**

**DENSO :**  
126600-3490

**Unit no.**

DENSO  
104210-3691      YLE500390      104210-3601

**VR-H2005-151B**

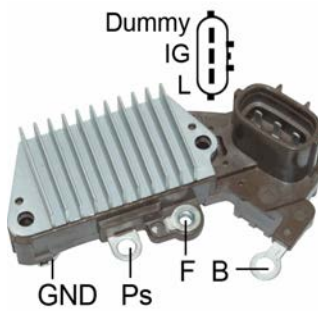

- \* Short Circuit Protection
- \* Voltage Set Point: 28.3V

**Replaces**

**DENSO :**  
126000-3730

**Unit no.**

DENSO  
102211-2820      102211-9060

**VR-H2005-152**



- \*Soft Start
- \*2.5 sec. LRC
- \*Short Circuit Protection
- \*Voltage Set Point: 14.4V

**Replaces**

**DENSO :**  
126600-3080

**Unit no.**

DENSO  
104210-3770  
HONDA  
31100-RDM-A01

**Used On**

**SATURN**  
Vue 3.5L

2004-



**VR-H2005-154**



- \* C-IG-L Terminals
- \* 57.5mm Mounting Length
- \* Soft Start
- \* 8.5 sec. LRC
- \* Short Circuit Protection
- \* Voltage Set Point: 14.4V

**Replaces**

DENSO :  
126000-3450

**VR-H2005-159**

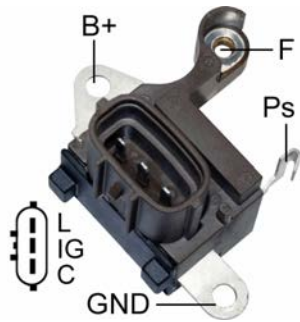

- \*Soft Start
- \*Short Circuit Protection
- \*Voltage Set Point:14.4V

**Unit no.**

DENSO  
104210-4660  
SUZUKI  
31400-67J00

**VR-H2005-15H**

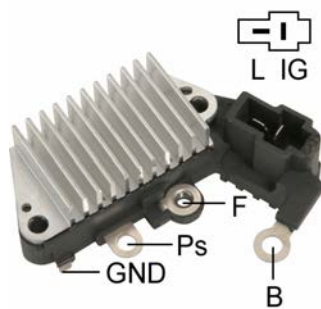

- \* L-IG Terminals
- \* 57.5mm Mounting Length
- \* L Terminal Drives Choke
- \* W/Capactor Inside
- \* Repair Circuit: VR-H2005-15S
- \* Voltage Set Point:14.4V

**Replaces**

DENSO :  
126000-0970      126000-1160

**Unit no.**

DENSO  
100211-4003      100211-4020  
SUBARU  
23700-KA060

**VR-H2005-162B**



- \*24V
- \*P-IG-L Terminals
- \*63.5mm Mounting Length
- \*Voltage Set Point: 28.3V

**Replaces**

**DENSO :**  
126000-2070

**Unit no.**

DENSO  
101211-7920

**VR-H2005-163**



- \*Voltage Set Point: 13.8V
- \*Soft Start
- \*2.5 sec. LRC
- \*Short Circuit Protection
- \*Regulated Voltage Control(RVC)
- \*Requires RVC01 tester box for testing

**Replaces**

**DENSO :**  
126600-3290

**Unit no.**

DENSO  
104210-4560      104210-5070  
GM  
10335498      15826299

**VR-H2005-164A**

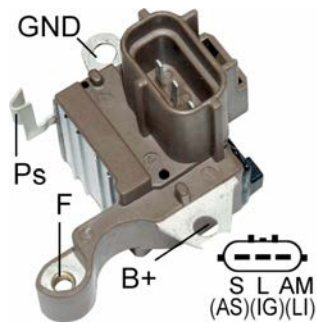

- \*Soft Start
- \*6.0 sec. LRC
- \*Short Circuit Protection
- \*Voltage Set Point: 14.4V

**Replaces**

**DENSO :**  
126600-0110

**Unit no.**

DENSO  
104210-3201      104210-3202      104210-4150      104210-4910  
FORD  
3W4T-10300AG    3W4T-10300AH    3W4Z-10346AA    4W4T-10300AA    4W4Z-10346AA    6W4T-10300AA  
6W4Z-10346AA

**Used On**

**FORD**  
Thunderbird 3.9L      2003-2006

**VR-H2005-165**

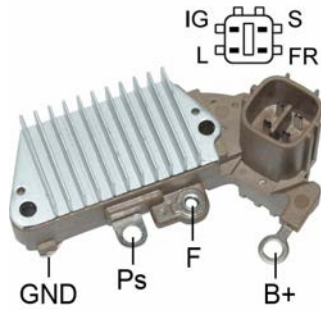

- \*IG-S-L-FR Terminals
- \*Soft Start
- \*8.5 sec. LRC
- \*Short Circuit Protection
- \*Voltage Set Point:13.9V

**Replaces**

**DENSO :**  
126000-2890

**Unit no.**

DENSO  
101211-7892

**Used On**

**JAGUAR**  
S Type 3.0

2000-2004

**VR-H2005-166**

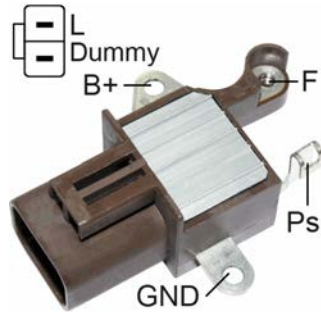

- \* Soft Start
- \* 2.5 sec. LRC
- \* Short Circuit Protection
- \* Voltage Set Point:14.4V

**Replaces**

**DENSO :**  
126600-1890

**Unit no.**

DENSO  
104210-9031  
TOYOTA  
89736-97161

**Used On**

**ISUZU**  
D-MAX 3000

**VR-H2005-16A**



- \* D-IG-L Terminals
- \* 63.5mm Mounting Length
- \* L Terminal Drives Choke
- \* Load Response Control
- \* Soft Start
- \* W/Capacitor Inside
- \* Voltage Set Point: 14.4V

**Replaces**

**DENSO :**  
126000-1200

**ISUZU :**  
8-97032-091-0

**VR-H2005-171**

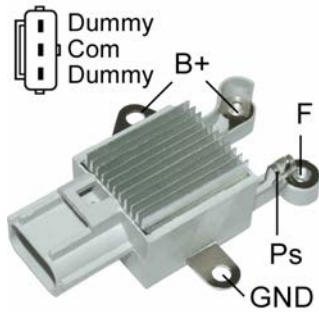

- \*Voltage Set Point: 13.8V
- \*LIN-1 Connections
- \*9600 Baud Rate (3 Byte)
- \*Requires COM01 test adaptor for testing

**Replaces**

**DENSO :**  
126600-7170

**Unit no.**

DENSO				
104210-4640	DAN1059	104210-3550	104210-3560	104210-5740
FORD				
3M5T-10300SD	3M5T-10300SC			
VOLVO				
30659346	30737529	36001463	8603496	30667103

**Used On**

<b>VOLVO</b>			
C70 2.5L			2006-
S40 2.5L			2005-2006
V50 2.4L			2005-2006

**VR-H2005-172**



- \*Soft Start
- \*2.5 sec. LRC
- \*Voltage Set Point:14.4V

**Unit no.**

DENSO					
101211-0530	102211-5020	102211-1430	101211-9340	101211-1860	101211-9880
SUZUKI					
31400-77E11					
TOYOTA					
27060-75040					

**VR-H2005-173**

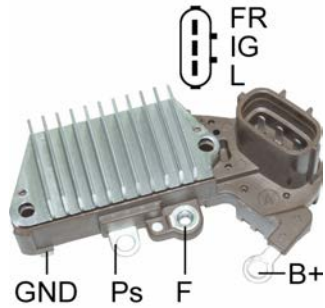

- \*Soft Start
- \*6.5 sec. LRC
- \*Voltage Set Point:14.4V

**Replaces**

**DENSO :**  
126000-3300

**Unit no.**

BMW  
12317515030  
DENSO  
102211-2230      102211-2231      102211-2232      102211-2233

**Used On**

**BMW**  
Mini One 1600 16V      2002-2010  
Mini Cooper 1.6L      2007-2008  
Mini Cooper 1.6L Turbo      2009-

**VR-H2005-176**

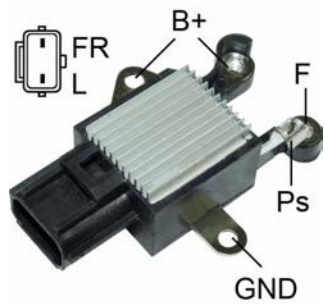

- \* Soft Start
- \* 2.5 sec. LRC
- \* Short Circuit Protection
- \* Voltage Set Point:14.4V

**Unit no.**

DENSO  
104210-4050  
FORD  
3M5T-10300UA  
VOLVO  
30667051A      8602920      86029200

**Used On**

**VOLVO**  
S40 L5 2.4L      2004-  
S40 L5 2.5L      2004-

**VR-H2005-177**

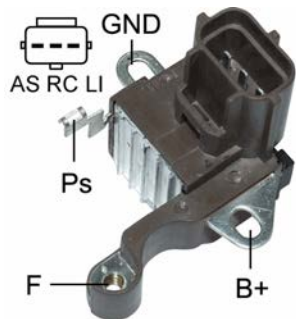

\*Voltage Set Point: 14.0V  
 \*Regulated Voltage Control(RVC)  
 \*Requires RVC01 tester box for testing

**Replaces**

**DENSO :**

126600-4210      126600-3600

**Unit no.**

**DENSO**

104210-2021      104210-5850      104210-6220      104210-5950

**FORD**

9L3T-10300AB      9L2Z-10346A      9R3Z-10346D

**Used On**

**FORD**

Explorer V8 4.6L      2009-2010  
 Explorer Sport Trac V8 4.6L      2009-2010  
 Mustang V8 4.6L      2009-2010

**VR-H2005-178**

\*Requires COM01 test adaptor for testing

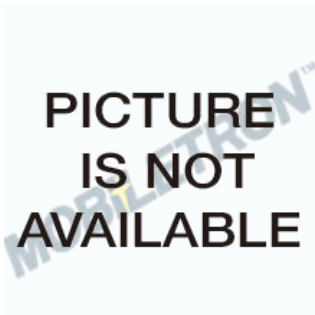

**Replaces**

**DENSO :**

126000-4060      126600-4360

**Unit no.**

**DENSO**

104211-3000      104211-3290      104211-3313      104211-3293

**TOYOTA**

27060-0T260      27060-0N090      27060-36090

**Used On**

**TOYOTA**

Corolla L4 1.8L      2014-  
 RAV4 L4 2.5L      2013-2014

**VR-H2005-179**

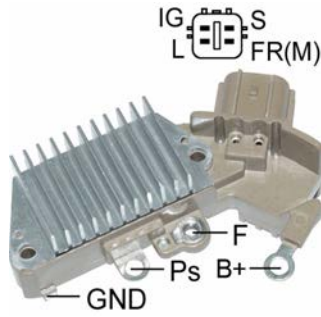

- \*IG-S-L-FR Terminals
- \*Soft Start
- \*8.5 sec. LRC
- \*Short Circuit Protection
- \*Voltage Set Point:14.2V

**Replaces**

**DENSO :**  
126000-3020      126000-3021

**TOYOTA :**  
27700-27070

**Unit no.**

DENSO  
102211-0750      MS102211-8500

TOYOTA  
27060-28070      27060-0D170

**VR-H2005-17A**



- \* S-IG-L Terminals
- \* 63.5mm Mounting Length
- \* L Terminal Drives Choke
- \* Load Response Control
- \* Soft Start
- \* W/Capacitor Inside
- \* Voltage Set Point: 14.4V

**Replaces**

**DENSO :**  
126000-1400

**TOYOTA :**  
27700-70030

**Unit no.**

DENSO					
100211-3050	100211-3240	100211-3391	100211-3500	100211-3520	100211-3680
100211-7130	100211-7140	100211-7440	100211-7450	100211-8030	100211-8050
100211-8070	100211-8090	100211-8350	100211-8640	100211-9700	
TOYOTA					
27060-03010	27060-10011	27060-11020	27060-11030	27060-11060	27060-11220
27060-16131	27060-16230	27060-16260	27060-42030	27060-55011	27060-55030
27060-55050	27060-62040	27060-72062	27060-72071	27060-72150	27060-72171
27060-72180	27060-74080	27060-75050			

**VR-H2005-182**

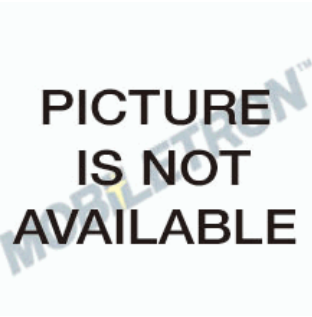

Unit no.   
 DENSO   
 104210-4640      104210-3550

**VR-H2005-183**

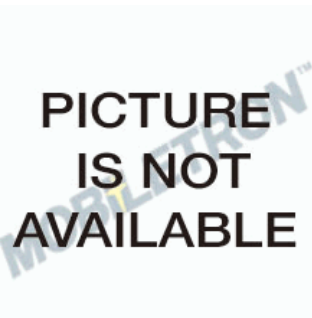

**Replaces**   
 DENSO :   
 7390   
 Unit no.   
 BMW   
 12317591529      12317591530      12317591525      12317591526      12317616119      12317616121   
 DENSO   
 104210-6070      104210-6071      104210-6072      104210-6501

**VR-H2005-184**

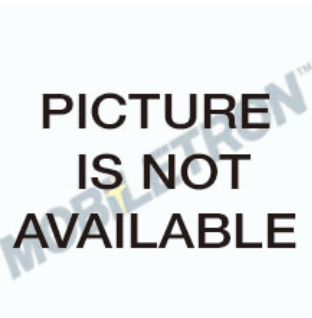

**Replaces**   
 DENSO :   
 104210-6250      7310      7420   
 Unit no.   
 BMW   
 12317591271      12317591268      12317550468      755046801   
 DENSO   
 104210-6040      DAN1040      104210-6021      104210-6254



**VR-H2005-187**



- \*Soft Start
- \*8.0 sec. LRC
- \*Short Circuit Protection
- \*Voltage Set Point: 14.4V

**Replaces**

**DENSO :**  
126000-2931

**Unit no.**

DENSO  
101211-281  
HONDA  
31100-PFC-003

**VR-H2005-189**

\*LIN-1

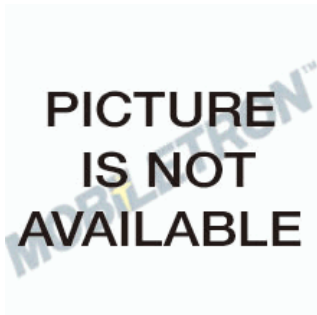

**Unit no.**

DENSO  
104210-6080    104210-1840    04801338AB

**VR-H2005-18A**



- \* S-IG-L Terminals
- \* 63.5mm Mounting Length
- \* L Terminal Does Not Drive Choke
- \* Soft Start
- \* Load Response Control
- \* W/Capacitor Inside
- \* Repair Circuit: VR-H2005-18AS
- \* Voltage Set Point: 14.4V

**Replaces**

**DENSO :**  
126000-1260    126000-1270    126000-1190    126000-1400    126000-1500

**TOYOTA :**  
27700-46030    27700-46040    27700-72090

**Unit no.**

DENSO  
100211-5360    100211-6180    100211-6300    100211-6330    100211-6340    100211-6360  
100211-7910    100211-7930



**VR-H2005-196**

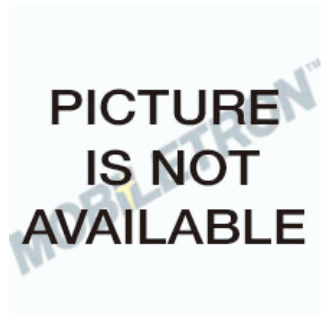

**Replaces**

**DENSO :**  
126000-2100

**Unit no.**

DENSO  
101211-9230  
HONDA  
31100-P2C-0030

**VR-H2005-197**

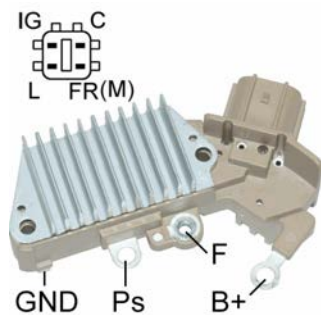

- \*IG-C-L-FR Terminals
- \*Soft Start
- \*2.5 sec. LRC
- \*Short Circuit Protection
- \*Voltage Set Point:14.1V

**Replaces**

**DENSO :**  
126000-3370  
**TOYOTA :**  
27700-21040

**Unit no.**

DENSO  
102211-0920  
TOYOTA  
27060-28160

**Used On**

**TOYOTA**

Camry  
Corolla  
Premio

2001-2003  
2002-on  
2001-on

**VR-H2005-198**

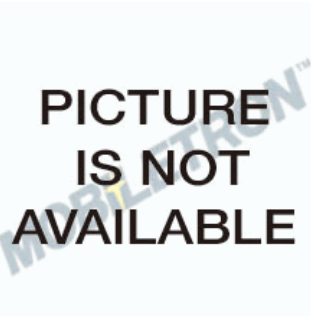

**Unit no.**

DENSO			
DAN1093	104211-3090	DAN1094	104211-3130
TOYOTA			
27060-0Y130	27060-0Y160	27060-0N100	

**Used On**

<b>TOYOTA</b>	
Yaris	2012-
Corolla	2013-
Auris	2013-

**VR-H2005-199**

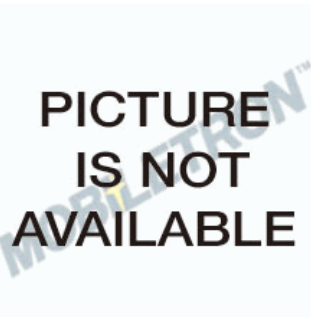

**Replaces**

**DENSO :**  
104210-8070

**Unit no.**

TOYOTA  
27060-28220

**VR-H2005-19A**



- \* D-FR-IG-L Terminals
- \* 63.5mm Mounting Length
- \* L Terminal Drives Choke
- \* Load Response Control
- \* Soft Start
- \* W/Capacitor Inside
- \* Voltage Set Point:14.4V

**Replaces**

**DENSO :**  
126000-1470

**Unit no.**

DENSO		
100211-8910	100211-9100	
HONDA		
31100-PR4-C01		

**VR-H2005-2**

\* W/Capacitor Inside  
 \*Voltage Set Point:14.4V

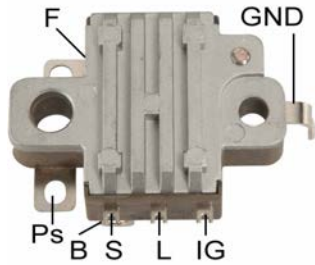

**Replaces**

**DENSO :**  
 126000-0920      126000-1460  
**TOYOTA :**  
 27000-64040      27700-64110

**Unit no.**

DENSO					
100213-0750	100213-0760	100213-0950	100213-0980	100213-1120	100213-1210
100213-1450	100213-1500				
TOYOTA					
27040-64070	27040-64080	27040-64110	27040-64130	27040-64131	27040-64140
27040-64141					

**VR-H2005-200**

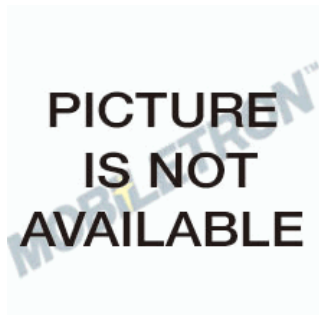

**Replaces**

**DENSO :**  
 126000-3290

**Unit no.**

DENSO					
101211-9570	102211-1780	102211-2220	102211-2221	102211-2222	102211-2223
102211-2270					

**VR-H2005-203**

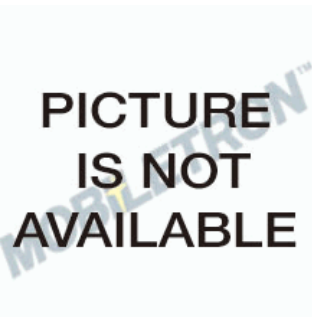

**Unit no.**

ACURA  
 31100-R8A-A01 31100-R8A-A01RMC SJ89  
 DENSO  
 104210-1890 104211-8270 104211-8300 104211-8510  
 HONDA  
 31100-5G0-A02 31100-5G0-A02RM

**Used On**

**HONDA**  
 Acura Truck RDX 3.5L 2013-2014  
 Accord V6 3.5L 2013-2014

**VR-H2005-208**

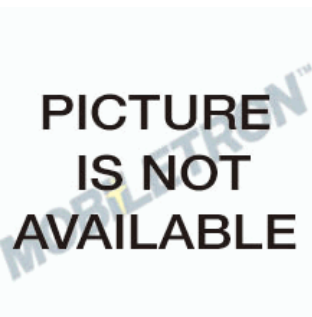

**Replaces**

**DENSO :**  
 126000-3080 126000-3081

**Unit no.**

TOYOTA  
 27060-27030

**Used On**

**TOYOTA**  
 Avensis 2.0L 1997-2003  
 Corolla 2.0L 1997-on

## VR-H2005-23A



- \* S-IG-L Terminals
- \* 57.5mm Mounting Length
- \* L Terminal Drives Choke
- \* Soft Start
- \* Load Response Control
- \* W/Capacitor Inside
- \* Repair Circuit: VR-H2005-23AS
- \* Voltage Set Point: 14.4V

### Replaces

#### DENSO :

126000-0550      126000-0980      126000-0900      126000-0901      126000-1550      126000-1570

#### LUCAS :

UCJ423

#### MAGNETI MARELLI :

940038087

#### TOYOTA :

27700-10050      27700-10080

### Unit no.

#### DENSO

100211-1520      100211-1560      100211-1620      100211-4160      100211-4170      100211-4290

100211-4320      100211-4350      100211-4410      100211-6860

#### TOYOTA

27060-10070      27060-10071      27060-10100      27060-11080      27060-72080      27060-72081

27060-72140

## VR-H2005-24

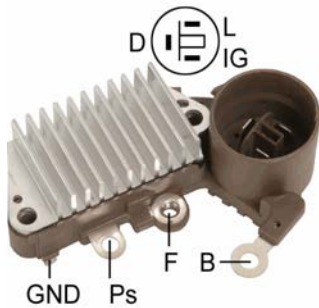

- \* D-IG-L Terminals
- \* 57.5mm Mounting Length
- \* L Terminal Drives Choke
- \* W/Capacitor Inside
- \* Repair Circuit: VR-H2005-15S
- \* Voltage Set Point: 14.4V

### Replaces

#### DENSO :

126000-0850      126000-0880

#### ISUZU :

8-94455-160

### Unit no.

#### DENSO

100211-4130      100211-4260      100211-6600      100211-6720

#### ISUZU

8-94449-781-0

#### SUZUKI

31400-60B40

**VR-H2005-25**

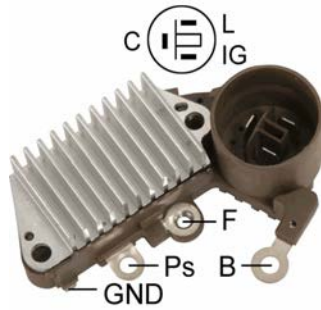

- \* C-IG-L Terminals
- \* 57.5mm Mounting Length
- \* L Terminal Drives Choke
- \* W/Capacitor Inside
- \* Repair Circuit: VR-H2005-25S
- \* Voltage Set Point: 14.4V

**Replaces**

**DENSO :**  
126000-0840

**Unit no.**

DENSO  
100211-4150      100211-4110  
GM  
96056770  
SUZUKI  
31400-86210

**VR-H2005-26A**



- \* D-IG-L Terminals
- \* 57.5mm Mounting Length
- \* L Terminal Does Not Drive Choke
- \* W/Capacitor Inside
- \* Repair Circuit: VR-H2005-26AS
- \* Voltage Set Point: 14.4V

**Replaces**

**DENSO :**  
126000-0721      126000-0950      126000-1330      126000-2120      126000-2720      126000-2810  
126000-0720

**ISUZU :**  
8-94455160-0

**SUZUKI :**  
32500-86511

**Unit no.**

DENSO  
100211-1550      100211-1570      100211-6720  
SUZUKI  
31400-60840      31400-86010      31400-86510



## VR-H2005-28

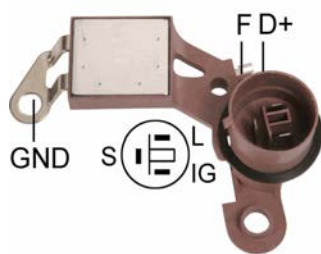

- \* S-IG-L Terminals
- \* Repair Circuit: VR-H2005-3S
- \* Voltage Set Point:14.4V

### Replaces

#### DENSO :

126000-0360      126000-0460      126000-0500      126000-0670

#### Unit no.

#### DENSO

100211-0680      100211-0730      100211-0760      100211-0780      100211-0870      100211-0930

100211-2570      100211-2630      100211-2980      100211-2990      100211-5760      100211-5930

#### HINO

27040-1240A      27040-1261A

#### TOYOTA

27060-16030      27060-61090      27060-63010      27060-63070      27060-72020      27060-72030

27060-72040

## VR-H2005-29

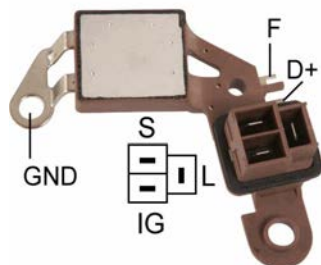

- \* L-S-IG Terminals
- \* Repair Circuit: VR-H2005-3S
- \* Voltage Set Point:14.4V

### Replaces

#### DENSO :

126000-0270

#### ISUZU :

8-94239-079-0

#### Unit no.

#### DENSO

100211-0581      100211-0990

#### KUBOTA

15451-99371

**VR-H2005-2W**

\* W/Capacitor Inside  
 \* Voltage Set Point: 14.4V



**Replaces**

**DENSO :**  
 126000-0920      126000-1460  
**TOYOTA :**  
 27000-64040

**Unit no.**

DENSO					
100213-0750	100213-0760	100213-0950	100213-0980	100213-1120	100213-1210
100213-1450	100213-1500				
TOYOTA					
27040-64070	27040-64080	27040-64110	27040-64130	27040-64131	27040-64140
27040-64141					

**VR-H2005-3**

\* S-IG-L Terminals  
 \* Repair Circuit: VR-H2005-3S  
 \* Voltage Set Point: 14.4V

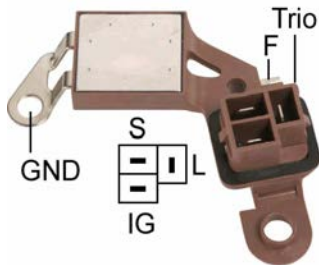

**Replaces**

**BOSCH :**  
 0-986-192-023  
**DENSO :**  
 126000-0170      126000-0450      126000-0490      126000-1809  
**TOYOTA :**  
 27700-43010      27700-44040

**Unit no.**

DENSO					
100211-0270	100211-0500	100211-0530	100211-0540	100211-0550	100211-0560
100211-0590	100211-0600	100211-0610	100211-0620	100211-0630	100211-0640
100211-0650	100211-0660	100211-0670	100211-0680	100211-0700	100211-0710
100211-0750					
TOYOTA					
27020-16010	27020-16030	27020-16040	27020-43060	27060-10030	27060-15011
27060-28030	27060-28050	27060-34020	27060-34030	27060-34040	27060-43010
27060-43020	27060-43030	27060-43040	27060-43060	27060-43070	27060-43080
27060-43090	27060-44010	27060-63010	27060-70040	27060-70060	27060-70062

**VR-H2005-30A**



- \* S-IG-L Terminals
- \* 63.5mm Mounting Length
- \* L Terminal Drive Choke
- \* Load Response Control
- \* Soft Start
- \* W/Capacitor Inside
- \* Voltage Set Point:14.4V

**Replaces**

**DENSO :**

126000-1960	126000-2050	126000-2200	126000-2230	126000-2250	126000-1730
126000-1750	126000-1930				

**TOYOTA :**

27700-11070	27700-66040	27700-50020	27700-50030	27700-54060	27700-74040
-------------	-------------	-------------	-------------	-------------	-------------

**Unit no.**

**DENSO**

101211-0100	101211-0190	101211-0340	101211-0350	101211-0430	101211-0450
101211-0520	101211-5080	101211-5150	101211-5160		

**TOYOTA**

27060-02050	27060-02070	27060-11270	27060-11280	27060-11290	27060-11300
27060-11320	27060-15100	27060-15110	27060-35150	27060-62090	27060-66040
27060-74460	27060-75100				

**VR-H2005-31A**



- \* S-IG-L Terminals
- \* 63.5mm Mounting Length
- \* L Terminal Does Not Drive Choke
- \* Soft Start
- \* Load Response Control
- \* W/Capacitor Inside
- \* Repair Circuit: VR-H2005-18AS
- \* Voltage Set Point:14.4V

**Replaces**

**DENSO :**

126000-1580	126000-1640	126000-1660	126000-1540	126000-1670	126000-2290
126000-7100	126000-7110				

**TOYOTA :**

27700-40050	27700-65010	27700-35040	27700-74030		
-------------	-------------	-------------	-------------	--	--

**Unit no.**

**DENSO**

100211-0050	100211-5020	100211-5110	100211-6460	100211-6480	101211-0060
101211-0070	101211-0140	101211-0210	101211-0270	101211-0380	101211-0390
101211-5000	101211-5010	101211-5120	101211-5130	101211-5170	101211-5370
101211-5380	101211-5460	101211-5550	101211-5640	101211-5660	101211-5720
101211-5750	101211-5760	101211-5770	101211-5900	101211-5970	101211-7010
101211-7060	101211-7100	101211-7510	101211-9960		

**TOYOTA**

27060-0D010	27060-11281	27060-15080	27060-15090	27060-15150	27060-16320
27060-16330	27060-16340	27060-17160	27060-17180	27060-50090	27060-50100
27060-55070	27060-55080	27060-62080	27060-64100	27060-64130	27060-64150
27060-64190	27060-64200	27060-65050	27060-70410	27060-70430	27060-72350
27060-72360	27060-72370	27060-74360	27060-74370	27060-74430	27060-74440
27060-75110	27060-75120	27060-76180			

**Used On**

**TOYOTA**

Corolla 4Cyl. 1.8L	2002-
--------------------	-------

**VR-H2005-32A**



- \* S-IG-L Terminals
- \* 57.5mm Mounting Length
- \* L Terminal Drives Choke
- \* Load Response Control
- \* Soft Start
- \* W/Capacitor Inside
- \* Voltage Set Point:14.4V

**Replaces**

**DENSO :**  
126000-1630      126000-959

**TOYOTA :**  
27700-11060

**Unit no.**

DENSO  
100211-2130  
TOYOTA  
27060-11250

**VR-H2005-33A**



- \* S-IG-L Terminals
- \* 63.5mm Mounting Length
- \* L Terminal Does Not Drive Choke
- \* Soft Start
- \* W/Capacitor Inside
- \* Repair Circuit: VR-H2005-33AS
- \* Voltage Set Point:14.4V

**Replaces**

**DENSO :**  
126000-0610      126000-1110

**TOYOTA :**  
27700-74010

**Unit no.**

DENSO

100211-5210	100211-6110	100211-7470	100211-7780	100211-7960	100211-8380
100211-8450	100211-8470	100211-8480	100211-8500	100211-8590	

TOYOTA

27060-46010	27060-46020	27060-62050	27060-65030	27060-74090	27060-74170
27060-74180	27060-74190	27060-74210	27060-74220	27060-74240	27060-74280
27060-74281					

## VR-H2005-34



- \* L Terminal
- \* 63.5mm Mounting Length
- \* L Terminal Drives Choke.
- \* W/Capacitor Inside
- \* Voltage Set Point:14.4V

### Replaces

#### DENSO :

126000-1130      126000-1760      126000-7160

#### Unit no.

#### DENSO

100211-8370      100211-8620      100211-8630

## VR-H2005-35



- \* S-IG-L Terminals
- \* 63.5mm Mounting Length
- \* L Terminal Does Not Drive Choke
- \* W/Capacitor Inside
- \* Voltage Set Point:14.6V

### Replaces

#### DENSO :

126000-7100

#### Unit no.

#### DENSO

101211-0130      101211-0300      101211-7010

## VR-H2005-36A



- \* S-IG-L Terminals
- \* 63.5mm Mounting Length
- \* L Terminal Drives Choke
- \* Load Response Control
- \* Soft Start
- \* W/Capacitor Inside
- \* Voltage Set Point:14.4V

#### Unit no.

#### DENSO

100211-5620

**VR-H2005-37A**

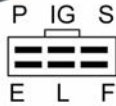

- \* L Terminal Drives Choke
- \* Soft Start
- \* 8.5 sec. LRC
- \* W/Capacitor Inside
- \* Voltage Set Point:14.4V

**Replaces**

**BOSCH :**

0-986-192-024

**DENSO :**

126000-0300      126000-0301      126000-0302      126000-0420

**HONDA :**

31400-SA5-004    31400-SA5-671    31400-SA5-A0300   31400-SB0-004

**Unit no.**

DENSO

021000-977      021000-983

HONDA

31100-PC1-004    31100-PC1-020    31100-PC1-971

**VR-H2005-39**



- \* L-IG Terminals
- \* 57.5mm Mounting Length
- \* L Terminal Does Not Drive Choke
- \* W/Capacitor Inside
- \* Repair Circuit: VR-H2005-26AS
- \* Voltage Set Point:14.4V

**Replaces**

**DAIHATSU :**

27700-87207      27700-96301

**DENSO :**

126000-0600

**ISEKI :**

281-271-001-0

**TOYOTA :**

27700-78301

**Unit no.**

DENSO

100211-1550      100211-1670      100211-1680

ISHIKAWAJIMA

18504-6220

MITSUBISHI MOTORS

MD604589

**VR-H2005-39SE**

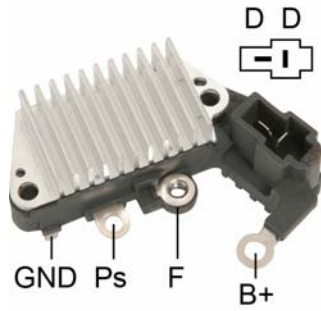

- \* 57.5mm Mounting Length
- \* Self Exciting
- \* W/Capacitor Inside
- \* Voltage Set Point:14.6V

**Replaces**

**DENSO :**  
 126000-0600      126000-0760      126000-1160

**Unit no.**

DENSO					
100211-1511	100211-1540	100211-1550	100211-1580	100211-1590	100211-1610
100211-1630	100211-1650	100211-1662	100211-1670	100211-1680	100211-1690
100211-4050	100211-4060	100211-4080	100211-4091	100211-4180	100211-4200
100211-4210	100211-4220	100211-4230	100211-4240	100211-4250	100211-4360
100211-4382	100211-4460	100211-4482	100211-4520	100211-4550	100211-4560
100211-4700	100211-6221	100211-6640	100211-6760	100211-6770	100211-6880
100211-6890	100211-6900	100211-6920			

**VR-H2005-40**



- \* IG-C-L-FR Terminals
- \* 63.5mm Mounting Length
- \* Soft Start
- \* 2.5 Sec. LRC
- \* Short Circuit Protection
- \* L Terminal Does Not Drive Choke
- \* W/O.47μF Capacitor Inside
- \* Repair Circuit: VR-H2005-22S
- \* Voltage Set Point:14.4V

**Replaces**

**DENSO :**  
 126000-2090      126000-2160      126000-2170      126000-2470      126000-2610

**HONDA :**  
 31150-P2T-0030

**MAGNETI MARELLI :**  
 940038097

**Unit no.**

DENSO			
101211-9380	101211-9390	101211-9820	102211-1260

## VR-H2005-40A



- \* IG-C-L-FR Terminals
- \* 63.5mm Mounting Length
- \* Soft Start
- \* 2.5 sec. LRC
- \* Short Circuit Protection
- \* L Terminal Does Not Drive Choke
- \* W/ 2.7 $\mu$ F Capacitor Outside
- \* Voltage Set Point: 15.1V

### Replaces

**DENSO :**  
126000-3430

### Unit no.

DENSO  
102211-086      102211-087  
JAGUAR  
XR822418

## VR-H2005-40T



- \* Same as VR-H2005-40 w/choke function

## VR-H2005-45A



- \* S-IG-L Terminals
- \* 63.5mm Mounting Length
- \* L Terminal Drive Choke
- \* Soft Start
- \* Load Response Control
- \* W/Capacitor Inside
- \* Repair Circuit: VR-H2005-4AS
- \* Voltage Set Point: 14.4V

### Replaces

**DENSO :**  
126000-1520      126000-1521



**VR-H2005-46A**



- \* S-IG-L Terminals
- \* 63.5mm Mounting Length
- \* L Terminal Does Not Drive Choke
- \* Soft Start
- \* W/Capacitor Inside
- \* Repair Circuit: VR-H2005-33AS
- \* Voltage Set Point:14.4V

**Replaces**

**DENSO :**

126000-1670	126000-2050	126000-2200	126000-2230	126000-7100
-------------	-------------	-------------	-------------	-------------

**Unit no.**

DENSO

101211-0300	101211-7300	101211-7301	101211-7760	101211-7761
-------------	-------------	-------------	-------------	-------------

**VR-H2005-48A**

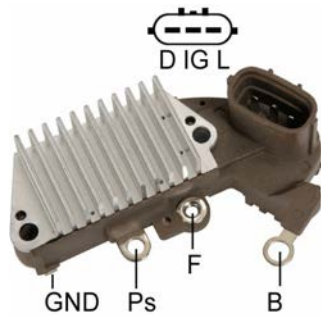

- \* D-IG-L Terminals
- \* 63.5mm Mounting Length
- \* L Terminal Does Not Drive Choke
- \* Soft Start
- \* Load Response Control
- \* W/Capacitor Inside
- \* Repair Circuit: VR-H2005-48AS
- \* Voltage Set Point:14.4V

**Replaces**

**DENSO :**

126000-1920	126000-1970	126000-1971	126000-1977	126000-2680	126000-2740
126000-3060	126000-3530				

**Unit no.**

DENSO

101211-0550	101211-0720	102211-5070
-------------	-------------	-------------

SUZUKI

31400-60G11	31400-60G12
-------------	-------------

## VR-H2005-4A



- \* S-IG-L Terminals
- \* 63.5mm Mounting Length
- \* L Terminal Drives Choke
- \* Soft Start
- \* W/Capacitor Inside
- \* Repair Circuit: VR-H2005-4AS
- \* Voltage Set Point:14.4V

### Replaces

#### BOSCH :

0-986-192-021

#### DENSO :

126000-0330	126000-0400	126000-0731	126000-0732	126000-0931	126000-0932
126000-1010	126000-1450	126000-1560	126000-7090	126000-0340	126000-0510
126000-0650	126000-0700	126000-1530			

#### GM :

94139012      94840314

#### HONDA :

31150-PD1-004    31150-PD2-004    31150-PDJ-004

#### ISUZU :

8-9413-053-0

#### LUCAS :

UCB412

#### TOYOTA :

27700-01010	27700-63021	27700-72070	27700-10061	27700-11030	27700-11050
27700-54050	27700-63020	27700-70030	27700-72040	27700-72041	

### Unit no.

#### DENSO

100211-1000	100211-1001	100211-1011	100211-1021	100211-1031	100211-1040
100211-1041	100211-1050	100211-1060	100211-1061	100211-1070	100211-1074
100211-1080	100211-1090	100211-1091	100211-1110	100211-1131	100211-1141
100211-1180	100211-1200	100211-1210	100211-1220	100211-1230	100211-1320
100211-1340	100211-1360	100211-2020	100211-2030	100211-2050	100211-2060
100211-2070	100211-2100	100211-2150	100211-2170	100211-2210	100211-2250
100211-2280	100211-2370	100211-2380	100211-2400	100211-2500	100211-2830
100211-2840	100211-3030	100211-3040	100211-3060	100211-3090	100211-3110
100211-3150	100211-3180	100211-3220	100211-3260	100211-3300	100211-3320
100211-3350	100211-3390	100211-3430	100211-3500	100211-3510	100211-3520
100211-3530	100211-3540	100211-3550	100211-3610	100211-3630	100211-3770
100211-3820	100211-3960	100211-7000	100211-7050	100211-7060	100211-7460
100211-7570	100211-7800	100211-7970	100211-8300	100211-8540	100211-9710

#### HONDA

31100-PD1-014	31100-PD1-024	31100-PD2-004	31100-PD2-014	31100-PD2-024	31100-PD2-970
31100-PD2-973	31100-PE0-003	31100-PE0-921	31100-PE2-003	31100-PH1-004	31100-PH1-014
31100-PH1-024	31100-PK1-004				

#### ISUZU

8-94109-911-5    8-94120-564-4    8-94131-357-2    8-94408-674-0

#### TOYOTA

27040-64040	27040-64050	27060-10010	27060-10011	27060-13090	27060-15040
27060-16010	27060-16012	27060-16040	27060-16050	27060-16080	27060-16082
27060-16091	27060-16122	27060-16131	27060-16140	27060-16160	27060-16170
27060-35060	27060-42030	27060-43060	27060-43062	27060-43110	27060-43111
27060-43130	27060-43140	27060-63020	27060-63021	27060-63030	27060-63040
27060-63041	27060-63080	27060-63082	27060-63100	27060-63101	27060-63102
27060-72010	27060-72050	27060-72060	27060-72061	27060-72070	27060-72071
27060-72100	27060-72101	27060-74101	27060-16090		

**VR-H2005-50A**



- \* S-IG-L Terminals
- \* 57.5mm Mounting Length
- \* L Terminal Drives Choke
- \* Load Response Control
- \* Soft Start
- \* W/Capacitor Inside
- \* Voltage Set Point:14.4V

**Replaces**

**DENSO :**  
126000-1740

**VR-H2005-52A**



- \* S-IG-L Terminals
- \* 57.5mm Mounting Length
- \* L Terminal Does Not Drive Choke
- \* Load Response Control
- \* Soft Start
- \* W/Capacitor Inside
- \* Voltage Set Point:14.4V

**Replaces**

**DENSO :**  
126000-2400

**Unit no.**

DENSO  
101211-373      101211-858

**VR-H2005-58**



- \* 24V
- \* S-IG-L Terminals
- \* L Terminal Does Not Drive Choke
- \* W/Capacitor Inside
- \* 63.5mm Mounting Length
- \* Voltage Set Point:28.3V

**Replaces**

**DENSO :**  
126000-7010      126000-7011      126000-2340

**TOYOTA :**  
27700-58020

**Unit no.**

DENSO  
100211-6200      100211-6210      100211-6221

## VR-H2005-59

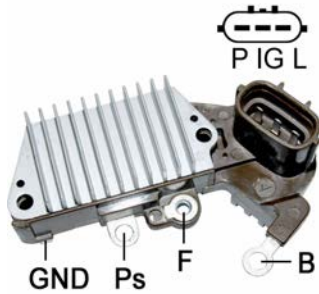

- \* P-IG-L Terminals
- \* W/Capacitor Inside
- \* 63.5mm Mounting Length
- \* Voltage Set Point:14.4V

### Replaces

#### DENSO :

126000-1940	126000-2181	101211-0690	101211-4280	101211-9010	101211-9020
101211-9940	102211-1440	102211-1820	102211-1830	102211-9010	

#### KUBOTA :

19260-64011	19260-64012	19279-64010	19279-64011	19279-64012	
-------------	-------------	-------------	-------------	-------------	--

#### PRESTOLITE :

20130227	20130227				
----------	----------	--	--	--	--

#### YANMAR :

119773-77200					
--------------	--	--	--	--	--

### Unit no.

#### DENSO

101211-9010	101211-9020	101211-9940	101211-0690	101211-4280	101211-9010
101211-9020	101211-9940	102211-1440	102211-1820	102211-1830	102211-9010

## VR-H2005-5H

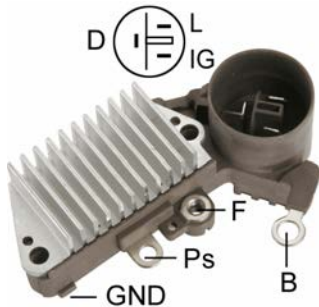

- \* D-IG-L Terminals
- \* 63.5mm Mounting Length
- \* L Terminal Drives Choke
- \* W/Capacitor Inside
- \* Repair Circuit:VR-H2005-5S
- \* Voltage Set Point:14.4V

### Replaces

#### DENSO :

126000-0430					
-------------	--	--	--	--	--

#### ISUZU :

8-94139-012-0					
---------------	--	--	--	--	--

### Unit no.

#### DENSO

100211-1270	100211-1271	100211-1331	100211-1371	100211-1380	
-------------	-------------	-------------	-------------	-------------	--

#### ISUZU

8-94137-345-2					
---------------	--	--	--	--	--

**VR-H2005-60**

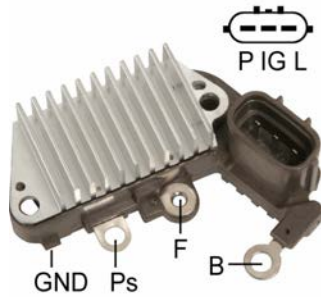

- \* P-IG-L Terminals
- \* Soft Start
- \* 2.5 sec. LRC
- \* W/Capacitor Inside
- \* 57.5mm Mounting Length
- \* Voltage Set Point:14.4V

**Replaces**

**DENSO :**  
126000-1800

**Unit no.**

DENSO  
101211-2310

**VR-H2005-62A**



- \* FR-IG-L Terminals
- \* Soft Start
- \* 2.5 sec. LRC
- \* Short Circuit Protection
- \* W/Capacitor Inside
- \* 63.5mm Mounting Length
- \* L Terminal Does Not Drive Choke
- \* Repair Circuits:VR-H2005-62AS
- \* Voltage Set Point:14.4V

**Replaces**

**DENSO :**  
126000-3040      126000-2861

**Unit no.**

DENSO  
102211-1860      102211-9820      102211-9880      102211-5210      102211-5250      102211-5410

HONDA  
31100-P2E-G01      31100-P7F-00331

TOYOTA  
27060-23010      27060-23070

**VR-H2005-63A**



- \* S-IG-L Terminals
- \* 63.5mm Mfg. Length
- \* L Terminal Does Not Drive Choke
- \* Load Response Control
- \* Soft Start
- \* 8.5 sec. LRC
- \* W/Capacitor Inside
- \* Voltage Set Point:14.4V

**Replaces**

**DENSO :**  
126000-1870      126000-2260

**TOYOTA :**  
27700-20050      27700-46060      27700-62010      27700-64130

**Used On**

**TOYOTA**

Corolla 4Cyl. 1.8L	2003-2007
RAV4 4Cyl. 2.4L	2004-2005
RAV4 2.0 4Cyl. 2.0L	2003-

**VR-H2005-64A**

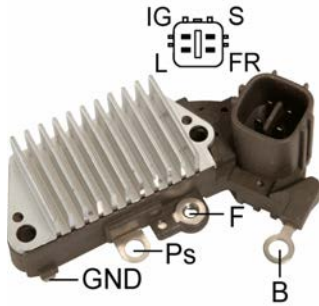

- \* IG-S-L-FR Terminals
- \* 63.5mm Mfg.Length
- \* L Terminal Does Not Drive Choke
- \* Load Response Control
- \* Soft Start
- \* W/Capacitor Inside
- \* Repair Circuit:VR-H2005-64AS
- \* Voltage Set Point:14.4V

**Replaces**

**DENSO :**  
126000-2190      126000-3690

**TOYOTA :**  
27700-50040

**Unit no.**

DENSO					
102211-2310	102211-2810	104210-4460	104210-8020	104210-8240	104210 -8241
104210 -9010	104210-9011	104210-9340.	104210-800	104210-801	101211-7230
101211-7270					
HONDA					
31100-P5A-003					
TOYOTA					
27060-50300	27060-62240	27060-0L020	27060-0L021	27060 -0L030	27060-0L040
27060-30010	27060-30040	27060-30050	27060-30080	27060-30120	27060-30150
27060-30151					

**VR-H2005-65**



- \* M-IG-L Terminals
- \* 63.5mm Mounting Length
- \* L Terminal Does Not Drive Choke
- \* Load Response Control
- \* Soft Start
- \* W/Capacitor Inside
- \* Voltage Setting:14.4V

**Replaces**

**DENSO :**  
126000-3170      126000-3171

**TOYOTA :**  
27700-21020

**Unit no.**

DENSO	
100211-5380	100211-5480

## VR-H2005-66



- \* S-IG-L Terminals
- \* W/Capacitor Inside
- \* L Terminal Does Not Drive Choke
- \* 63.5mm Mounting Length
- \* Voltage Set Point:28.3V

### Replaces

**DENSO :**  
126000-7120

**TOYOTA :**  
27700-58040

### Unit no.

DENSO			
100211-6240	100211-6250	100211-6260	
TOYOTA			
27060-17120	27060-58150	27060-58230	27060-58250

## VR-H2005-6H



- \* C-IG-L Terminals
- \* 63.5mm Mounting Length
- \* Soft Start
- \* 2.5 sec. LRC
- \* L Terminal Drives Choke
- \* W/Capacitor Inside
- \* Repair Circuit:VR-H2005-6S
- \* Voltage Set Point:14.4V

### Replaces

**DENSO :**  
126000-0440

**HONDA :**  
31150-PE0-921

### Unit no.

DENSO
100211-1260
HONDA
31100-PE0-924

## VR-H2005-77

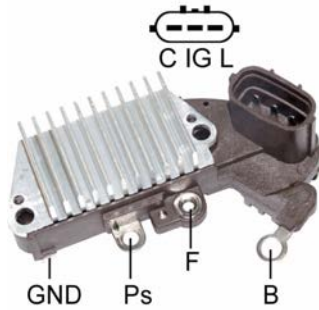

- \* C-IG-L Terminals
- \* 63.5mm Mounting Length
- \* L Terminal Drives Choke
- \* W/Capacitor Inside
- \* Voltage Set Point: 14.4V

### Replaces

#### DENSO :

126000-2150      126000-2151

#### ISUZU :

8-97122796-0

#### Unit no.

DENSO

101211-4220

ISUZU

29012-37800      29012-37801      89710-97800      89710-97801

## VR-H2005-7A



- \* D-IG-L Terminals
- \* 63.5mm Mounting Length
- \* L Terminal Does Not Drive Choke
- \* W/Capacitor Inside
- \* Repair Circuit: VR-H2005-7S
- \* Voltage Set Point: 14.4V

### Replaces

#### BOSCH :

0-986-192-022

#### DENSO :

126000-0410      126000-0411      126000-0470

#### GM :

96052000

#### HONDA :

31150-PE0-003

#### MAGNETI MARELLI :

943241001      MSR1001

#### SUZUKI :

32500-82610

#### Unit no.

DENSO

100211-1400      100211-1411

SUZUKI

9605-1973      9605-4116



**VR-H2005-8**

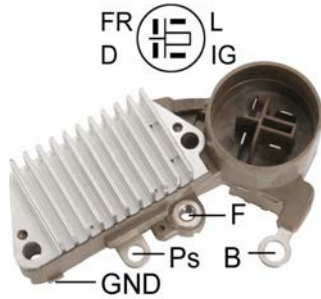

- \* D-FR-IG-L Terminals
- \* 63.5mm Mounting Length
- \* L Terminal Drives Choke
- \* W/Capacitor Inside
- \* Voltage Set Point:14.4V

**Replaces**

**DENSO :**

126000-0570

**HONDA :**

31150-PE7-661    31150-PE7-6620

**Unit no.**

DENSO

100211-1351    100211-1370    100211-7330

HONDA

31100-P3003    31100-PE7-660    31100-PE7-661    31100-PG7-013

**VR-H2005-81**



- \* M-IG-L Terminals
- \* 63.5mm Mounting Length
- \* L Terminal Does Not Drive Choke
- \* Soft Start
- \* Load Response Control
- \* W/Capacitor Inside
- \* Voltage Set Point:14.2V

**Unit no.**

DENSO

102211-167    102211-168

TOYOTA

27060-23020    27060-23030

**VR-H2005-82**



- \* M-IG-L Terminals
- \* 63.5mm Mounting Length
- \* Load Response Control
- \* Soft Start
- \* W/Capacitor Inside
- \* Voltage Set Point:14.4V

**Replaces**

**DENSO :**

126000-2871

**Unit no.**

DENSO

102211-1471

## VR-H2005-83

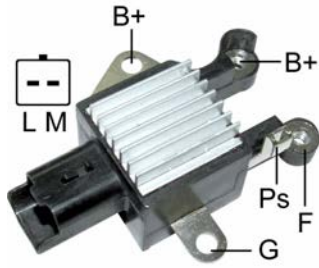

- \* M-L Terminals
- \* Soft Start
- \* 2.5 sec. LRC
- \* Short Circuit Protected
- \* W/Capacitor Inside
- \* Voltage Set Point: 14.4V

### Replaces

DENSO :

N810F01288      ST17001

### Unit no.

DENSO

104210-3170      104210-3240

## VR-H2005-85

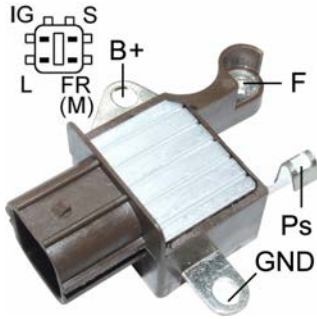

- \* IG-S-L-FR Terminals
- \* Soft Start
- \* 6.0 sec. LRC
- \* Short Circuit Protection
- \* Inactive Lamp
- \* W/Capacitor Inside
- \* Voltage Set Point:14.2V

### Replaces

<b>DENSO :</b>			
126600-3010	126600-3040	126600-3390	126600-3360
<b>TOYOTA :</b>			
27060-0C021	27060-0C020	27700-20090	27700-20100

### Unit no.

<b>DENSO</b>					
104210-345	104210-362	104210-365	104210-375	104210-403	104210-404
104210-418	104210-1461	104210-2100	104210-3450	966421-9345	104210-3750
104210-3751	9664219-375	104210-4880	104210-4881	104210-2360	104210-2350
104210-2341	104210-2650				
<b>TOYOTA</b>					
27060-0T130	27060-0V010	27060-0V060	27060-0A110	27060-0A120	27060-0A130
27060-0A140	27060-0H100	27060-0H110	27060-20270	27060-20280	27060-28260
27060-28290	27060-0V030	27060-OP240			

### Used On

<b>LEXUS</b>		
ES330	3.3L	2004-2006
<b>TOYOTA</b>		
Camry 4Cyl. 2.4L		2007-2010
Highlander	3.3L	2004-2007
Solara	2.4L	2004-2006
Camry 4Cyl. 2.5L		2009-2013
Corolla 4Cyl. 1.8L		2008-2013
Corolla 4Cyl. 2.4L		2008-2011
Highlander 4Cyl. 2.4L		2007-
Highlander 4Cyl. 2.7L		2010-2013
Highlander 6Cyl. 3.3L		2007-
Highlander 6Cyl. 3.5L		2008-2013
RAV4 4Cyl. 2.4L		2004-2005
RAV4 4Cyl. 2.5L		2008-2012
RAV4 6Cyl. 3.5L		2009-
RAV4 6Cyl. 3.5L		2011-2012
Sienna 3.3L		2005-2007
Sienna 3.5L		2005-2012
INNOVA		2011-
KIJANG		2008-2011
Hilux		2008-2011
FORTUNER		2008-2011

**VR-H2005-87**



- \* D-IG-L Terminals
- \* Soft Start
- \* 2.5 sec. LRC
- \* 57.5mm Mounting Length
- \* Voltage Set Point:14.4V

**Replaces**

**DENSO :**  
126000-2490

**Unit no.**

TOYOTA  
27060-87726

**VR-H2005-88**

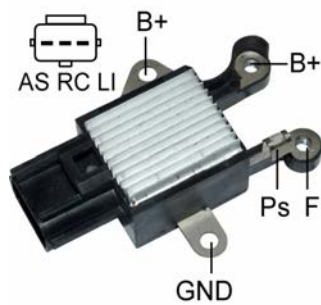

- \*A-Circuit
- \*AS-RC-LI Terminals
- \*Short Circuit Protection
- \*Voltage Set Point:14.2V
- \*Regulated Voltage Control(RVC)
- \*Requires RVC01 tester box for testing

**Replaces**

**DENSO :**  
PCM-01                    126600-3460

**Unit no.**

DENSO  
104210-3512    104210-4091    104210-4700    104210-5300    3M5T-10300-YD    104210-3511  
104210-3521    104210-3522    104210-3523    3M5T-10300-PC

**Used On**

**FORD**

Focus	2.0 TDCi	2003-
Foucs	1.6 TDCi	2003-

**VR-H2005-89**

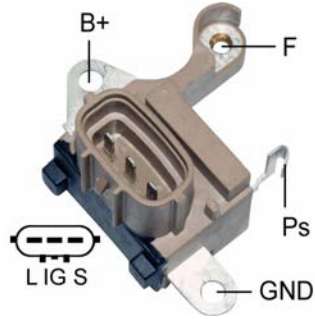

- \* S-IG-L Terminals
- \* Soft Start
- \* Short Circuit Protection
- \* W/Capacitor Inside
- \* Voltage Set Point:14.2V

**Replaces**

**DENSO :**  
126600-0011

**Unit no.**

DENSO  
104210-3030      104210-3031      104210-3920      104210-3921

**Used On**

**LEXUS**

LS430      2001-2008  
SC430      2001-2008

**VR-H2005-90**

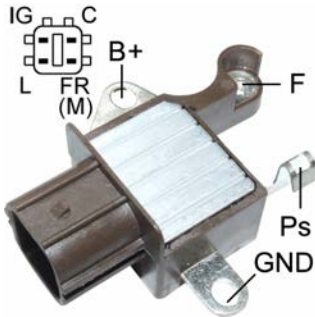

- \* IG-C-L-FR(M) Terminals
- \* B-Circuit
- \* Soft Start
- \* 8.5 sec. LRC
- \* Short Circuit Protection
- \* W/Capacitor Inside
- \* Voltage Set Point:14.4V

**Replaces**

**DENSO :**  
122600-0140      126600-3200      126600-3350      126600-0149

**HONDA :**  
31150-RAA-A030M 31150-RAA-A010M

**Unit no.**

DENSO  
104210-3290      104210-3291      104210-3292      104210-3293      104210-3970      104210-5470  
104210-5570      104210-5370      104210-1220      104210-4733      104210-5900

HONDA  
31100-R0A-0031      31100-RTA-0230      31100-RZP-G010      31100-PRC-0030      31100-RAA-A01      31100-RAA-A03  
31100-RAA-A04      31100-RAA-A05      31100-RTA-003      31100-RTA-013

TOYOTA  
27060-51010      27060-51020

**Used On**

**HONDA**

Accord 4Cyl. 2.4L      2007-  
Element      2.4L      2003-2006  
Civic 4Cyl. 2.0L      2006-2011  
CRV 4Cyl. 2.4L      2007-2011

**VR-H2005-91**



- \* IG-S-L-FR(M) Terminals
- \* B-Circuit
- \* Inactive Lamp
- \* Soft Start
- \* Short Circuit Protection
- \* W/Capacitor Inside
- \* Voltage Set Point:14.2V

**Replaces**

DENSO :  
126600-0150

**Unit no.**

DENSO					
104210-3380	104210-3381	104210-3390	104210-3440	104210-3460	104210-4460
104210-3410	104210-3490	104210-3860	204210-3400	104210-3461	
TOYOTA					
27060-30080					

**Used On**

**LEXUS**

LX470 2003-2005

**TOYOTA**

Land Cruiser 2003-2007

Sequoia 2003-2006

**VR-H2005-92**

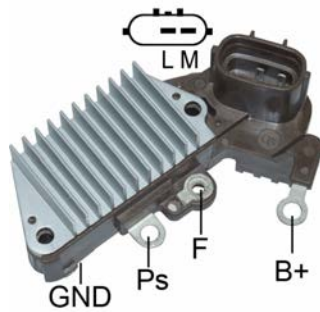

- \* L-M Terminals
- \* Soft Start
- \* 2.5 sec LRC
- \* Short Circuit Protection
- \* W/Capacitor Inside
- \* Voltage Set Point:14.4V

**Unit no.**

HYUNDAI	
37300-3C120	37300-3C170
POONG SUNG	
02131-9330	02131-9153

**Used On**

**HYUNDAI**

Sonata 6Cyl. 3.3L 2007-

Sonata 6Cyl. 3.3L 2009-



**VR-H2005-95**

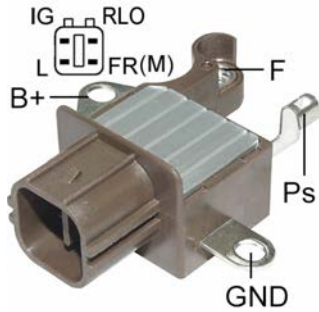

- \* RLO-IG-L-M Terminals
- \* W/Capacitor Inside
- \* Voltage Set Point: 14.2V
- \* Regulated Voltage Control(RVC)
- \* Requires RVC01 tester box & VR-RVC01W test adaptor for testing

**Replaces**

**DENSO :**

126600-3020	126600-3220	126600-3320
-------------	-------------	-------------

**Unit no.**

DENSO			
104210-209	104210-474	104210-475	104210-479
TOYOTA			
27060-28300	27060-31090	27060-31100	27060-31101

**Used On**

**TOYOTA**

RAV4 4Cyl. 2.4L	2006-2008
RAV4 6Cyl. 3.5L	2006-2008

**VR-H2005-96**

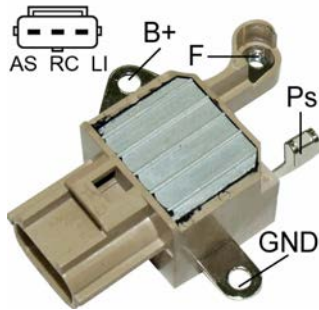

- \* B-Circuit
- \* AS-RC-LI Terminals
- \* W/Capacitor Inside
- \* Regulated Voltage Control(RVC)
- \* Used on 2nd Generation Ford Focus C-Max
- \* Requires RVC01 tester box for testing

**Replaces**

**DENSO :**

126600-3430	126600-3640
-------------	-------------

**Unit no.**

DENSO			
104210-3513	104210-3523	104210-6101	104210-6340
FORD			
7C3T-10300EE	BL3T-10300BC	3M5T-10300PB	3M5T-10300PD

**Used On**

**FORD**

Fiesta V(JH_,JD_)	1.6 TDCi 66kW	2004-
Focus C-MAX	1.6 TDCi 80kW	2003-2007
Focus II(DA_)	1.6 TDCi 80kW	2004-
Focus II(DA_)	2.0 TDCi 100kW	2004-
Fusion(JU_)	1.6 TDCi 66kW	2004-



**VR-H2005-99**

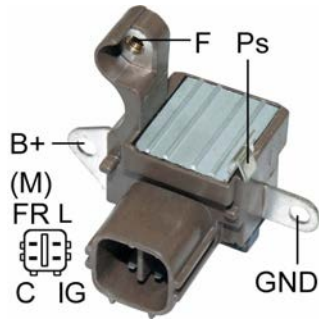

- \* Inactive Lamp
- \* IG-C-L-M(FR) Terminals
- \* Soft Start
- \* 2.5 sec. LRC
- \* Short Circuit Protection
- \* W/Capacitor Inside
- \* Voltage Set Point:14.4V

**Replaces**

**DENSO :**

126600-0041      126600-0042      126600-0040      126600-3070      126600-3150

**Unit no.**

**DENSO**

104210-309      104210-3091      104210-3092      104210-3500      104210-4481      104210-4690  
 104210-4290

**Used On**

**HONDA**

Accord 6Cyl. 3.5L      2007-  
 Odyssey 6Cyl. 3.5L      2007-

**VR-H2005-9A**

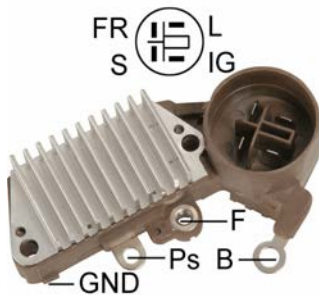

- \* S-FR-IG-L Terminals
- \* 63.5mm Mounting Length
- \* L Terminal Drives Choke
- \* Soft Start
- \* W/Capacitor Inside
- \* Repair Circuit: VR-H2005-9AS
- \* Voltage Set Point:14.4V

**Replaces**

**DENSO :**

126000-0540      126000-1170

**HONDA :**

31150-PD6-004      31150-PD6-014      31150-PD6-024      31150-PH3-013

**Unit no.**

**DENSO**

100211-2010      100211-2130      100211-2140      100211-2550      100211-3310      100211-7070  
 100211-7240      100211-7500

**HONDA**

31000-PH7-013      31100-PD6-014      31100-PH3-0243      31100-PH3-J01      31100-PH7-004      31100-PH7-013  
 31100-PH7-024      31100-PHJ-004      31100-PJ0-663      31100-PJ0-6633      31100-PK2-0031      31100-PK2-004  
 31100-PK2-0146      31100-PK2-0241      31100-PK3-A011      31100-PK3-A020M      31100-PP8-004

**VR-F341**



- \*Regitar No.:GR341
- \*Electronic type
- \*For use on Ford car & Trucks
- \*Voltage Set Point:14.5V

**Replaces**

**FORD :**  
 C3TZ-10316A    C3TZ-10316AA    C3TZ-10316B    D4TZ-10316A  
**MOTORCRAFT :**  
 GR341A    GR341B

**VR-F540A**



- \*Regitar No.:GR540A
- \*Short Circuit Protected
- \*For use on Ford car & Trucks
- \*Voltage Set Point:14.5V

**Replaces**

**FORD :**  
 D9PZ-10316A    E2PZ-10316A    E4AZ-10316B  
**MOTORCRAFT :**  
 GR504    GR533    GR534    GR540    GR540A

**VR-F540DH**



- \*Regitar No.:GR540DH
- \*Compatible With 7 Amp Rotors
- \*Digital Dash Compatible
- \*Short Circuit Protected
- \*For use on Ford, Mercurys & Lincolns
- \*Voltage Set Point:14.5V

**Replaces**

**FORD :**  
 E6DF-10316AA

**VR-F7078**

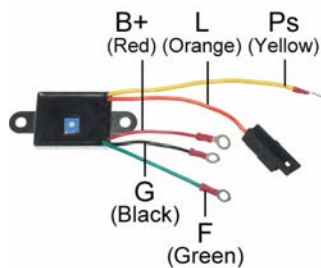

- \*Nominal Adjustable
- \*PS Open Lamp On
- \*Voltage Set Point:14.2V
- \*For Ford 1G Series 45-65A ER/EF Alternators

**VR-F756**

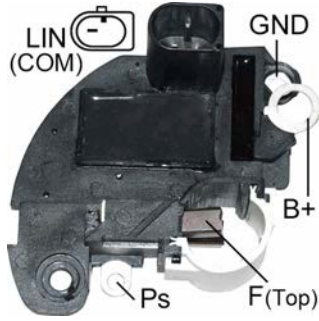

- \*B-Circuit
- \*Voltage Set Point: 13.7V
- \*LIN-1
- \*19200 Baud Rate (4 Byte)
- \*Requires COM01 test adaptor for testing

**Unit no.**

DENSO  
126600-756A      MS101210-1700

**Used On**

**ALFA ROMEO**

Mito 2008-2011

**FIAT**

Punto 2007-2010

500 2007-2011

Grande Punto 2007-2011

**VR-F784H**

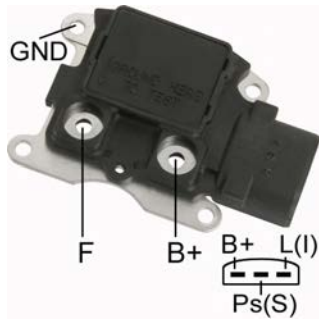

\*Regitar No.:GR784  
 \*For Use on: Ford 2G, 3G Alternators  
 \*Voltage Set Point:14.45V

**Replaces**

**FORD :**

E43F-10316AA	E43Z-10316A	E43Z-10316B	E63F-10316AA	E63F-10316AB	E6TZ-10316A
E43F-10316A	E6YZ-10316A	E73F-10316AB	E73F-10316AC	E73Z-10316A	GR748B
GR784	GR784A	GR784B			

**VALEO :**

VR-231

**Unit no.**

**FORD**

D53F-10300AA	D53F-10300BA	D53F-10300DA	D53F-10300EA	D53F-10300FA	D53F-10300GA
D53F-10300HA	D53F-10346BA	D53F-10346DA	E1AF-10300DA	E43F-10300EA	E43F-10300PA
E43F-10300RA	E43F-10346B	E43F-10346BA	E43Z-10346D	E53Z-10346A	E57F-10300AA
E57F-10300BA	E59F-10300DA	E5TZ-10346A	E63F-10300AB	E63F-10300BB	E63F-10300CB
E63F-10300DA	E63Z-10346A	E63Z-10346B	E67F-10300CA	E67F-10300DA	E67F-10300EA
E67F-10300FA	E67F-10346AA	E67F-10346CA	E67Z-10346A	E69F-10300AA	E69F-10300BA
E69F-10346AA	E69F-10346BA	E6AF-10300AA	E6AF-10300BA	E6DF-10300BA	E6DF-10300DA
E6DF-10300EA	E6DF-10300EB	E6DF-10300GA	E6DF-10346A	E6DF-10346CA	E6DZ-10346B
E6DZ-10346C	E6EF-10300EA	E6EF-10300FA	E6EF-10300GA	E6EF-10300HA	E6EF-10300JA
E6EF-10346AA	E6EF-10346CA	E6FZ-10346C	E6RZ-10346C	E6SF-10300BA	E6TF-10300AA
E6TF-10300BA	E6TF-10300CA	E6TF-10300DA	E6TZ-10346A	E6TZ-10346B	E6UF-10300AA
E6ZF-10300CA	E6ZZ-10346B	E73F-10300BA	E73F-10300CA	E79F-10300BA	E7AF-10300CA
E7DF-10300GA	E7EF-10300CB	E7EF-10300DB	E7EF-10300EB	E7EF-10300FB	E7EF-10300GA
E7PF-10346AA	E7PF-10346AZ	E7PF-10346BA	E7PF-10346CA	E7PF-10346DA	E7PF-10346FA
E7PF-10346GA	E7PF-10346KA	E7PF-10346LA	E7PF-10346MA	E7PF-10346NA	E7PF-10346UA
E7PF-10346XA	E7PY-10346A	E7PZ-10346C	E7PZ-10346D	E7PZ-10346E	E7PZ-10346F
E7PZ-10346G	E7PZ-10346H	E7PZ-10346J	E7PZ-10346K	E7PZ-10346L	E7PZ-10346M
E7PZ-10346N	E7SF-10300FA	E7SF-10300HA	E7SF-10300KA	E7SF-10300LA	E7SF-10300MA
E7TF-10300BA	E7TF-10300LA	E7TF-10300MA	E7TF-10300SA	E7ZF-10300BA	E7ZF-10300DA
E7ZF-10300EA	E7ZF-10300FA	E87F-10300AA	E87F-10300BA	E87F-10300CA	E8EF-10300AB
E8HT-10300HA	E8PF-10346AA	E8PF-10346DA	E8PZ-10346A	E8PZ-10346C	E8SF-10300BA
E8TF-10300BA	E8TF-10300CA	E97F-10300AB	E97F-10300BA	E99F-10300	E99F-10300AB
E9DF-10300BB	E9EF-10300AA	E9EF-10300BA	E9PF-10346AB	E9PF-10346BA	E9PF-10346CB
E9PZ-10346A	E9PZ-10346B	E9PZ-10346C	E9PZ-10346D	E9SF-10300BA	E9UF-10300DA
F0EU-10300AA	F0PF-10346AA	F0PZ-10300F	F0PZ-10346E	F8PF-10346BA	F8PF-10346CB

**VR-F784M**

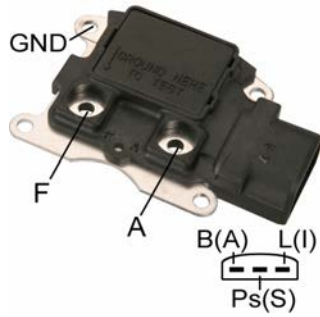

- \*Regitar No.:GR784M
- \*Short Circuit Protected
- \*For Use on: Ford 2G, 3G Alternators
- \*Voltage Set Point: 14.7V

**Replaces**

**FORD :**

E43F-10316AA    E43Z-10316A    E43Z-10316B    E63F-10316AA    E63F-10316AB    E6TZ-10316A

**Unit no.**

**FORD**

D53F-10300AA	D53F-10300BA	D53F-10300EA	D53F-10300FA	D53F-10300GA	D53F-10300HA
D53F-10346BA	D53F-10346DA	D53F-41300DA	E43F-10300PA	E43F-10300RA	E43F-10346B
E43F-10346BA	E43Z-10346D	E53Z-10346A	E57F-10300AA	E57F-10300BA	E59F-10300DA
E5TZ-10346A	E63F-10300AB	E63F-10300BB	E63F-10300CB	E63F-10300DA	E63F-10300EA
E63Z-10346A	E63Z-10346B	E65F-Z10346C	E67F-10300CA	E67F-10300DA	E67F-10300FA
E67F-10346AA	E67F-10346CA	E67Z-10346A	E69F-10300AA	E69F-10300BA	E69F-10346AA
E69F-10346BA	E6AF-10300AA	E6AF-10300BA	E6DF-10300BA	E6DF-10300DA	E6DF-10300EA
E6DF-10300EB	E6DF-10300GA	E6DF-10346A	E6DF-10346CA	E6DZ-10346B	E6DZ-10346C
E6EF-10300EA	E6EF-10300FA	E6EF-10300GA	E6EF-10300HA	E6EF-10300JA	E6EF-10346AA
E6EF-10346CA	E6FZ-10346A	E6SF-10300BA	E6TF-10300AA	E6TF-10300BA	E6TF-10300CA
E6TF-10300DA	E6TZ-10346A	E6TZ-10346B	E6TZ-10346C	E6UF-10300AA	E6ZF-10300CA
E6ZZ-10346B	E73F-10300BA	E73F-10300CA	E79F-10300BA	E7AF-10300DA	E7DF-10300GA
E7EF-10300CB	E7EF-10300DB	E7EF-10300EB	E7EF-10300FB	E7EF-10300GA	E7PF-10346AA
E7PF-10346BA	E7PF-10346CA	E7PF-10346DA	E7PF-10346FA	E7PF-10346GA	E7PF-10346KA
E7PF-10346LA	E7PF-10346MA	E7PF-10346NA	E7PF-10346UA	E7PF-10346XA	E7PZ-10346C
E7PZ-10346D	E7PZ-10346E	E7PZ-10346F	E7PZ-10346G	E7PZ-10346H	E7PZ-10346J
E7PZ-10346K	E7PZ-10346L	E7PZ-10346M	E7PZ-10346N	E7RY-10346A	E7SF-10300GA
E7SF-10300HA	E7SF-10300KA	E7SF-10300LA	E7SF-10300MA	E7TF-10300BA	E7TF-10300LA
E7TF-10300MA	E7TF-10300SA	E7ZF-10300BA	E7ZF-10300DA	E7ZF-10300EA	E7ZF-10300FA
E87F-10300AA	E87F-10300BA	E87F-10300CA	E8EF-10300AB	E8HT-10300HA	E8PF-10346AA
E8PF-10346CB	E8PF-10346DA	E8PZ-10346C	E8SF-10300BA	E8TF-10300BA	E8TF-10300CA
E97F-10300AB	E97F-10300BA	E991-0300	E99F-10300AB	E9DF-10300BB	E9EF-10300AA
E9EF-10300BA	E9PF-10346AB	E9PF-10346BA	E9PF-10346CB	E9PZ-10346A	E9PZ-10346B
E9PZ-10346C	E9PZ-10346D	E9SF-10300BA	E9UF-10300DA	F0EU-10300AA	F0PF-10346AA
F0PZ-10300F	F0PZ-10346E				

**VR-F786BH**

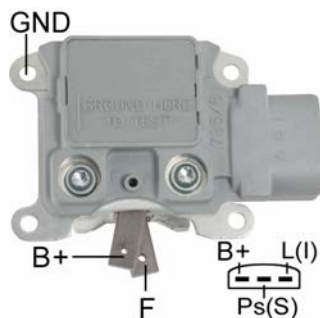

- \*With Brush Holder
- \*W/O LRC
- \*Voltage Set Point:14.45V

**Replaces**

**FORD :**

E0DZ-10316A    E9DF-10316AA

**MOTORCRAFT :**

GR801

**VR-F786H**

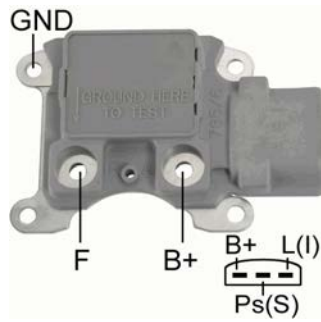

\*Regitar No.:GR786  
 \*For Use on: Ford 2G, 3G Alternators  
 \*Voltage Set Point:14.45V

**Replaces**

**FORD :**  
 E0DZ-10316A E9DF-10316AA  
**MOTORCRAFT :**  
 GR801

**Unit no.**

FORD					
F02Z-10346C	F07F-10300AA	F07U-10300AC	F09F-10300AA	F0CF-10300AA	F0CU-10300AA
F0CU-10300AB	F0CU-10300AC	F0CZ-10346A	F0CZ-10346C	F0DF-10300AA	F0DF-10300BA
F0DU-10300BB	F0DU-10300BC	F0DZ-10346A	F0DZ-10346B	F0DZ-10346C	F0DZ-10346D
F0PU-10346CA	F0PU-10346DA	F0PU-10346DD	F0PU-10346MC	F0PU-10346NC	F0PZ-10346A
F0VF-10300AA	F0VU-10300AA	F0VY-10346A	F0VY-10346B	F13U-10300AC	F13U-10300AD
F13Z-10346A	F1DU-10300AD	F1DU-10300AE	F1DZ-10346A	F1PU-10346AC	F1PU-10346BE
F1PU-1034BE	F1SU-10300AC	F1SU-10300AD	F1SZ-10346A	F1TZ-10346B	F1VU-10300BB
F1VU-10300BC	F1VY-10346A	F1VY-10346B	F2UZ-10346B		

**VR-F786HB**

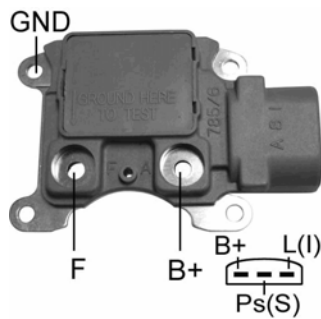

\*Short Circuit Protected  
 \*For Use on: Ford 2G, 3G 220A Alternators  
 \*Voltage Set Point: 14.45V

**VR-F786HC**

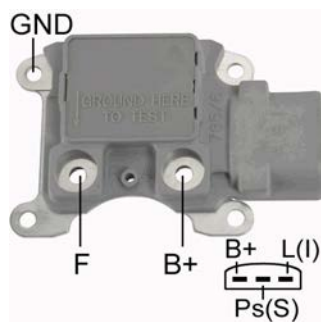

The VP4L2U-10316-AA Looks Like the Older F0DU-10316-AA, Except the Switching Speed of This Regulator is Faster. This Regulator Can Be Used in Place of the Older F0DU-10316-AA (8050-510), BUT Do NOT USE the 8050-510 to Replace the 8050-515.

**Replaces**

**FORD :**  
 VP4L2U-10316AA  
**MOTORCRAFT :**  
 GR801

**VR-F786M**

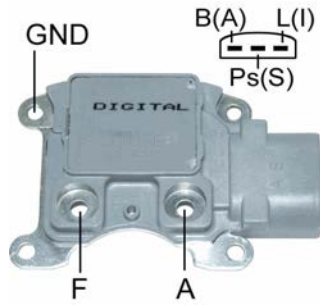

- \*Regitar No.:GR786M
- \*Short Circuit Protected
- \*For Use on: Ford 2G, 3G Alternators
- \*Voltage Set Point: 14.7V

**Replaces**

**FORD :**

E9DF-10316AA F0DZ-10316A

**MOTORCRAFT :**

GR801

**Unit no.**

FORD

F02Z-10346C	F07F-10300AA	F07U-10300AC	F09F-10300AA	F0CF-10300AA	F0CU-10300AA
F0CU-10300AB	F0CU-10300AC	F0CZ-10346A	F0CZ-10346C	F0DF-10300AA	F0DF-10300BA
F0DU-10300BB	F0DU-10300BC	F0DZ-10346A	F0DZ-10346B	F0DZ-10346C	F0DZ-10346D
F0PU-10346CA	F0PU-10346DA	F0PU-10346DD	F0PU-10346MC	F0PU-10346NC	F0PZ-10346A
F0VF-10300AA	F0VU-10300AA	F0VY-10346A	F0VY-10346B	F13U-10300AC	F13U-10300AD
F13Z-10346A	F1DU-10300AD	F1DU-10300AE	F1DZ-10346A	F1PI-1034BE	F1PU-10346AC
F1PU-10346BE	F1SU-10300AC	F1SU-10300AD	F1SZ-10346A	F1TZ-10346B	F1VU-10300BB
F1VU-10300BC	F1VY-10346A	F1VY-10346B	F2UZ-10346B		

**VR-F786SE**

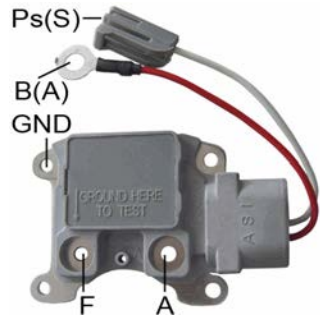

- \*Self Exciting
- \*Voltage Set Point: 14.6V

**Replaces**

**FORD :**

E0DZ-10316A E9DF-10316AA

**VR-F811**

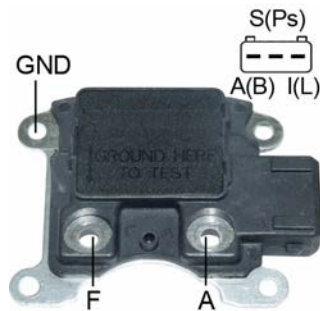

- \*Regitar No.:GR811
- \*For Use on: Ford 3G Alternators
- \*Voltage Set Point:14.7V

**Replaces**

**FORD :**

F3AZ-10316A F3AZ-10346A F3RU-10316AA GR811 F3AU-10316AA F3AZ-10316A

**MOTORCRAFT :**

GR811

**Unit no.**

FORD

F3AU-10300CA

**VR-F811BH**

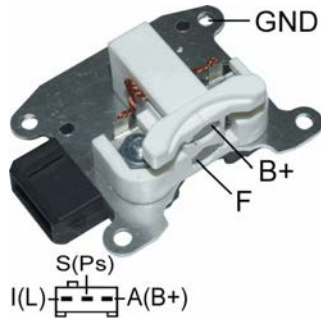

\*With Brush Holder  
 \*For Use on: Ford 3G Alternators  
 \*Voltage Set Point:14.7V

**Replaces**

**FORD :**  
 F3AZ-10316A    F3AZ-10346A    F3RU-10316AA

**Unit no.**

FORD  
 F3AU-10300CA

**VR-F814**

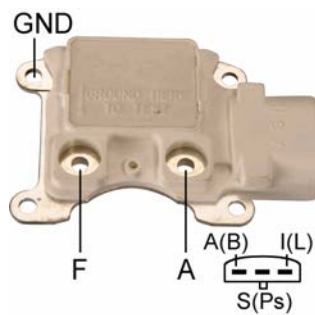

\*Regitar No.:GR814  
 \*Soft Start  
 \*10 Sec. LRC  
 \*For Use on: Ford 3G Alternators  
 \*Voltage Set Point:14.7V

**Replaces**

**FORD :**  
 F4ZZ-10316A  
**MOTORCRAFT :**  
 GR814

**Unit no.**

FORD  
 F4DU-10300CA    F4DU-10300DA    FD3U-10300CA    GL310

**VR-F815**

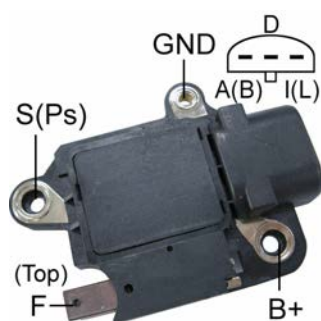

\*Regitar No.:GR815  
 \*Soft Start  
 \*10 Sec. LRC  
 \*For Use on: Ford 4G Alternators  
 \*Voltage Set Point:14.7V

**Replaces**

**FORD :**  
 F50U-100359AA    F50U-10316A    F50U-10C359AB  
**MOTORCRAFT :**  
 GR815

**Unit no.**

FORD  
 F5DU-10300DB    F50U-10300FA    F6DU-10300BB    F6DU-10300DB



**VR-F817**

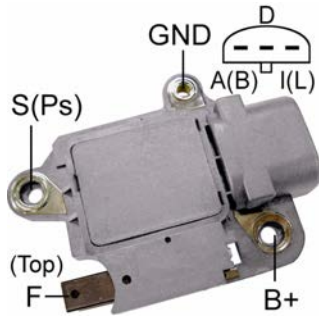

- \*Regitar No.: GR817
- \*For Use on: Ford 4G Alternators
- \*With Short Circuit Protected
- \*Voltage Set Point:14.7V

**Replaces**

**FORD :**  
 F6DU-10C359AA F6DY-10316A GR817

**Unit no.**

FORD  
 F6LU-10300CA F6ZU-10300BC F77U-10300AB

**VR-F818**

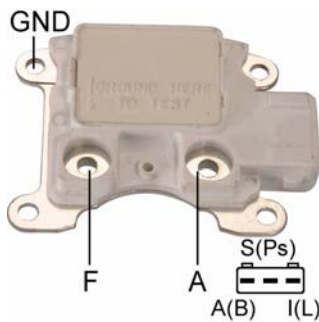

- \*Regitar No.:GR818
- \*Soft Start
- \*6 sec. LRC
- \*For Use on: 3G Alternators
- \*Voltage Set Point:14.5V

**Replaces**

**FORD :**  
 F4RU-10316AA F5RU-10316A F5RU-10316BA F5RZ-10316A  
**MOTORCRAFT :**  
 GR818 GR819

**Unit no.**

FORD  
 94BB-10300AE F4PU-10300AA F5RU-10300BA F6AZ-103004

**VR-F821**

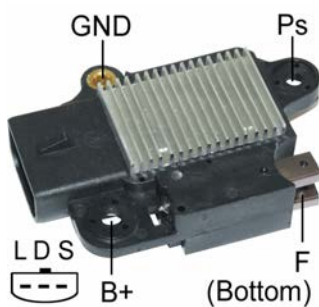

- \*Soft Start
- \*6 Sec. LRC
- \*Short Circuit Protected
- \*Voltage Set Point:14.4V
- \*Regitar No.: GR821

**Replaces**

**FORD :**  
 VP4L2U-10C359AA

**Unit no.**

FORD  
 6C2T-10300EB 6C2Z-10346EA

**VR-F822**

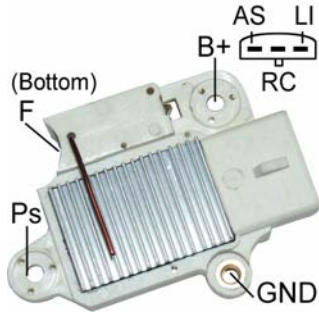

- \*Regitar No.:GR822
- \*Voltage Set Point:14.0V
- \*Regulated Voltage Control(RVC)
- \*Requires RVC01 tester box for testing

**Replaces**

**FORD :**  
VP6L8U-10C359AA

**VR-F900**

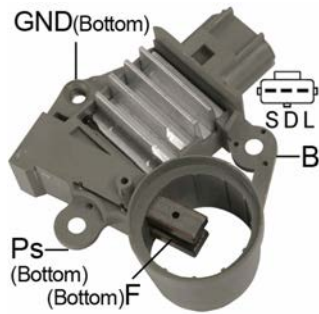

- \*Regitar No.:GR900
- \*L Terminal Does not Drive Choke
- \*Gray Cover
- \*Voltage Set Point:14.5V

**Replaces**

**FORD :**  
F8WU-10C359AB

**Unit no.**

FORD  
 F81U-10300BC    F81U-10300CC    F81U-10300DB    F81U-10300DC    F81U-10300EB    F81U-10300GA  
 F81Z-10346BA    F81Z-10346CA    F81Z-10346DA    F81Z-10346EA    F81Z-10346GA    XR3U-10300AA  
 XR3Z-10346AA

**VR-F901**

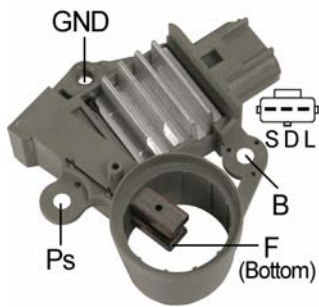

- \*Regitar No.: GR901
- \*Soft Start
- \*Short Circuit Protection
- \*w/green cover
- \*Voltage Set Point:14.2V

**Replaces**

**FORD :**  
VP3C3U-10C359AA

**Unit no.**

FORD  
 1R3U-10300AA    1R3U-10300AD    2C3U-10300BB    4C3T-10300AA    4C3T-10300BA

**VR-F910**

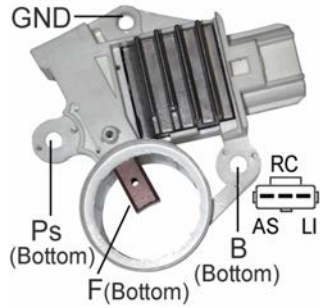

- \*A-Circuit
- \*w/gray cover
- \*Voltage Set Point: 14.3V
- \*Regulated Voltage Control(RVC)
- \*Requires RVC01 tester box for testing

**Replaces**

**FORD :**

VP4L3U-10C359AAVPF1U-10C359AA XW4U-10C359AB

**Unit no.**

FORD

1L8U-10300AB	1L8U-10300AC	1L8Z-10346AB	1S41-10300BB	3W1U-10300BB	3W1Z-10346BARM
98AB-10300EB	98AB-10300FC	98AZ-10346EA	98AZ-10346FA	GL456	GL462
XF2U-10300AB	XF2U-10300BC	XF2U-10300BD	XF2Z-10346AA	XF2Z-10346AARM	XF2Z-10346BA
XF2Z-10346BARM	XR8U-10300AE	XR8U-10300AF	XR8U-10300CE	XR8Z-10346AA	XR8Z-10346CE
XW4U-10300AA	XW4U-10300BA	XW4U-10300CC	XW4U-10300CD	XW4U-10300CE	XW4Z-10346AA
XW4Z-10346AARM	XW4Z-10346BA	XW4Z-10346BARM	XW4Z-10346CC	XW4Z-10346CCR	

**VR-F911**



- \*S-FR-L Terminals
- \*Soft Start
- \*8.5 Second LRC
- \*Short Circuit Protected
- \*Voltage Set Point: 14.5V

**Unit no.**

FORD

2C1T-10300BB 2T1U-10300CA 2T1U-10300CB YC1U-10300DA YC1U-10346DA

LUCAS

LRA2852

VISTEON

20-150-01009

**VR-F920**

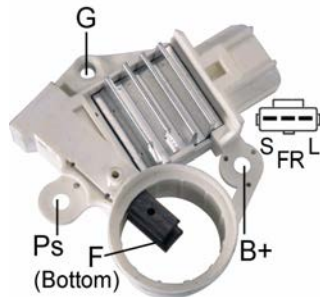

- \*Regitar No.:GR920
- \*w/white cover
- \*Voltage Set Point: 14.5V

**Replaces**

**FORD :**

XS7U-10C359AC

**Unit no.**

FORD

98BB-10300CC XS8Z-10346BB

**VR-F930**

\*Regitar No.:GR930  
 \*w/orange cover  
 \*Voltage Set Point:14.5V

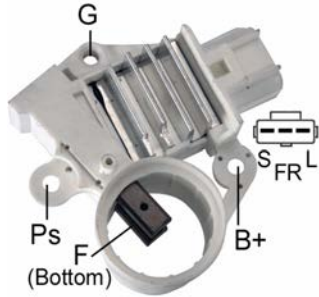

**Replaces**

**FORD :**  
 XS7U-10C359BA

**Unit no.**

FORD  
 1L8U-10300CD    1L8U-10300DD    1L8Z-10346CB    F8RZ-10346CC    GL419    GL431  
 GL463    XS8Z-10346BBRM    XS91-10300BB    XS91-10300BC

**VR-F931**

\*Regitar No.: GR931M  
 \*Voltage Set Point:14.4V



**Replaces**

**FORD :**  
 VP4L1U-10C359AA

**Unit no.**

FORD  
 3L7Z10346AA    3L7Z10346BA    GL550

**VR-H2001-1**

\*24V  
\*Voltage Set Point:28.3V

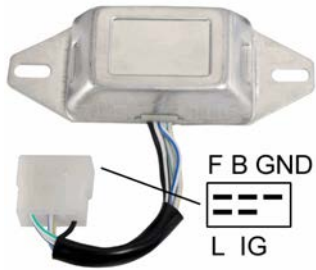

**Replaces**

HINO :  
27700-1480A    5140300610

**VR-H2001-2**

\*24V  
\*Voltage Set Point:28.3V



**Replaces**

HINO :  
27700-1210B    5140500411

**VR-H2001-3**

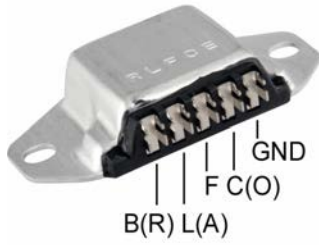

\*24V  
 \*R-L-F-C-E Terminals  
 \*Voltage Set Point:28.3V

**Replaces**

**HINO :**  
 27700-1370            27700-1510  
**KOMATSU :**  
 21J17  
**NISSAN :**  
 23500-99005  
**SAWAFUJI :**  
 1219-004-00            1219-005-00            1291-004-00X0  
**TOSHIBA :**  
 S5476A

**Unit no.**

<b>HINO</b>					
27040-1072	27040-1091	27040-1101	27040-1103	27040-1111	27040-1113
27040-1120	27040-1130	27040-1141	27040-1151	27040-1160	27040-1200
27040-1210	27040-1290	27040-1444	27050-1012	27050-1023	27050-1041
27050-1051	27050-1061	27050-1081	27050-1130	27050-1140	27050-1150
27050-1160					
<b>NISSAN</b>					
23100-96074	23100-96075	23100-96077	23100-96078	23100-96174	23100-96176
23100-96177	23100-96263	23100-96265	23100-97068	23100-97069	23100-97070
23100-97071	23100-97072	23100-97114	23100-97115	23100-97117	23100-97164
23100-97165					
<b>SAWAFUJI</b>					
0214-102-0011	0214-102-0021	0214-102-0213	0214-102-0214	0214-102-0410	0214-102-0420
0214-102-0511	0214-102-0611	0214-102-0711	0214-102-0813	0214-102-0911	0214-102-1011
0214-102-1013	0214-102-1111	0214-102-1113	0214-102-1210	0214-102-1220	0214-102-1230
0214-102-1310	0214-102-1320	0214-102-1330	0214-102-1410	0214-102-1420	0214-102-1510
0214-102-1611	0214-102-1711	0214-152-0011	0214-202-0030	0214-202-0110	0214-202-0210
0214-202-0220	0214-202-0230	0214-252-0011	0214-252-0020	0214-302-0010	0214-302-0040
0214-302-0050	0214-302-0110	0214-501-0010	0214-501-0110	0214-801-0110	

## VR-H2000-1



\*B-S-L-F-E Terminals  
 \*VR-H2000-1H(14V): Heavy Duty  
 \*VR-H2000-1L(Volts Setting: 14.4V)  
 \*Voltage Set Point:14.7V

### Replaces

#### BOSCH :

0-986-192-026      0-986-192-036

#### HITACHI :

TR1Z-27              TR1Z-33              TR1Z-47              TR1Z-48              TR1Z-56              TR1Z-65

#### LUCAS :

21511113

#### MAGNETI MARELLI :

940038078              940038089

#### NISSAN :

23215-B9800              23215-F2500              23215-P2500              23215-Q4601              23215-Q4602

#### SUBARU :

42990-7100              49575-7101              49575-7301

### Unit no.

#### HITACHI

LR135-44	LR135-61	LR135-61B	LR138-01	LR150-125	LR150-125B
LR150-194	LR150-194B	LR150-197	LR150-197B	LR150-30B	LR150-31
LR150-35	LR150-46	LR150-50	LR150-51	LR150-52	LR150-53
LR150-58	LR150-94B	LR150-98	LR150-98B	LR150-99	LR150-99B
LR155-15	LR155-15C	LR155-18	LR155-23	LR155-24	LR160-104
LR160-109	LR160-121	LR160-124	LR160-137	LR160-138	LR160-140
LR160-151	LR160-166	LR160-20	LR160-42	LR160-42B	LR160-46
LR160-47	LR160-57	LR160-61	LR160-62	LR160-74	LR160-75
LR160-78	LR160-78B	LR160-82	LR160-82B	LR160-84	LR160-84B
LR160-93	LR170-14	LR170-18	LR170-21	LR170-22	

#### NISSAN

23100-04M00	23100-10W01	23100-12G00	23100-20R00	23100-29R00	23100-37M00
23100-80W00	23100-84W00	23100-B9800	23100-B9801	23100-B9802	23100-B9805
23100-D0201	23100-D0800	23100-D1700	23100-D3300	23100-H7700	23100-H7701
23100-H7702	23100-H7703	23100-M5960	23100-M6601	23100-N8500	23100-P2506
23100-P3006	23100-Q4500	23100-V0100	23100-V0101	23100-V0102	23100-V0106
23100-V0107	23100-W2501	23100-W5801	23100-W5802	23100-W5803	23100-W5805
23100-W5806	23100-W5807				

#### SUBARU

23700-AA000	23700-AA020	42990-7320	42990-7330	42990-7340	42990-7400
42990-7600					

**VR-H2000-11**

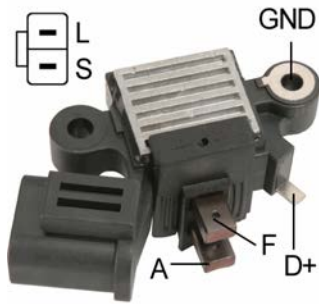

\*S-L Terminals  
\*Voltage Set Point:14.5V

**Replaces**

**HITACHI :**  
L170-43151  
**NISSAN :**  
23133-77A00

**Unit no.**

HITACHI  
LR165-707      LR165-707B      LR170-707B      LR175-707      LR175-7070  
NISSAN  
23100-77A00

**VR-H2000-12**



\*S-IG-L Terminals  
\*Repair Circuit: VR-H2000-9S  
\*Voltage Set Point:14.5V

**Replaces**

**ISUZU :**  
8-94249-860-0  
**LUCAS :**  
21511109      UCJ126

**Unit no.**

HITACHI  
LR150-703  
ISUZU  
8-94413-621-0



**VR-H2000-13**



\*S-L Terminals  
 \*Repair Circuit: VR-H2000-13S  
 \*Voltage Set Point:14.5V

**Replaces**

**HITACHI :**  
 L170-6315

**Unit no.**

HITACHI  
 LR160-703            LR170-706  
 SUBARU  
 9202-0644

**VR-H2000-14**

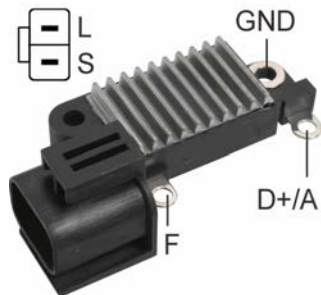

\*S-L Terminals  
 \*Repair Circuit: VR-H2000-14S  
 \*Voltage Set Point:14.5V

**Replaces**

**HITACHI :**  
 L170-33152  
**NISSAN :**  
 23215-50Y05

**Unit no.**

HITACHI  
 LR165-708B            LR170-738            LR170-738B            LR180-730  
 NISSAN  
 23100-50Y05            23100-50Y07            23100-OE700            23100-OE705

**VR-H2000-15**



\*S-IG-D-L Terminals  
 \*Repair Circuit: VR-H2000-15S  
 \*Voltage Set Point:14.5V

**Replaces**

**HITACHI :**

L170-23152

**SUBARU :**

23815-AA010

**Unit no.**

HITACHI

LR170-732B

LR170-732C

SUBARU

23700-AA090

**VR-H2000-16**

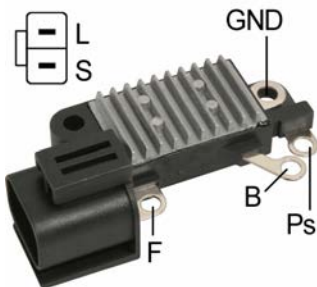

\*S-L Terminals  
 \*Similar to VR-H2000-14, but with Stator Terminal  
 \*Repair Circuit: VR-H2000-23S  
 \*Voltage Set Point:14.5V

**Replaces**

**HITACHI :**

L180G-2340

L165G-2315

L180G-6340

L180G-7340

**NISSAN :**

23215-0C001

23215-70T00

23215-85L00

**Unit no.**

HITACHI

LR165-708C

LR170-738C

LR170-744

LR180-7035

LR180-731B

LR190-715B

NISSAN

23100-0C000

23100-0E700

23100-0E705

23100-85L00

23100-86L00

**VR-H2000-17**

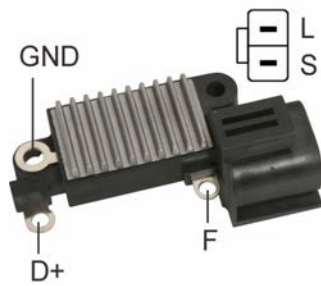

\*S-L Terminals  
 \*Repair Circuit: VR-H2000-17S  
 \*Voltage Set Point:14.5V

**Replaces**

**HITACHI :**  
 L180-8315

**NISSAN :**  
 23215-64J00

**Unit no.**

HITACHI					
LR160-723	LR160-723B	LR170-734	LR170-734B	LR170-739	LR180-725
LR180-729	LR180-736B				
NISSAN					
23100-12G02	23100-64J00	23100-80G08	23100-88G00		

**VR-H2000-18**



\*S-L Terminals  
 \*Repair Circuit: VR-H2000-18S  
 \*Voltage Set Point:14.5V

**Replaces**

**HITACHI :**  
 L180-5340      L180G-9340

**NISSAN :**  
 23215-64J01      23215-64J00      23215-64J02

**Unit no.**

HITACHI					
LR160-724	LR170-739B	LR180-725	LR180-725B	LR180-725C	LR180-725E
LR180-734B	LR180-734C	LR180-736B	LR190-719		
NISSAN					
23100-64J01					

**VR-H2000-19**

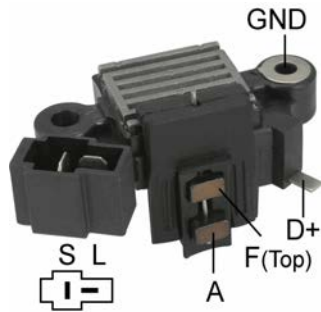

\*S-L Terminals  
\*Voltage Set Point:14.5V

**Replaces**

**HITACHI :**

L165-5315

**SUBARU :**

23733-A0010      23733-AA010

**Unit no.**

HITACHI

LR165-704B      LR165-705

SUBARU

23700-AA150

**VR-H2000-1H**



\*Heavy Duty  
\*Voltage Set Point:14.4V

**Replaces**

**BOSCH :**

0-986-192-026      0-986-192-036

**HITACHI :**

TR1Z-27      TR1Z-33      TR1Z-47      TR1Z-48      TR1Z-56      TR1Z-65

**NISSAN :**

23215-B9800      23215-F2500      23215-P2500      23215-Q4601      23215-Q4602

**SUBARU :**

42990-7100      49575-7101      49575-7301

**Unit no.**

HITACHI

LR135-44	LR135-61	LR135-61B	LR138-01	LR150-125	LR150-125B
LR150-194	LR150-194B	LR150-197	LR150-197B	LR150-30B	LR150-31
LR150-35	LR150-46	LR150-50	LR150-51	LR150-52	LR150-53
LR150-58	LR150-94B	LR150-98	LR150-98B	LR150-99	LR150-99B
LR155-15	LR155-15C	LR155-18	LR155-23	LR155-24	LR160-104
LR160-109	LR160-121	LR160-124	LR160-137	LR160-138	LR160-140
LR160-151	LR160-166	LR160-20	LR160-42	LR160-42B	LR160-46
LR160-47	LR160-57	LR160-61	LR160-62	LR160-74	LR160-75
LR160-78	LR160-78B	LR160-82	LR160-82B	LR160-84	LR160-84B
LR160-93	LR170-14	LR170-18	LR170-21	LR170-22	

**VR-H2000-1L**

\*Voltage Setting: 14.4V



**Replaces**

**BOSCH :**

0-986-192-026      0-986-192-036

**HITACHI :**

TR1Z-27              TR1Z-33              TR1Z-47              TR1Z-48              TR1Z-56              TR1Z-65

**NISSAN :**

23215-B9800      23215-F2500      23215-P2500      23215-Q4601      23215-Q4602

**SUBARU :**

42990-7100      49575-7101      49575-7301

**VR-H2000-2**

\*R-R-L-F-E Terminals  
\*Voltage Set Point:14.5V



**Replaces**

**HITACHI :**

TR1Z-44              TR1Z-63

**ISEKI :**

6581-270-004-0

**ISUZU :**

5-81270-004-0

**SUBARU :**

49575-5601

**YANMAR :**

0124080-77390      XTR1Z-44              XTR1Z-63

**Unit no.**

**HITACHI**

LR120-15C      LR120-23      LR135-105      LR135-115      LR135-116      LR135-58B

LR135-86F      LR135-95      LR155-01      LR155-20

**ISEKI**

581-200-338-0      581-200-338-1      581-200-349-0      581-200-358-0

**ISUZU**

5-00181-010-0      5-81200-338-0      5-81200-341-0      5-81200-349-0      5-81200-358-0

**YANMAR**

0121400-77201      128270-77200      129772-77200      129795-77200

**VR-H2000-20**

\*S-L Terminals  
\*Voltage Set Point:14.5V

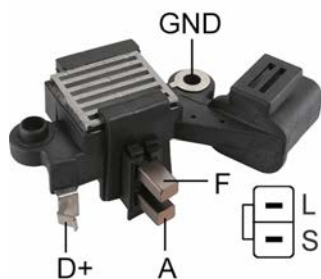

**Replaces**

**HITACHI :**  
L190-4315

**NISSAN :**  
23133-F6500

**Unit no.**

HITACHI

LR170-710B	LR180-705B	LR180-708	LR180-710B	LR180-724	LR190-706
------------	------------	-----------	------------	-----------	-----------

LR190-707	LR190-707B	LR190-714			
-----------	------------	-----------	--	--	--

NISSAN

23100-16N00	23100-30P00	23100-59S01	23100-F6501		
-------------	-------------	-------------	-------------	--	--

**VR-H2000-21**

\*S-L Terminals  
\*Repair Circuit: VR-H2000-10S  
\*Voltage Set Point:14.5V

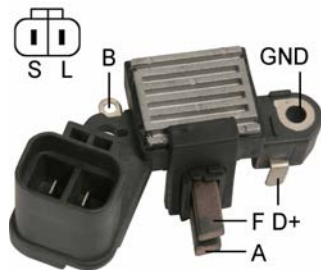

**Replaces**

**HITACHI :**  
L170-3315

**NISSAN :**  
23133-13E00

**Unit no.**

HITACHI

LR160-708	LR160-709	LR160-710
-----------	-----------	-----------

NISSAN

23100-02E00	23100-02E05
-------------	-------------

**VR-H2000-23**

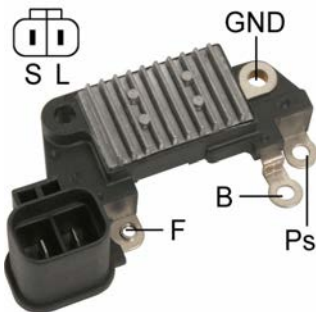

\*S-L Terminals  
\*Voltage Set Point:14.5V

**Replaces**

**HITACHI :**  
L195G-2340  
**NISSAN :**  
23215-97E01

**Unit no.**

HITACHI  
LR195-701  
NISSAN  
23100-97E01

**VR-H2000-24**



\*S-IG-L Terminals  
\*Voltage Set Point:14.5V

**Unit no.**

HITACHI  
LR150-711      LR160-725      LR160-726

**VR-H2000-26**

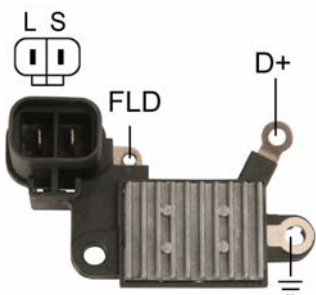

\*S-L Terminals  
\*Voltage Set Point:14.5V

**Replaces**

**HITACHI :**  
L1110-2315

**Unit no.**

NISSAN  
23100-60U00

## VR-H2000-27



\*Repair Circuit:VR-H2000-28S  
 \*S-L Terminals  
 \*Voltage Set Point:14.5V

### Replaces

**HITACHI :**  
 L185G-4340  
**SUBARU :**  
 23815-AA050

### Unit no.

HITACHI  
 LR190-724  
 NISSAN  
 23100-70F05

## VR-H2000-28

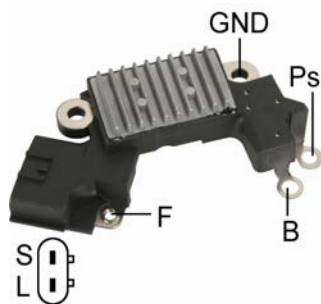

\*S-L Terminals  
 \*Short Circuit Protection  
 \*Repair Circuit:VR-H2000-28S  
 \*Voltage Set Point:14.5V

### Replaces

**HITACHI :**  
 L1100G-3340      L1100G-9340  
**NISSAN :**  
 23215-31U05

### Unit no.

HITACHI  
 LR1110-705  
 NISSAN  
 23100-31U01      23100-31U02



**VR-H2000-29**

\*IG-L-S Terminals  
\*Voltage Set Point:14.5V



**Replaces**

**GM :**

94167410

**HITACHI :**

L150-33155

**ISUZU :**

8-94167-410-0

**VALEO :**

A556536A

**Unit no.**

**HITACHI**

LR150-415	LR150-421C	LR150-431	LR150-432	LR150-434B	LR150-438B
LR150-439B	LR155-416	LR155-418B	LR155-419B	LR160-419	LR160-432B
LR160-433B	LR160-433E	LR160-434B	LR160-435E	LR160-443	LR160-444
LR160-444B	LR160-446				

**ISUZU**

8-94122-488-4	8-94128-056-2	8-94171-674-0	8-94419-519-1	8-94428-885-3	8-94428-886-1
8-94428-887-3	8-94441-959-1	8-94449-054-2	8-94452-134-1	8-94452-739-0	8-94452-739-2
8-94452-740-1	8-94452-740-3	8-94490-540	8-97037-724-1	8-97039-342-0	8-97043-566-0
8-97074-611-0					

**VR-H2000-29A-2**

\*IG-L-S Terminals  
\*Voltage Set Point:14.5V  
\*With Capacitor



**Replaces**

**GM :**

94167410

**HITACHI :**

L150-33155

**ISUZU :**

8-94167-410-0

**VALEO :**

A556536A

**Unit no.**

**HITACHI**

LR150-415	LR150-421C	LR150-431	LR150-432	LR150-434B	LR150-438B
LR150-439B	LR155-416	LR155-418B	LR155-419B	LR160-419	LR160-432B
LR160-433B	LR160-433E	LR160-434B	LR160-435E	LR160-443	LR160-444
LR160-444B	LR160-446				

**ISUZU**

8-94122-488-4	8-94128-056-2	8-94171-674-0	8-94419-519-1	8-94428-885-3	8-94428-886-1
8-94428-887-3	8-94441-959-1	8-94449-054-2	8-94452-134-1	8-94452-739-0	8-94452-739-2
8-94452-740-1	8-94452-740-3	8-94490-540	8-97037-724-1	8-97039-342-0	8-97043-566-0
8-97074-611-0					

**VR-H2000-29B**



\*24V  
 \*IG-L-S Terminals  
 \*Voltage Set Point:28.3V

**Replaces**

**HITACHI :**  
 TR2Z-49                    L225-8315

**ISUZU :**  
 8-94156590-0

**NISSAN :**  
 23215-C6800

**Unit no.**

HITACHI  
 LR270-05  
 NISSAN  
 23100-17D60

**VR-H2000-29BA-2**



\*24V  
 \*IG-L-S Terminals  
 \*Voltage Set Point:28.3V  
 \*With Capacitor

**Replaces**

**HITACHI :**  
 TR2Z-49                    L225-8315

**ISUZU :**  
 8-94156590-0

**NISSAN :**  
 23215-C6800

**Unit no.**

HITACHI  
 LR270-05  
 NISSAN  
 23100-17D60

**VR-H2000-29BC**



\*24V  
 \*IG-L-S Terminals  
 \*W/ integral design frame  
 \*Voltage Set Point:28.3V

**Replaces**

**HITACHI :**  
 TR2Z-49                    L225-8315  
**ISUZU :**  
 8-94156590-0  
**NISSAN :**  
 23215-C6800

**Unit no.**

HITACHI  
 LR270-05  
 NISSAN  
 23100-17D60

**VR-H2000-29C**



\*IG-L-S Terminals  
 \*W/ integral design frame  
 \*Voltage Set Point:14.5V

**Replaces**

**GENERAL MOTORS :**  
 94167410  
**GM :**  
 94167410  
**HITACHI :**  
 L150-33155  
**ISUZU :**  
 8-94167-410-0  
**VALEO :**  
 A556536A

**Unit no.**

HITACHI					
LR150-415	LR150-421C	LR150-431	LR150-432	LR150-434B	LR150-438B
LR150-439B	LR155-416	LR155-418B	LR155-419B	LR160-419	LR160-432B
LR160-433B	LR160-433E	LR160-434B	LR160-435E	LR160-443	LR160-444
LR160-444B	LR160-446				
ISUZU					
8-94122-488-4	8-94128-056-2	8-94171-674-0	8-94419-519-1	8-94428-885-3	8-94428-886-1
8-94428-887-3	8-94441-959-1	8-94449-054-2	8-94452-134-1	8-94452-739-0	8-94452-739-2
8-94452-740-1	8-94452-740-3	8-94490-540	8-97037-724-1	8-97039-342-0	8-97043-566-0
8-97074-611-0					

**VR-H2000-2B**



- \*24V
- \*R-R-L-F-E Terminals
- \*Active lamp
- \*Voltage Set Point:28.3V

**Replaces**

**HITACHI :**

TR2Z-47

**ISUZU :**

5-81251-016-0

**NISSAN :**

23500-99008

**YANMAR :**

119129-77820

**Unit no.**

HITACHI

LR215-50	LR220-23	LR220-24	LR225-84T	LR225-85	LR225-86B
LR225-89	LR235-61C	LR235-62	LR235-65	LR235-68	LR235-69
LR235-72B	LR235-76	LR235-80	LR240-19C	LR240-20C	LR240-21
LR240-22E	LR240-25	LR240-26	LR240-29B	LR240-31E	LR240-32

ISUZU

1-81200-393-1	1-81200-401-0	5-81200-330-0	5-81200-335-0	8-94431-560-0	
---------------	---------------	---------------	---------------	---------------	--

NISSAN

23099-Z5518	23099-Z5560	23099-Z5561	23099-Z5562	23100-51H00	23100-95014
23100-96279	23100-96515	23100-96516	23100-97170	23100-97171	23100-K6701
23100-Z5519	23100-Z5563	23100-Z5605	23100-Z5606		

YANMAR

119129-77201	129535-77200
--------------	--------------

## VR-H2000-3



\*B-S-R-L-F-E Terminals  
\*Voltage Set Point:14.5V

### Replaces

#### BOSCH :

0-986-192-030

#### DELCO REMY (LUCAS) :

21511114

#### HITACHI :

136284

TR1Z-43

TR1Z-53

TR1Z-62

TR1Z-64

#### ISUZU :

8-94237-720-0

8-94250-964-0

8-94250-968-0

#### MAZDA :

RF01-24-520

S208-24-520

#### NISSAN :

23215-54A00

23215-W1700

23215-W1701

### Unit no.

#### HITACHI

LR140-130B

LR140-130P

LR140-131

LR140-131B

LR140-138

LR150-133

LR150-133B

LR150-133C

LR150-133E

LR150-146

LR150-146B

LR150-146C

LR150-155B

LR150-205

LR150-205B

LR150-402

LR150-402C

LR150-403

LR150-436

LR150-55B

LR155-12C

LR155-16

LR155-16B

LR160-107B

LR160-108B

LR160-144

LR160-146B

LR160-147F

LR160-148F

LR160-152F

LR160-164

LR160-401

LR160-401C

LR160-422B

LR160-67H

LR160-92C

LR160-96

LR160-96B

LR160-96C

LR160-96H

LR160-97

LR160-97B

LR160-97C

LR170-401

LR170-404

LR170-410

#### ISUZU

8-94155-308-5

8-94155-309-5

8-94234-987-2

8-94234-987-3

8-94238-453-2

8-94246-956-0

8-94246-956-1

8-94246-957-0

8-94246-957-1

8-94401-793-0

8-94401-793-2

8-94407-184-0

8-94408-365-0

8-94408-918-4

#### NISSAN

23099-29W00

23099-36W01

23099-36W02

23099-36W04

23099-R8103

23099-R8104

23099-R8109

23099-W1705

23100-10G03

23100-11H00

23100-17A00

23100-17A01

23100-17C00

23100-18A00

23100-18A01

23100-54A01

23100-G3706

23100-M5201

23100-W1806

23100-W1807

23100-W2500

23100-W2501

23100-W2502

23100-W3405

23100-W5800

## VR-H2000-30

\*S-L Terminals  
\*Voltage Set Point:14.5V

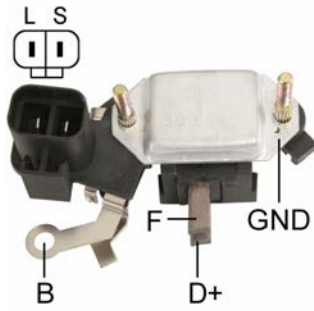

### Replaces

#### HITACHI :

L150-93155      L160-63153

#### NISSAN :

23528-18G01      23528-V7200

### Unit no.

#### HITACHI

LR140-415B	LR140-419	LR140-419T	LR140-421	LR140-421T	LR140-422T
LR150-425B	LR150-428S	LR150-428T	LR150-430S	LR150-435S	LR150-435T
LR150-443S	LR160-417	LR160-421C	LR160-421F	LR160-422B	LR160-426S
LR160-426T	LR160-427S	LR160-427T	LR160-436S	LR160-437S	LR170-406B
LR170-406E	LR170-406F	LR170-407S	LR170-407T	LR170-408S	LR170-412S
LR170-412T	LR170-413	LR170-414B	LR170-414E	LRT150-430T	

#### NISSAN

23100-02N20	23100-11T16	23100-43G08	23100-44G02	23100-56C01
-------------	-------------	-------------	-------------	-------------

## VR-H2000-31

\*S-L Terminals  
\*Voltage Set Point:14.7V

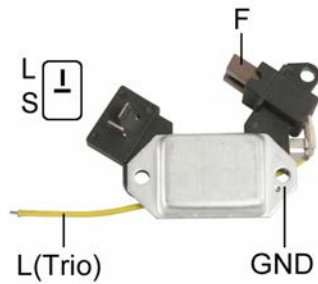

### Replaces

#### BOSCH :

0-986-192-026      0-986-192-036

#### HITACHI :

TR1Z-27	TR1Z-28	TR1Z-33	TR1Z-47	TR1Z-48	TR1Z-56
TR1Z-65					

#### LUCAS :

21511113

#### MAGNETI MARELLI :

940038078      940038089

#### NISSAN :

23215-B9800	23215-F2500	23215-P2500	23215-Q4601	23215-Q4602
-------------	-------------	-------------	-------------	-------------

#### SUBARU :

42990-7100	49575-7101	49575-7301
------------	------------	------------

### Unit no.

#### HITACHI

LR135-44	LR135-61	LR135-61B	LR138-01	LR150-125	LR150-125B
LR150-194	LR150-194B	LR150-197	LR150-197B	LR150-30B	LR150-31
LR150-35	LR150-46	LR150-50	LR150-51	LR150-52	LR150-53
LR150-58	LR150-94B	LR150-98	LR150-98B	LR150-99	LR150-99B
LR155-15	LR155-15C	LR155-18	LR155-23	LR155-24	LR160-104
LR160-109	LR160-121	LR160-124	LR160-137	LR160-138	LR160-140
LR160-151	LR160-166	LR160-20	LR160-42	LR160-42B	LR160-46
LR160-47	LR160-57	LR160-61	LR160-62	LR160-74	LR160-75
LR160-78	LR160-78B	LR160-82	LR160-82B	LR160-84	LR160-93
LR170-14	LR170-18	LR170-21			

#### NISSAN

23100-04M00	23100-10W01	23100-12G00	23100-20R00	23100-29R00	23100-37M00
23100-80W00	23100-84W00	23100-B9800	23100-B9801	23100-B9802	23100-B9805
23100-D0201	23100-D0800	23100-D1700	23100-D3300	23100-H7700	23100-H7701
23100-H7702	23100-H7703	23100-M5960	23100-M6601	23100-N8500	23100-P2506
23100-P3006	23100-Q4500	23100-V0100	23100-V0101	23100-V0102	23100-V0106
23100-V0107	23100-W2501	23100-W5801	23100-W5802	23100-W5803	23100-W5805
23100-W5806	23100-W5807				

#### SUBARU

23700-AA000	23700-AA020	42990-7320	42990-7330	42990-7340	42990-7400
42990-7600					

## VR-H2000-32

\*S-L Terminals  
\*Voltage Set Point:14.7V

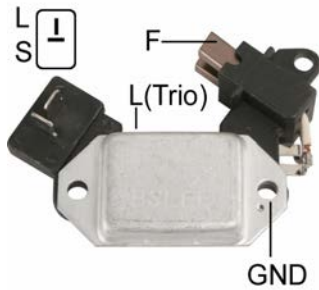

### Replaces

#### BOSCH :

0-986-192-026      0-986-192-036

#### HITACHI :

TR1Z-27	TR1Z-28	TR1Z-33	TR1Z-47	TR1Z-48	TR1Z-56
TR1Z-65					

#### LUCAS :

21511113

#### MAGNETI MARELLI :

940038078      940038089

#### NISSAN :

23215-B9800	23215-F2500	23215-P2500	23215-Q4601	23215-Q4602
-------------	-------------	-------------	-------------	-------------

#### SUBARU :

42990-7100	49575-7101	49575-7301
------------	------------	------------

### Unit no.

#### HITACHI

LR135-44	LR135-61	LR135-61B	LR138-01	LR150-125	LR150-125B
LR150-194	LR150-194B	LR150-197	LR150-197B	LR150-30B	LR150-31
LR150-35	LR150-46	LR150-50	LR150-51	LR150-52	LR150-53
LR150-58	LR150-94B	LR150-98	LR150-98B	LR150-99	LR150-99B
LR155-15	LR155-15C	LR155-18	LR155-23	LR155-24	LR160-104
LR160-109	LR160-121	LR160-124	LR160-137	LR160-138	LR160-140
LR160-151	LR160-166	LR160-20	LR160-42	LR160-42B	LR160-46
LR160-47	LR160-57	LR160-61	LR160-62	LR160-74	LR160-75
LR160-78	LR160-78B	LR160-82	LR160-82B	LR160-84	LR160-84B
LR160-93	LR170-14	LR170-18	LR170-21	LR170-22	

#### NISSAN

23100-04M00	23100-10W01	23100-12G00	23100-20R00	23100-29R00	23100-37M00
23100-80W00	23100-84W00	23100-B9800	23100-B9801	23100-B9802	23100-B9805
23100-D0201	23100-D0800	23100-D1700	23100-D3300	23100-H7700	23100-H7701
23100-H7702	23100-H7703	23100-M5960	23100-M6601	23100-N8500	23100-P2506
23100-P3006	23100-Q4500	23100-V0100	23100-V0101	23100-V0102	23100-V0106
23100-V0107	23100-W2501	23100-W5801	23100-W5802	23100-W5803	23100-W5805
23100-W5806	23100-W5807				

#### SUBARU

23700-AA000	23700-AA020	42990-7320	42990-7330	42990-7340	42990-7400
42990-7600					



**VR-H2000-33**

\*Voltage Set Point:14.5V

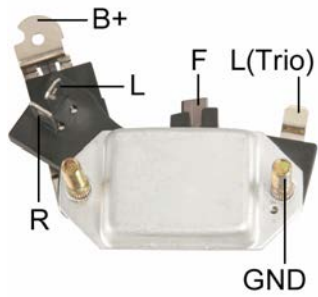

**Replaces**

**HITACHI :**  
L135-13152

**Unit no.**

HITACHI  
LR135-105      LR135-106      LR135-126

**VR-H2000-34**

\*Voltage Set Point:14.5V

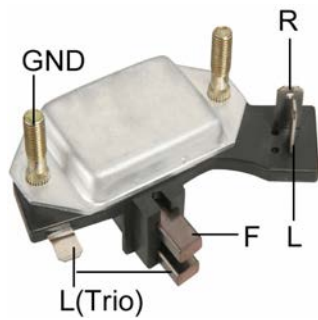

**Replaces**

**HITACHI :**  
L135-43153

**Unit no.**

HITACHI  
LR120-23      LR135-104      LR135-125      LR135-127      LR135-128      LR135-86F  
LR135-91      LR135-95

**VR-H2000-35**

\*Voltage Set Point:14.5V

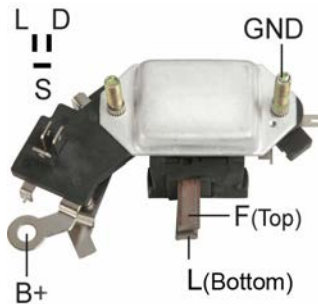

**Replaces**

**HITACHI :**  
L150-23155  
**NISSAN :**  
23528-29W00

**Unit no.**

HITACHI  
LR155-16P      LR155-408

**VR-H2000-36**

\*Voltage Set Point:14.5V

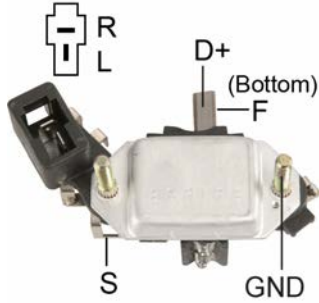

**Replaces**

**HITACHI :**  
L150-73154

**Unit no.**

HITACHI  
LR140-406      LR140-410F      LR140-423F      LR150-410F

**VR-H2000-37**

\*Voltage Set Point:14.7V

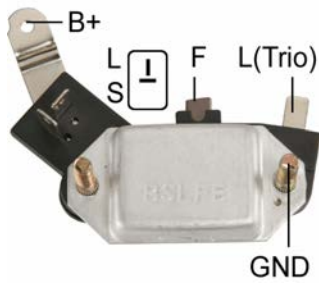

**Replaces**

**BOSCH :**  
0-986-192-028

**HITACHI :**  
L150-43151      L150-63151

**NISSAN :**  
23133-D0200      23133-Q4601      23133-W1606      23133-W7101

**Unit no.**

HITACHI  
LR150-100      LR150-101B      LR150-125B      LR150-132B      LR150-98E      LR150-99B  
LR160-105      LR160-109C      LR160-130      LR160-77      LR160-79      LR160-85B  
LR170-10  
NISSAN  
23100-01N06      23100-27G00

**VR-H2000-38**



\*Repair Circuit:VR-H2000-38S  
 \*W/o Overvoltage/Undervoltage indication  
 \*W/o Short Circuit Protection  
 \*Voltage Set Point:14.5V

**Replaces**

**HITACHI :**  
 L170G-6315      L180G-23401  
**NISSAN :**  
 23215-0W401      22020-85M10      23215-0M801

**Unit no.**

HITACHI  
 LR165-711      LR165-711B      LR170-743      LR170-745      LR170-745B      LR170-746E  
 LR170-746F      LR170-746G      LR170-746J      LR170-750C      LR170-750E      LR170-752  
 LR170-752B      LR180-741B      LR190-432      LR190-725B      LR190-725E

**VR-H2000-38SC**



\*Repair Circuit:VR-H2000-38SCS  
 \*Overvoltage/Undervoltage indication  
 \*Short Circuit Protection  
 \*Voltage Set Point:14.5V

**VR-H2000-39**



\*S-L Terminals  
 \*Soft Start  
 \*2.5 sec. LRC  
 \*Voltage Set Point:14.5V

**Replaces**

**HITACHI :**  
 TR1Z-108      TR1Z-108B

**Unit no.**

HITACHI  
 LR170-501C      LR170-502B      LR170-502C      LR170-503      LR170-504      LR170-504B  
 LR190-504C      LR190-505C      LR190-505E      LR190-511      LR190-511B      LR190-512  
 LR190-512B      LR190-512C      LR190-515      LR190-515B

**VR-H2000-3A**



\*24V  
 \*B-S-R-L-F-E Terminals  
 \*Voltage Set Point:28.3V

**Replaces**

**HITACHI :**

TR2Z-37                      TR2Z-49

**ISUZU :**

8-94156-595-0

**NISSAN :**

23215-C6800

**Unit no.**

HITACHI

LR225-403	LR225-407	LR225-408E	LR225-409B	LR225-410	LR225-412T
LR225-413T	LR225-414T	LR225-415B	LR225-418B	LR225-65P	LR225-67P
LR225-68B	LR225-80B	LR235-401	LR235-402	LR235-403T	LR235-404T
LR235-405T	LR235-406	LR235-58	LR235-70B	LR235-75C	LR235-78
LR240-34	LR240-35	LR240-401	LR240-402	LR240-404C	LR260-18B
LR260-20C	LR270-02B	LR270-03C			

ISUZU

8-94122-267-3	8-94336-728-0	8-94342-524-0	8-94389-772-1	8-94404-652-0	8-94472-330-0
8-94473-148-0	8-97013-172-2				

NISSAN

23099-C6808	23099-C8600	23099-R8111	23099-R8702	23099-S9000	23099-T9004
23100-03T03	23100-03T04	23100-04D10	23100-04D11	23100-10T06	23100-10T07
23100-11T14	23100-11T15	23100-34T04	23100-34T05	23100-C8602	23100-C8604

**VR-H2000-40**

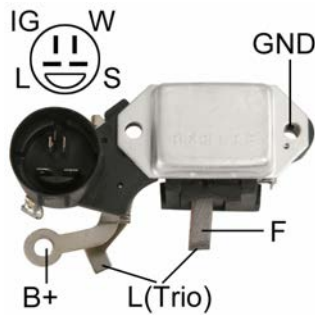

\*Without capacitor  
 \*Voltage Set Point:14.5V

**Replaces**

**HITACHI :**

L170G-1315

**Unit no.**

HITACHI

LR170-420

**VR-H2000-41**

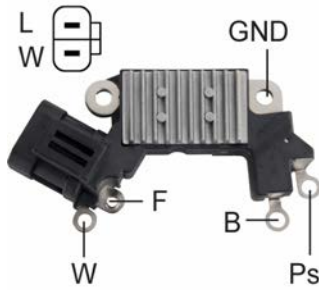

\*L-W Terminals  
 \*Repair Circuit:VR-H2000-41S  
 \*Voltage Set Point:14.5V

**Replaces**

**HITACHI :**  
 L170G-3319      L170G-6308      L170G-7315

**VR-H2000-42**



\*L-S Terminals  
 \*Same as VR-H2000-38 but W/Brush Holder  
 \*Voltage Set Point:14.5V

**Replaces**

**HITACHI :**  
 L170G-6315      L180G-23401      L190G-7340  
**NISSAN :**  
 23215-5V100      22020-85M10      23215-0M810

**Unit no.**

HITACHI  
 LR165-711      LR165-711B      LR170-743      LR170-745,B      LR170-746E      LR170-746F  
 LR170-746G      LR170-746J      LR170-750C,E      LR170-752,B      LR180-741      LR190-725B,E  
 LR190-732

**VR-H2000-43**



\*L-S Terminals  
 \*Soft Start  
 \*4.5 sec. LRC  
 \*Short Circuit Protection  
 \*Voltage Set Point:14.2V

**Replaces**

**HITACHI :**  
 L190G-5340  
**NISSAN :**  
 23215-0W402

**Unit no.**

HITACHI  
 LR180-751      LR190729      LR190737      LR190737E  
 NISSAN  
 23100-0W000      23100-0W001      23100-0W002      23100-0W004      23100-3M200

**VR-H2000-44**

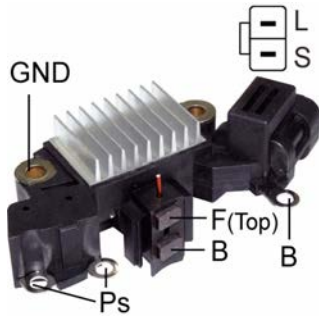

- \*L-S Terminals
- \*Repair Circuit: VR-H2000-44S
- \*2.5 sec. LRC
- \*Short Circuit Protection
- \*Voltage Set Point:14.5V

Unit no.

HITACHI  
 LR1100-722      LR180-756B  
 NISSAN  
 23100-3S500      23100-4S100      23100-9E000

**VR-H2000-45**

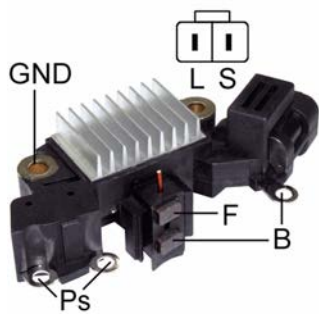

- \*L-S Terminals
- \*Same as VR-H2000-44 but LRC=8.5sec
- \*For use on NISSAN SENTRA 180
- \*Voltage Set Point:14.5V

Unit no.

HITACHI  
 LR180-769  
 NISSAN  
 21300-4Z400

**VR-H2000-46**

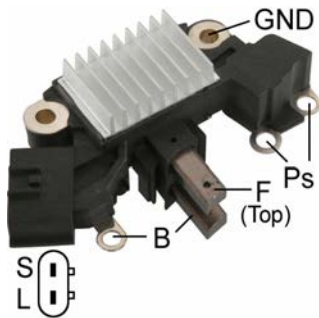

- \*S-L Terminals
- \*Inactive Lamp
- \*Soft Start
- \*8.5 sec. LRC
- \*Short Circuit Protection
- \*Voltage Set Point:14.5V

Replaces

**HITACHI :**  
 L1100G-53402      L1100G-8340      L1110G-43402  
**NISSAN :**  
 23100-2Y000      23215-2Y005      23215-0L701      23215-2Y001

Unit no.

HITACHI  
 LR1100-711B      LR1110-707G      LR1110-709B      LR1110-710E

**VR-H2000-47**

\*Voltage Set Point:14.5V

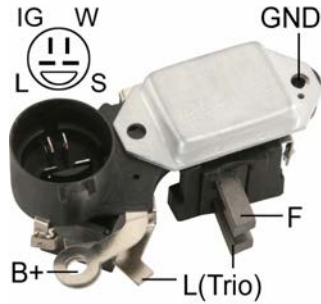

**Replaces**

**HITACHI :**  
L170G-1315

**MAGNETI MARELLI :**  
940038067

**VR-H2000-47C**

\*W/ integral design frame  
\*Voltage Set Point:14.5V



**Replaces**

**HITACHI :**  
L170G-1315

**MAGNETI MARELLI :**  
940038067

**VR-H2000-48**

\*Soft Start  
\*4.5 sec. LRC  
\*Short Circuit Protection  
\*\*"C" Terminal connect to Computer  
\*Voltage Set Point: 14.6V

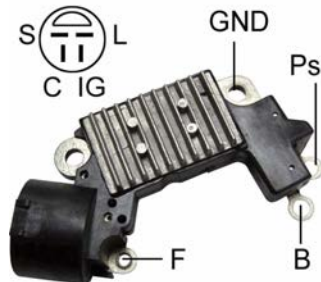

**Replaces**

**HITACHI :**  
234289

**Unit no.**

HITACHI

LR160-630C      LR160-729C      LR160-730C      LR160-731      LR170-755

ISUZU

2-90276-600-0      8-97101-816-2      8-97120-752-0      8-97130-776-0

**VR-H2000-4H**

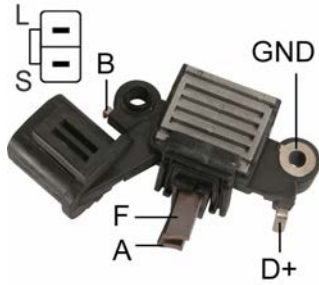

- \*L-S Terminals
- \*Repair Circuit: VR-H2000-10S
- \*Voltage Set Point: 14.5V
- \*w/o capacitor

**Replaces**

**HITACHI :**  
L180-3315            L190-3315  
**NISSAN :**  
23133-16E05        23133-F6100

**Unit no.**

HITACHI  
LR170-704            LR170-713            LR170-721            LR180-704            LR190-704            LR190-709

**VR-H2000-50**

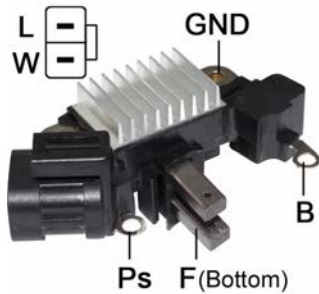

- \*L-W Terminals
- \*Soft Start
- \*2.5 sec. LRC
- \*Short Circuit Protection
- \*Voltage Set Point: 14.4V

**Replaces**

**HITACHI :**  
232443

**Unit no.**

HITACHI  
LR1100-502F        LR170-509E            LR170-511  
ISUZU  
8-97189-112-3      8-97189-113-4

**VR-H2000-51**



- \*P-D Terminals
- \*\*Traditional test method will immediately damage P-D regulator. Avoid damage using Mobiletron VR-H2009-66TF test fixture

**Unit no.**

HITACHI  
LR170-758



**VR-H2000-52**

\*S-L Terminals  
 \*Repair Circuit: VR-H2000-52S  
 \*Voltage Set Point:14.3V



Unit no.

KIA

OK012-18300

OK241-18300

OK012-18300

OK241-18300

**VR-H2000-53**

\*Same as VR-H2000-41 but with Over/Under Voltage Indication

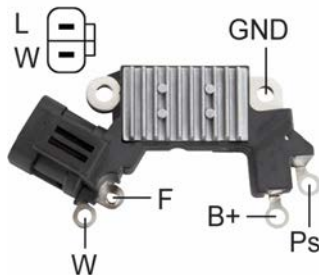

Replaces

HITACHI :

L170G-3319

L170G-6308

L170G-7315

**VR-H2000-55B**

\*24V  
 \*L Terminal Does Not Drive Choke  
 \*Repair Circuit: VR-H2000-55S  
 \*Voltage Set Point:28.5V

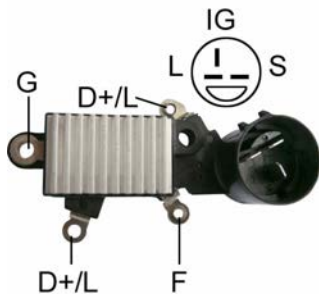

Unit no.

HITACHI

LR250-502C

LR250-507

LR250-507C

ISUZU

8-97075-883-2

8-97148-496-0

8-97148-496-1

**VR-H2000-56**

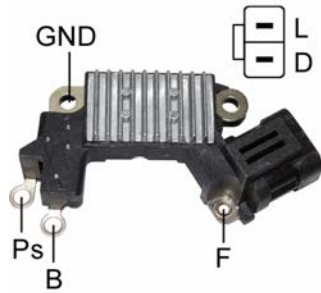

- \*L Terminal Does Not Drive Choke
- \*Load Response Control
- \*Soft Start
- \*Short Circuit Protection
- \*Voltage Set Point: 14.2V

Unit no.

HITACHI			
LR180-509C	LR180-510		
ISUZU			
29027-68100	89711-66973	89718-95490	89718-96490

**VR-H2000-57**

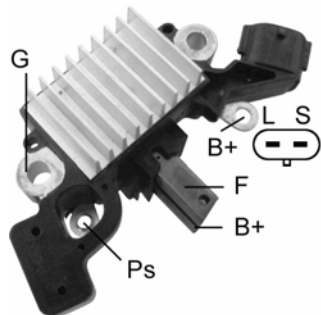

- \*S-L Terminals
- \*Soft Start
- \*Short Circuit Protection
- \*Voltage Set Point: 14.3V

Unit no.

HITACHI	
LR165-713	

**VR-H2000-5H**



- \*L-S Terminals
- \*Repair Circuit: VR-H2000-5S
- \*Voltage Set Point: 14.5V

Replaces

<b>HITACHI :</b>		
L160-43154	L170-53151	
<b>NISSAN :</b>		
23133-58S00	23133-58S01	23133-D4400

Unit no.

HITACHI					
LR160-715	LR170-715	LR170-715B	LR170-716	LR170-716B	LR170-717
LR170-727	LR180-715	LR180-719			
NISSAN					
23100-53A00					

## VR-H2000-62

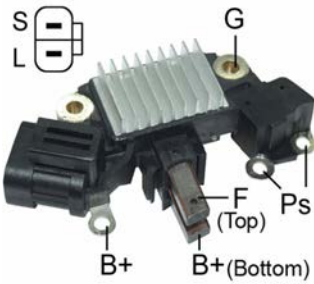

- \*A-Circuit
- \*Inactive Lamp
- \*S-L Terminals
- \*Soft Start
- \*Short Circuit Protection
- \*Voltage Set Point: 14.3V

### Replaces

#### HITACHI :

L180G-63401      L185G-5340      L190G-8340

#### SUBARU :

23812-AA000

### Unit no.

GM

977202264

HITACHI

LR1100-734      LR1100-734B      LR1100-734C      LR1110-712      LR1110-721      LR1110-721B

LR1110-721E      LR1110-721F      LR190-744      LR190-744R      LR190-761      LR1100-705E

LR1100-710      LR1100-710B      LR160-728E      LR170-749F      LR180-749C      LR180-749E

LR190-730C      LR190-734C      LR190-734E      LR1110- 713      LR1110- 713B      LR1110-717

LR1110-717B

ISUZU

29027-68300      89720-43320      29027-68200      89735-53400

NISSAN

23100-2W400      23100-3W400      23100-8J000      23100-8J100      23100-8J10A      23100-8J10B

## VR-H2000-63

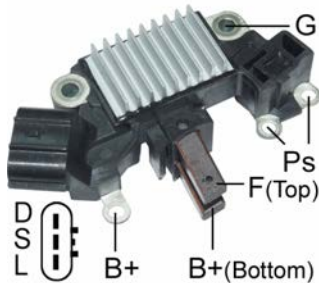

- \*D-S-L Terminals
- \*Soft Start
- \*8.5 sec. LRC
- \*Short Circuit Protection
- \*Voltage Set Point: 14.3V

### Unit no.

HITACHI

LR190-742

SUBARU

23700-AA31A

**VR-H2000-64**

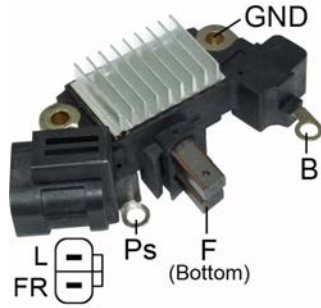

- \* L-FR Terminals
- \* L Terminals Does Not Drive Choke
- \* W/ Short Circuit Protection
- \* Soft Start
- \* 2.5 sec LRC
- \* Voltage Set Point: 14.3V

**Replaces**

<b>OPEL :</b>	13117236	13153236	135546130	135546140	93180104	1204434
<b>SAAB :</b>	12759595					

**Unit no.**

HITACHI	LR1100-508	LR1100-508B	LR1100-508C	LR1100-508F	LR1110-503	LR1110-503F
---------	------------	-------------	-------------	-------------	------------	-------------

**Used On**

<b>OPEL</b>		
Vectra 1.9 CDTI		2004-
Vectra C Estate 1.9 CDTI		2004-
<b>SAAB</b>		
9-3 1.9 TiD	YS3F	2004-
9-3 Convertible 1.9 TiD	YS3F	2006-
9-5 Estate 1.9 TiD		2005-
9-5 1.9 TiD	YS3E	2006-
9-5 Estate 1.9 TiD	YS3E	2006-

**VR-H2000-65**



- \*IG-L-S Terminals
- \*Repair Circuit: VR-H2000-9S
- \*Voltage Set Point: 14.6V

**Replaces**

**HITACHI :**  
L180G-2315

**Unit no.**

HITACHI	LR180-502R	LR180-501	LR180-501B	LR180-501C	LR180-502	LR180-503C
---------	------------	-----------	------------	------------	-----------	------------

**VR-H2000-6H**



\*S-L Terminals  
 \*Repair Circuit: VR-H2000-13S  
 \*Voltage Set Point: 14.5V

**Replaces**

**HITACHI :**  
 L170-1315

**NISSAN :**  
 23133-04P01

**Unit no.**

HITACHI	LR170-701	LR170-701B	LR170-702	LR170-702B
NISSAN	23100-05P01	23100-05P03	23100-14P01	23100-15P01

**VR-H2000-70B**

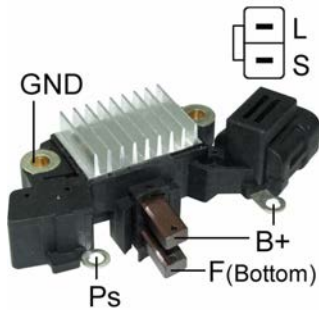

\*24V  
 \*Soft Start  
 \*Short Circuit Protection  
 \*Voltage Set Point: 28.5V

**Unit no.**

HITACHI	LR280-501	LR280-506	LR280-508
ISUZU	8-97248-914-1	8-97332-502-0	8-97351-574-0

**VR-H2000-71**



\*Soft Start  
 \*Short Circuit Protection  
 \*S Open Lamp Off  
 \*Voltage Set Point: 14.5V

**Unit no.**

HITACHI  
 LR1110-501

**VR-H2000-72**

\*Voltage Set Point: 14.5V

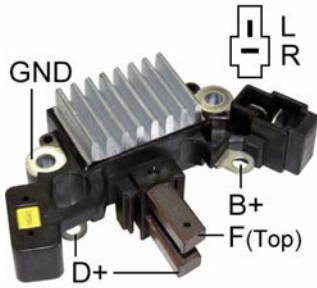

**Replaces**

HITACHI :  
IH784

**Unit no.**

HITACHI  
LR140-721      LR140-721B      LR140-721C  
YANMAR  
129930-77211

**VR-H2000-73**

- \*Soft Start
- \*Short Circuit Protection
- \*Voltage Set Point: 14.3V
- \*Regulated Voltage Control(RVC)
- \*Requires RVC01 tester box for testing



**Unit no.**

HITACHI  
LR1110-724      LR1110-724B

**VR-H2000-74**

- \*L-S Terminals
- \*Soft Start
- \*Short Circuit Protection
- \*Voltage Set Point: 14.5V



**Unit no.**

HITACHI  
LR1100-715

**VR-H2000-75B**

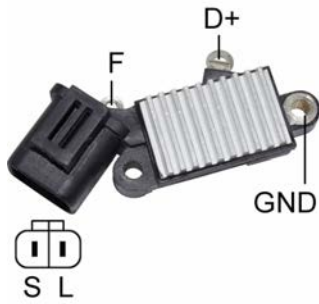

\*24V  
 \*Voltage Set Point: 28.5V

Unit no.   
 NISSAN  
 23100-0T002

**VR-H2000-76B**

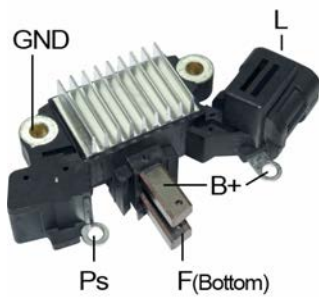

\*24V  
 \*Soft Start  
 \*Short Circuit Protection  
 \*Voltage Set Point: 28.5V

Unit no.   
 HITACHI  
 LR250-517  
 ISUZU  
 897351-5720

**VR-H2000-76BA**

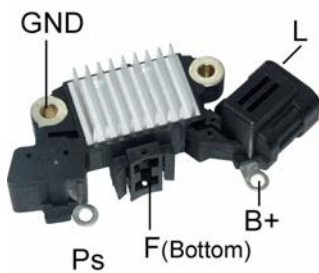

\*24V  
 \*Soft Start  
 \*Short Circuit Protection  
 \*w/o Brushes  
 \*Voltage Set Point: 28.5V

**Replaces**   
**NIKKO :**  
 0-35719-0260  
 Unit no.   
 NIKKO  
 8-98013-455-1

**VR-H2000-7H**

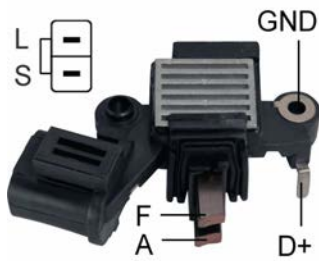

\*S-L Terminals  
 \*Voltage Set Point:14.5V  
 \*w/capacitor

**Replaces**

**HITACHI :**  
 L180-7315

**NISSAN :**  
 23133-26E60

**Unit no.**

HITACHI

LR170-721B      LR180-721B      LR190-704B      LR190-709B      LR190-711

**VR-H2000-8**

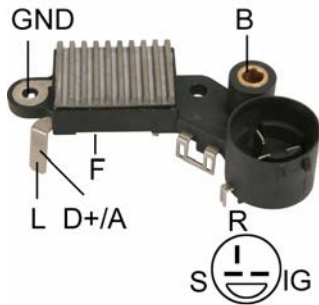

\*S-L Terminals  
 \*Voltage Set Point:14.5V

**Replaces**

**HITACHI :**  
 TR1Z-210A      TR1Z-210B

**Unit no.**

HITACHI

LR155-502B      LR155-502C      LR155-502E      LR155-503E      LR155-504

**VR-H2000-80B**

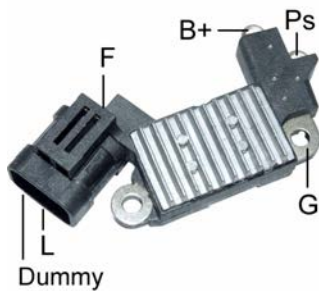

\*24V  
 \*Soft Start  
 \*Short Circuit Protection  
 \*Voltage Set Point 28.4V

**Unit no.**

HITACHI

LR250-508      LR250-707



**VR-H2000-80BA**

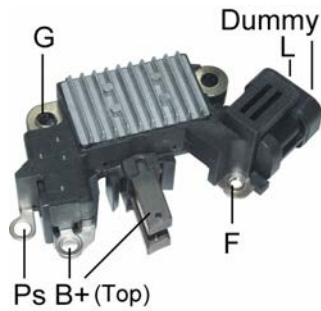

- \*24V
- \*Soft Start
- \*Short Circuit Protection
- \*Voltage Set Point 28.4V
- \*With Capacitor

Unit no.   
 HITACHI  
 LR250-508      LR250-707

**VR-H2000-84**

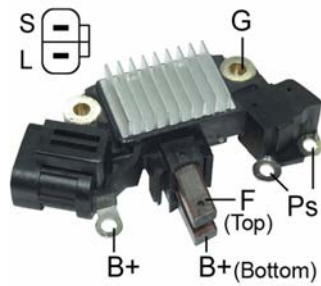

- \*S-L Terminals
- \*Soft Start
- \*2.5 sec. LRC
- \*Short Circuit Protection
- \*Voltage Set Point:14.3V

Unit no.   
 HITACHI  
 LR1110-713V      LR1110-713C  
 NISSAN  
 23100-AU400      23100-AU40D      23100-JA02C

**VR-H2000-85**

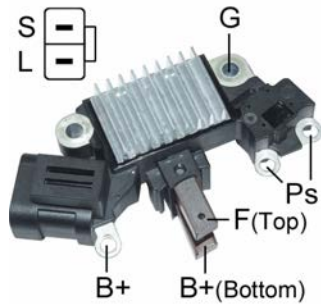

- \*Soft Start
- \*8.5 sec. LRC
- \*Short Circuit Protection
- \*Voltage Set Point: 14.3V

**Replaces**   
**HITACHI :**  
 IH746  
 Unit no.   
 HITACHI  
 LR1130-701  
 NISSAN  
 23100-8S100      23100-8S10A

## VR-H2000-86B



- \*24V
- \*Voltage Set Point: 28.5V
- \*Same as VR-H2000-55 w/brush holder

**Unit no.**

HITACHI		
LR250-502C	LR250-507	LR250-507C
ISUZU		
8-97075-883-2	8-97148-496-0	8-97148-496-1

## VR-H2000-87



- \*Voltage Set Point: 14.4V

**Unit no.**

HITACHI		
LR1140-803E	LR190-772	LR190-773
NISSAN		
23100-ED50A		

## VR-H2000-88

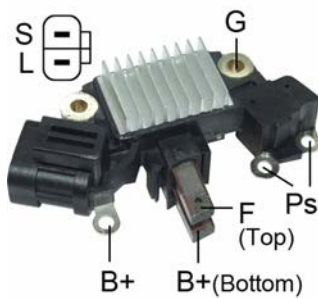

- \*Soft Start
- \*Short Circuit Protection
- \*S Open Lamp On
- \*Voltage Set Point: 14.3V

**Replaces**

<b>HITACHI :</b>	
L180G-63401	L190G-8340
<b>NISSAN :</b>	
23215-0V000	23215-2J602

**Unit no.**

HITACHI	
LR1110-713C	
NISSAN	
23100-AU400	

**VR-H2000-89**



- \*Voltage Set Point: 14.3V
- \*Soft Start
- \*Short Circuit Protection
- \*Regulated Voltage Control(RVC)
- \*Requires RVC01 tester box for testing

Unit no.

HITACHI		
LR1130-703	LR1130-703A	LR1130-703B
NISSAN		
23100-EA200	23100-EA20A	

**VR-H2000-9**



- \*S-IG-L Terminals
- \*Repair Circuit: VR-H2000-9S
- \*Voltage Set Point: 14.5V

Replaces

ISUZU :  
8-94462-849-0

Unit no.

HITACHI			
LR150-704	LR150-704H	LR160-718	LR160-718H
ISUZU			
8-94136-210-0	8-94449-265-0	8-94449-731-0	

**VR-H2000-91**



- \*Soft Start
- \*Short Circuit Protection
- \*Voltage Set Point: 14.3V
- \*Regulated Voltage Control(RVC)
- \*Requires RVC01 tester box for testing

Unit no.

HITACHI		
LR140-803	LR140-806	LR140-807
NISSAN		
23100-ED500		

Used On

NISSAN  
Tiida

**VR-H2000-92B**

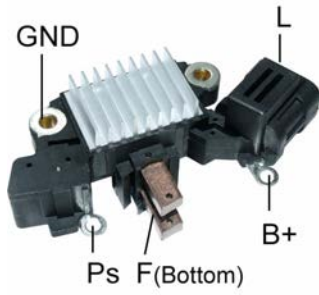

- \*24V
- \*Soft Start
- \*Short Circuit Protection
- \*Voltage Set Point:28.0V

Unit no.

HITACHI  
LR250-517

**VR-H2000-94B**

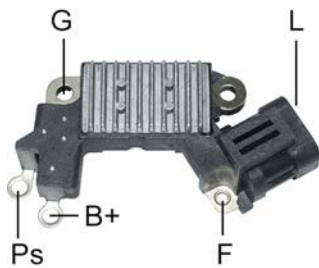

- \*24V
- \*Soft Start
- \*Short Circuit Protection
- \*Voltage Set Point: 28.4V

Replaces

ISUZU :  
8-971860551-1

Unit no.

HITACHI  
LR250-511

**VR-H2009-192B**

\*Voltage Set Point: 28.4V

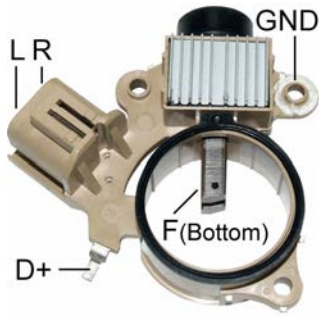

Unit no. [redacted]  
HYUNDAI  
37300-41750 37300-41751

**VR-MD13B**

\*24V

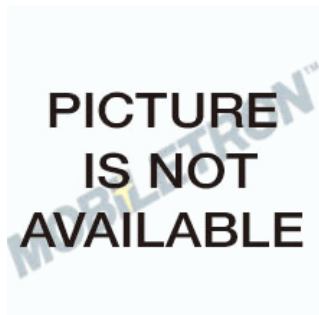

Replaces [redacted]  
HYUNDAI :  
37370-72000 37370-8Y020  
Unit no. [redacted]  
KIA  
OK87T-18300  
MANDO  
AB250474

**VR-MD14B**

\*24V

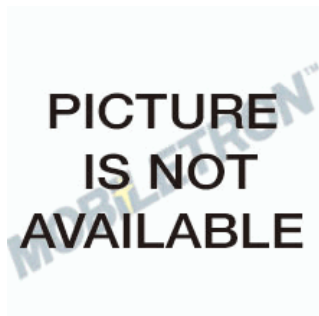

Replaces [redacted]  
MANDO :  
37300-45001  
Unit no. [redacted]  
HYUNDAI  
37300-45001  
MANDO  
AB240456

**VR-V018**

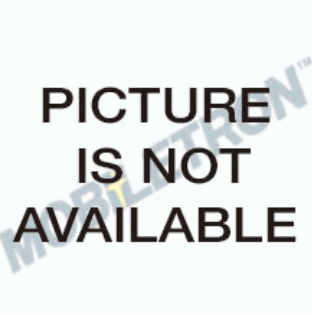

Unit no.   
HYUNDAI  
37300-2F100

**VR-V019B**

\*24V

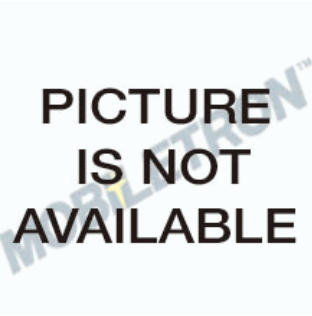

Unit no.   
HYUNDAI  
37300-48000

**VR-IK01**

\*Voltage Set Point:14.2V

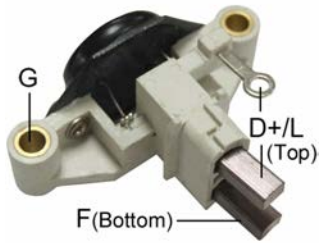

**Replaces**

**ISKRA :**

11-125-165      16-906-481

**Unit no.**

ISKRA

11201666      11201667      AAK5114      AAK5115

**VR-IK019**

\*32mm OD  
\*Voltage Set Point:14.7V

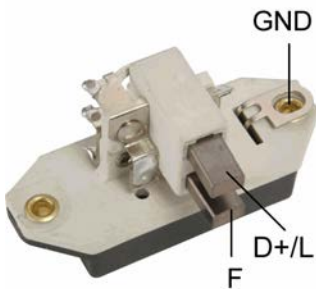

**Replaces**

**ISKRA :**

11125019	11125053	11125054	11125056	11125065	11125085
16905323	AER1401	AER1406	AER1505	AER1506	AER1508
AER1510	11125139	11125177	11125199		

**Unit no.**

ISKRA

11201273      AAK1314

**VR-IK02**

\*Voltage Set Point: 14.6V



**Replaces**

**ISKRA :**

11-125-124      16-906-352

**Unit no.**

ISKRA

11201440	11201498	11201534	11201769	AAK5102	AAK5105
AAK5108	AAK5136				

**VR-IK029**

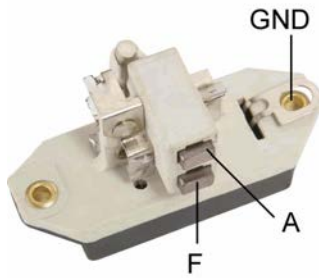

\*24V  
 \*32mm OD  
 \*Voltage Set Point:28.3V

**Replaces**

**ISKRA :**

11-125-029	11-125-047	11-125-087	16-905-304	AER1404	AER1504
AER1511					

**Unit no.**

**ISKRA**

11201050	11201052	11201055	11201066	11201069	11201087
11201098	11201107	11201151	11201162	11201186	11201201
11201360	11201522	11201555	11201557	11201574	11201586
11201633	11201635	11201699	11201705	AAK1107	AAK1109
AAK1110	AAK1113	AAK1115	AAK1125	AAK1131	AAK1134
AAK1153	AAK1160	AAK1167	AAK1309	AAK1347	AAK1352
AAK1367	AAK3520	AAK3557	AAK4179	AAK4507	AAK4509
AAK4531	AAK4560				

**VR-IK149**

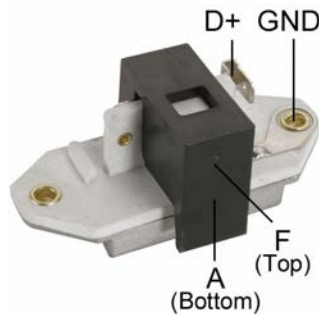

\*Voltage Set Point:14.2V

**Replaces**

**ISKRA :**

11-125-122	11-125-149	11-201-293	AER1528	AER1543
------------	------------	------------	---------	---------

**LADA :**

21083701010	224370701	T2223701010
-------------	-----------	-------------

**Unit no.**

**ISKRA**

AAK4127

**VR-IK15**

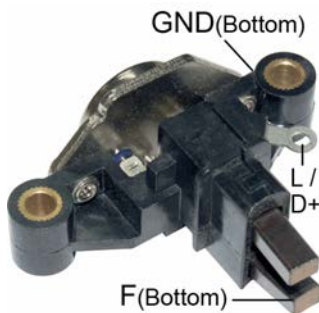

\*W/module packed like Bosch OE design  
 \*Short Circuit Protection  
 \*Voltage Set Point: 14.2V

**Replaces**

**ISKRA :**

AER1603	11-125-124
---------	------------



**VR-JD357**

\*Voltage Set Point: 14.5V

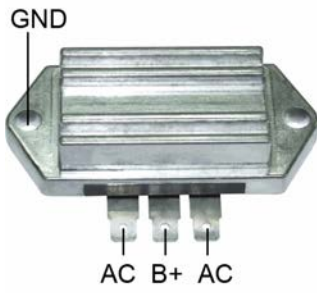

**Replaces**

**JOHN DEERE :**

AM102596      AM123296      AM106357      AM34738

**VR-H2009-116**

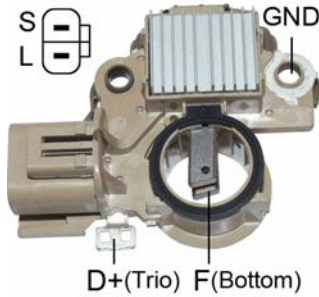

- \* Inactive Lamp
- \* S-L Terminals
- \* Voltage Set Point:14.5V

**Replaces**

**KIA :**

0K201-18-300B    0K24A-18-300A    0K29T-18-300    0K201-18-W70A

**MANDO :**

AB170036    AB170066    AB180092    TA500C02001A    TA500C02701

**VALEO :**

234252

**Used On**

**KIA**

Sephia    1.6L    1993-1995

**VR-K01**



- \*Voltage Set Point:14.7V

**Unit no.**

**POONG SUNG**

02121-8025    02121-8027    02121-8070    02121-8071    02121-8073    02121-8074

02121-9012    02121-9020    02121-9021    02121-9022

**Used On**

**KIA**

Retona 2.0 TD  
Sportage 2.0 TD 4WD

**VR-K01B**



- \*24V
- \*Voltage Setting:28.3V

**Unit no.**

**POONG SUNG**

02122-3030

**VR-K02**

\*Voltage Set Point: 14.5V



**Unit no.**

HYUNDAI  
 37300-12470  
 KIA  
 OK72A-18-300  
 POONG SUNG  
 02131-9020      02131-9021

**VR-K05**

\*S-L Terminals  
 \*Voltage Set Point: 14.3V

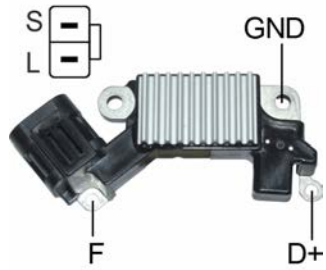

**Replaces**

**KIA :**  
 37370-27011  
**POONG SUNG :**  
 235522

**Unit no.**

HYUNDAI				
37300-27011	37300-27012	37300-27013	37300-27030	37300-27031
POONG SUNG				
02131-9111	02131-9112	02131-9311	02131-9113	

**Used On**

<b>HYUNDAI</b>	
Elantra 2.0L 16V	2001-ON
Santa FE 2.0L 16V	2001-ON
<b>KIA</b>	
Sportage 2.0L	2005-ON

VR-K09

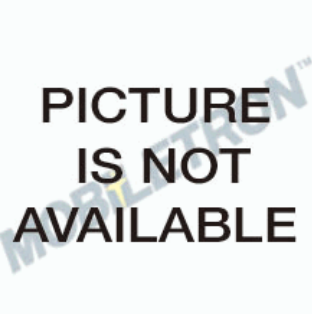

**Replaces**

DELCO :  
220736

**VR-LD150A**

\*Voltage Set Point:14.5V

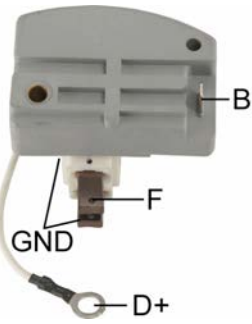

**Replaces**

**LADA :**  
 173701010      21033701500      21053701500  
**LUCAS :**  
 21129167      21229167      UCB900  
**MAGNETI MARELLI :**  
 940038112

**Unit no.**

LADA  
 2105-370-1010      2205-370-1005

**VR-LD160**

\*Voltage Set Point:14.5V

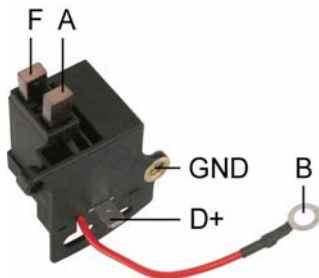

**Replaces**

**LADA :**  
 173702      21083701500      56-7-625/5      EP1  
**LUCAS :**  
 21229189      UCB902

**VR-LC100**

\*Voltage Set Point:14.5V

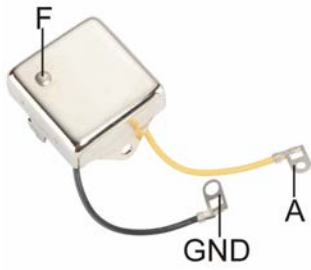

**Replaces**

**BL/JAGUAR :**

37H6911	520076	607687	AAU4842	ABU9969	BAU4443
JS485					

**BOSCH :**

0-986-192-006

**LUCAS :**

37534	37538	37541	37555	37558	37561
37565	37566	37581	37587	37612	37628
37639	37647	37653	37657	37672	37679
37683	UCB100	UCB100X	UCB114		

**MASSEY FERGUSON :**

1887416M1	1897383M1
-----------	-----------

**MOTORCRAFT :**

EGR304	EGR351
--------	--------

**TALBOT :**

75062449

**VALEO :**

505044	505052	505096	A554616A	NB180
--------	--------	--------	----------	-------

**VALEO(MOTOROLA) :**

9RC7037

**Unit no.**

**LUCAS**

23562	23563	23565	23566	23572	23581
23582	23584	23589	23590	23592	23593
23602A	23602B	23603	23606	23615	23617
23620	23634	23636	23637	23638	23640
23644	23646	23647	23648	23674	23675
23682	23685	23700	23709	23713	23715
23716	23718	23725	23726	23729	23730
23734	23737	23765	23774	23775	23801
23802	23808	23842	23850	23851	23852
23888	23963				

**VR-LC106**

\*L Terminal Does Not Drive Choke  
\*Voltage Set Point:14.4V

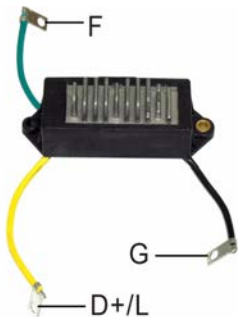

**Replaces**

**LUCAS :**

26215045	SR30
----------	------

**Used On**

**SUZUKI**

Maruti 800

**VR-LC107**

\*L Terminal Does Not Drive Choke  
 \*Voltage Set Point:14.4V

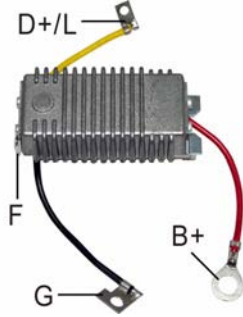

**Replaces**

**LUCAS :**  
 26938068B TR15

**Used On**

**TATA**  
 407 Truck

**VR-LC108**

\*L Terminal Does Not Drive Choke  
 \*Voltage Set Point:27.8V

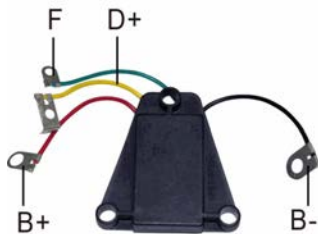

**Replaces**

**LUCAS :**  
 26938063A SR40

**Used On**

**LEYLAND/DAF**  
 Truck

**VR-LC110**

\*L Terminal Does Not Drive Choke  
 \*Voltage Set Point:14.6V



**Replaces**

**LUCAS :**  
 26214105 GA15

**Used On**

**HYUNDAI**  
 Santro

**VR-LC111**

\*Voltage Set Point:14.5V



**Replaces**

**CASE :**

K262266

**DELCO REMY (LUCAS) :**

54048473

**FORD :**

6133746                    84AB-10316AA

**LUCAS :**

37701	37703	37705	37707	54048473	54048600
54205986	54206177	54206448	54206467	54206645	54207336
54208417	UCB148	UCB148X	UCB150	UCB150X	UCB151
UCB151X	230283	37707A	54206688	UCB152	28000010
28001010	66201555				

**MAGNETI MARELLI :**

28000                    28001                    28000010

**MASSEY FERGUSON :**

1865974M1            1897699M91            345773M91            3474604M91            3476714M91

**NISSAN :**

23133-Q9000

**PERKINS :**

28710252

**ROVER :**

BAU4919	BAU5265	BAU5958	FBU2243	FBV2243	RTC5044
RTC5370	RTC5670				

**RVI :**

5430021883

**VALEO :**

A554711A

**Unit no.**

**LUCAS**

24145	24145AD	24156	24156AD	24157	24157AD
24158	24161	24169	24169AE	24188AC	24198
24198AB	24199	24199AB	24200	24200A	24202
24203	24203A	24206	24206AB	24207	24207A
24208	24208AB	24209AB			

**NISSAN**

23100-71J00



**VR-LC111B**

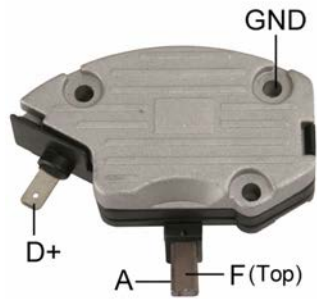

\*24V  
\*Voltage Set Point:28.3V

**Replaces**

<b>LUCAS :</b>				
28002	54022415	84959	UCB155	

**Unit no.**

<b>LUCAS</b>				
24299	24406	A127	NAB901	NAB903

**VR-LC112**

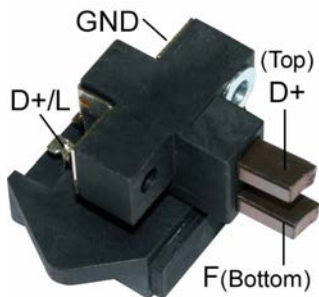

\*A-Circuit  
\*Inactive Lamp  
\*Voltage Set Point:14.3V

**Replaces**

<b>LUCAS :</b>		
2193818A	SR60	26938161A

**Unit no.**

<b>LUCAS</b>			
26021117	26021326	284315400101	285001075

**Used On**

**TATA**  
Indica  
Indigo

**VR-LC113L**

\*Voltage Set Point: 12.5V

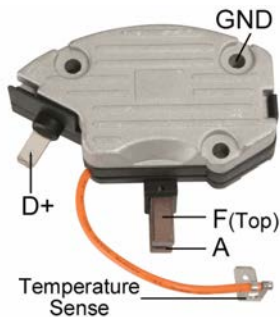

**Replaces**

**FORD :**

E3NN-10B376AD E7NN-10316AA

**LUCAS :**

37735 UCB153

**Unit no.**

FORD

E8NN-10316

LUCAS

24246A	24256AC	24258A	24262A	24273	24273A
24274A	24276	24277	24278A	24279A	24295A
LRA522	LRA530				

**VR-LC115**

\*Voltage Set Point: 14.4V

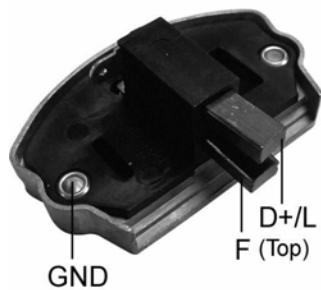

**Replaces**

**LUCAS :**

35381720

**Unit no.**

LUCAS

35213795	35213940	35213995	35214100
----------	----------	----------	----------

**VR-LC200**

\*Voltage Set Point:14.5V

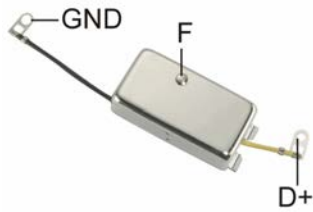

**Replaces**

**BL/JAGUAR :**

AEU1526	AEU1669	AEU1915	AEU2750	AEU4007A	BBU2117
BBU3021	BBU3773				

**FORD :**

1591687	81DB-10316CA
---------	--------------

**LUCAS :**

37624	37636	37640	37659	37661	37666
37667	37684	37686	37690	37709	UCB124X
UCB126	UCB129	UCB129X	UCB133	UCB133X	UCB134
UCB134X	UCB137	UCB139	UCB142		

**MAGNETI MARELLI :**

940038132

**MASSEY FERGUSON :**

1897266M1	1897294M1	3473155M1	3473593M1
-----------	-----------	-----------	-----------

**MOTORCRAFT :**

EGR311	EGR313
--------	--------

**Unit no.**

LUCAS					
23970	23971	23996	24011	24029	24030
24037	24049	24056	24061	24087	24096
24101	24102	24115	24142	24173	24229
24238					

**VR-LC201**

\*Voltage Set Point:14.5V

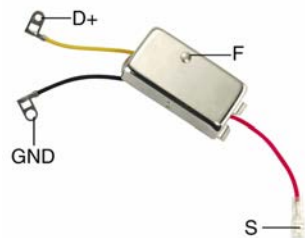

**Replaces**

**LUCAS :**

37621	37659	37684	UCB126
-------	-------	-------	--------

**MOTORCRAFT :**

EGR314

**Unit no.**

LUCAS			
23996	24049	24096	24115

## VR-LC302

\*Voltage Set Point:14.2V

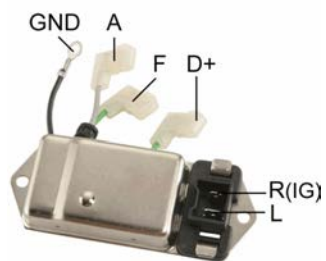

### Replaces

**INDIEL :**  
35381400                      35381690

**NOSSO :**  
ID212V

### Unit no.

RENAULT  
R11                              R18

## VR-LC303

\*Voltage Set Point:14.2V

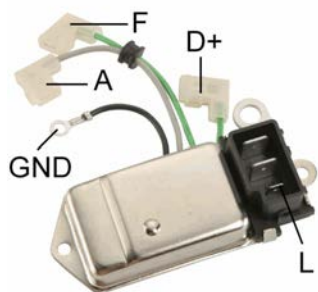

### Replaces

**INDIEL :**  
35381540                      35381605

**NOSSO :**  
ID312V

### Used On

**FORD**  
Sierra 1.6  
Sierra 2.3

## VR-LC303B

\*24V  
\*Voltage Set Point:28.3V

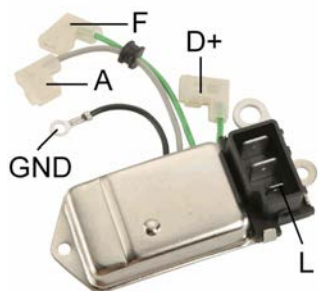

### Replaces

**INDIEL :**  
35381640  
**NOSSO :**  
RNI-1640

## VR-LC304

\*Voltage Set Point:14.2V

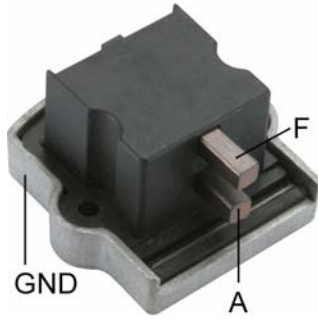

### Replaces

**INDIEL :**  
35381130                    35381512  
**NOSSO :**  
IF12V

## VR-LC304B

\*24V  
\*Voltage Set Point:28.3V

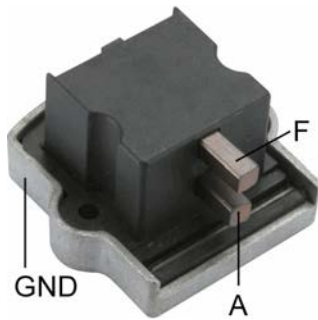

### Replaces

**INDIEL :**  
35681175  
**NOSSO :**  
IF24V

## VR-LC304NB

\*24V  
\*Voltage Set Point:28.3V

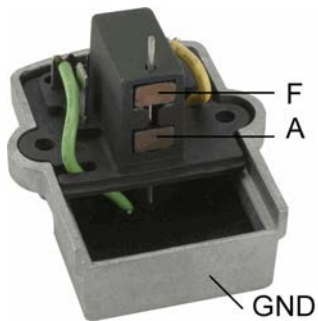

### Replaces

**INDIEL :**  
35381680  
**NOSSO :**  
RNI1680

**VR-LC305**

\*Voltage Set Point:14.5V

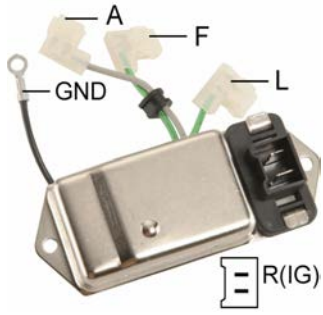

**Replaces**

**INDIEL :**  
35381630

**VR-F110A**

\*Voltage Set Point:14.7V



**Replaces**

**BOSCH :**

9-190-110-032      9-190-333-707

**ELMOT :**

RC212B              RC212D              RC212E

**FEMSA :**

GRO12-3Y          GRO12-X1Y          GRO12-X30          RFH12-11          RFH12-7

**FIAT :**

4074763            4095889            4095898            4191122            4202969            4296100

4474566            5011933

**ISKRA :**

11-125-110          AER3007

**LADA :**

21013702000

**MAGNETI MARELLI :**

63408004            63408005            63408007            63472000            64808020            64808101

64808103            RTT110B            RTT110BBJ          RTT110BJ

**VALEO :**

505050              505051              505053

**VALEO(MOTOROLA) :**

9RH7021            9RH7029            9RH7044

**VR-F110B**

\*24V  
\*Voltage Set Point:28.3V



**Replaces**

**BOSCH :**

9-190-333-704

**ELMOT :**

RC128              RC224

**FEMSA :**

RFH24-4

**FIAT :**

4087071            4112453            4205243            4215948            4288170            4296659

4474531            4701050            4754010

**ISKRA :**

11-125-091          AER3001

**LUCAS :**

2193008            NCB811

**MAGNETI MARELLI :**

63408305            63408306            64808102            64808108            RTT110C            RTT110CCJ

RTT110J

**VALEO :**

505054

**VALEO(MOTOROLA) :**

9RH8043

**VR-F113A**

\*Voltage Set Point:14.7V

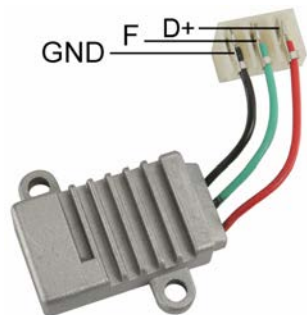

**Replaces**

**FIAT :**

4474966

**LUCAS :**

21222128           UCB809

**MAGNETI MARELLI :**

64808130           99908140           RTT113A

**Unit no.**

**MAGNETI MARELLI**

63303501	63303502	63303522	63303700	63303701	63303702
63303703	63303720	63303721	63303722	63303731	63303733
63303780	63303790				

**VR-F113B**

\*24V  
\*Voltage Set Point:28.3V

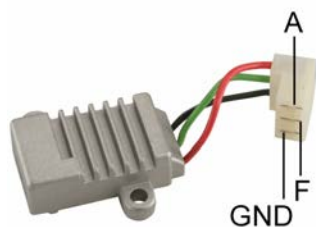

**Replaces**

**FIAT :**

9986111

**LUCAS :**

21222130           UCB810

**MAGNETI MARELLI :**

64808132           RTT113           RTT113B

**Unit no.**

**MAGNETI MARELLI**

63301201	63301241	63304480	63304500	63304520	63304530
63304550	63304560	63304570	63304580	79014078	



**VR-F114A**

\*A-Circuit  
 \*Inactive Lamp  
 \*Voltage Set Point:14.5V

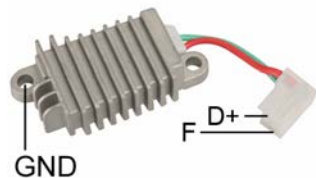

**Replaces**

**BOSCH :**

0-986-192-005

**FIAT :**

4475112                    4721593

**LUCAS :**

21222081                    21222106                    21932004                    UCB802                    UCB805

**MAGNETI MARELLI :**

64808106                    64808140                    64808143                    RTT114A

**Unit no.**

**FIAT**

4393206                    4395131                    5920974

**MAGNETI MARELLI**

63300905	63300925	63305100	63305101	63305102	63305103
63305120	63305122	63305123	63305130	63305131	63305150
63305226	63305236	63305246	63305256	63305270	63305310
63305400	63305401	63305402	63305403	63305404	63305405
63305406	63305420	63305423	63305425	63305426	63305430
63305431	63305440	63305442	63305450	63305506	63305526
63305536	63305556	63305566	63305621	63305700	63305701
63305702	63305711	63305712	63305720	63305730	63305800
63305801	63305802	63305820	63305821	63305822	63305832
63305842	63305862	63305900	63306700	63306701	63306721
63306730	63307100	63307101	63307103	63307105	63307106
63307108	63307120	63307123	63307125	63307126	63307127
63307128	63307130	63307131	63307150	63307160	63307206
63307207	63307208	63307218	63307227	63307236	63307246
63307256	63307270	63307310	63307400	63307403	63307405
63307406	63307407	63307408	63307410	63307420	63307423
63307428	63307429	63307430	63307431	63307441	63307442
63307450	63307452	63307460	63307470	63307490	63307503
63307506	63307508	63307509	63307518	63307523	63307526
63307536	63307556	63307566	63307602	63307604	63307622
63307634	63307801	63307802	63307804	63307821	63307822
63307824	63307841	63307842	63307851	63307862	63307872
63308701	63308721	63308731	62307526	63305206	63305400
63305401	63305403	63305404	63305405	63307401	AA125-14V-55A-V1

AA125-14V-55A-V3AA125-14V-55A-V4AA125-14V-55A-V5

**VR-F114B**

\*24V  
\*Voltage Set Point:28.3V



**Replaces**

<b>FIAT :</b>		
9959694	9983355	
<b>LUCAS :</b>		
21222119	UCB807	
<b>MAGNETI MARELLI :</b>		
64808141	81200270	RTT114B

**Unit no.**

<b>FIAT</b>		
4715786	4738563	
<b>MAGNETI MARELLI</b>		
63306000	63306300	AA125-28-30A

**VR-F118**

\*Voltage Set Point:14.6V

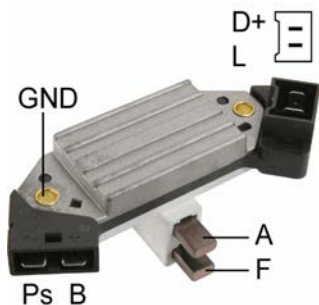

**Replaces**

<b>MAGNETI MARELLI :</b>					
64808182	64808184	64808241	64808243	83607041	83607111
RTT118C	RTT118E	RTT118J			

**Unit no.**

<b>MAGNETI MARELLI</b>					
63320027	63320039	63320041	63321057	63321081	63321083

**VR-F119**

\*Voltage Set Point:14.7V

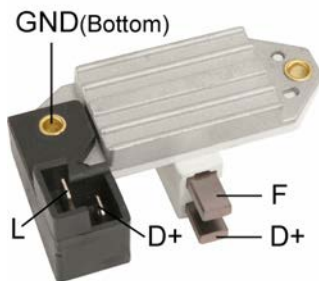

**Replaces**

**DELCO REMY (LUCAS) :**  
21222127

**FIAT :**  
9939826                    9941193

**ISKRA :**  
11125097

**LUCAS :**  
2122121                    581200220000                    581200220100                    21222127                    UCB808

**MAGNETI MARELLI :**  
58120022                    79707161                    79707481                    83600151                    RTT119A                    RTT119AAC  
RTT119AC                    5812002200

**VALEO(DUCELLIER) :**  
592967

**Unit no.**

MAGNETI MARELLI  
633-200SERIES    633-210SERIES

**VR-F119B**

\*24V  
\*Voltage Set Point:28.3V

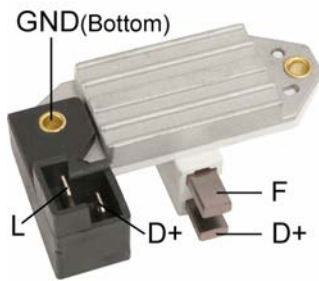

**Replaces**

**FIAT :**  
8190407

**LUCAS :**  
21222126                    UCB806

**MAGNETI MARELLI :**  
79707441                    RTT119B

**VALEO(DUCELLIER) :**  
592968

**Unit no.**

MAGNETI MARELLI  
63320025                    63320052                    63320057                    63320118                    63321046                    63321047  
63321048                    63321049                    63321050                    63321052                    63321055                    63321063  
63321102                    63321104                    63321110

**VR-F121**

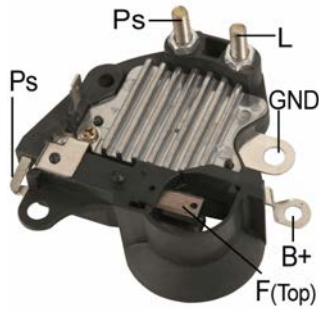

- \*Soft Start
- \*2.5 sec. LRC
- \*Short Circuit Protection
- \*Voltage Set Point:14.7V

**Replaces**

**MAGNETI MARELLI :**  
28018A

**Unit no.**

MAGNETI MARELLI

54022459	54022469	54022470	54022606	63320228	63320289
63320312	63320313	63320314	63320315	63321240	63321243
63321253	63321258				

**VR-F121T**

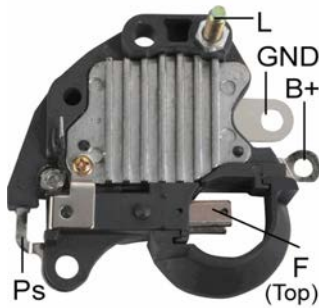

- \*Soft Start
- \*2.5 sec. LRC
- \*Short Circuit Protection
- \*Voltage Set Point:14.7V

**Replaces**

**FIAT :**

9946618            9950586

**MAGNETI MARELLI :**

24TR	24TR/B	54209305	83614251	RTM24TR
------	--------	----------	----------	---------

**Unit no.**

MAGNETI MARELLI

A127I

**VR-F150A**

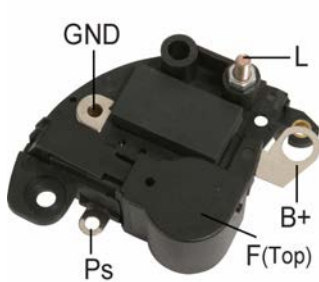

- \*W/Capacitor
- \*W/Choke
- \*Voltage Set Point:14.7V

**Replaces**

**MAGNETI MARELLI :**

83615921            RTM150B

**Unit no.**

MAGNETI MARELLI

63321261	63341261	A127IM
----------	----------	--------

**VR-F151A**



\*W/Capacitor  
 \*W/Choke  
 \*Voltage Set Point:14.4V

**Replaces**

**FIAT :**

9946542

**MAGNETI MARELLI :**

581200530010	581200530000	501200530010	331850	85563051010	8556351010
85561291	RTM151C	RTM152A	83611361	RTM121A	RTM151A
RTM151B	85563051	58120053	000083611361	000085561291	058120056010
083611361010	083613011010	501200530000			

**Unit no.**

MAGNETI MARELLI

63320200	63320203	63320219	63320227	63320238	63321200
63321204	63321233	63321234	63321235	6332124	63321252
A1271	A1271R	AA1151			

**VR-F153A**



\*W/Capacitor  
 \*W/Choke  
 \*Voltage Set Point:14.7V

**Replaces**

**MAGNETI MARELLI :**

83617181	RTM153B
----------	---------

**Unit no.**

LANDROVER

63321240

MAGNETI MARELLI

63321321	63321333	63321351	63321352	63321353	63321354
63341240	63341321	63341333	63341351	63341352	63341353
63341354	A127IM	AMR2938			

**VR-F153MB**



\*24V  
\*Voltage Set Point:28.3V

Unit no.   
MAGNETI MARELLI  
54022667

**VR-F154**



\*w/battery sensor  
\*Voltage Set Point:12.6V

**Replaces**   
**MAGNETI MARELLI :**  
54209276

Unit no.   
MAGNETI MARELLI  
54022443

**VR-F154B**

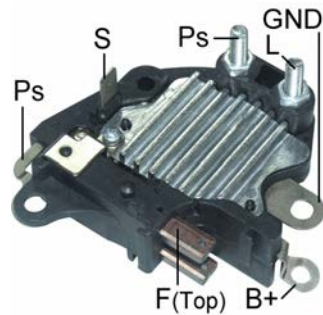

\*Short Circuit Protection  
\*Voltage Set Point: 28.5V

Unit no.   
DENSO  
102211-8140      102211-8150  
MAGNETI MARELLI  
63377466      63377465

**VR-F155**

\*Voltage Set Point:14.4V

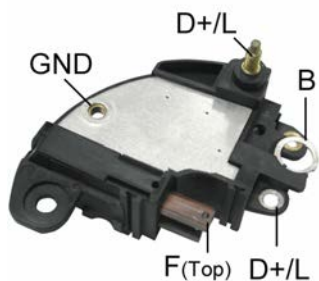

**Replaces**

**MAGNETI MARELLI :**

85562061      85563501

**Unit no.**

MAGNETI MARELLI

63321671      63321641      63341641      63341671

**VR-F156**

\*Voltage Set Point: 14.0V

\*Regulated Voltage Control(RVC)

\*Requires RVC01 tester box for testing

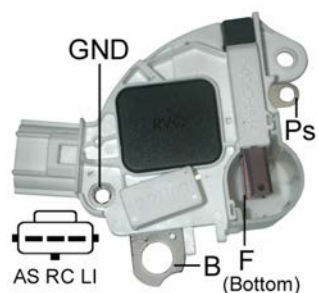

**Replaces**

**LUCAS :**

83627781010      85562541010

**MAGNETI MARELLI :**

83627781      85562541      85562801      85582601      940016012300      085582601010

85562541      85562801

**Unit no.**

FORD

98AB10300GD

MAGNETI MARELLI

63321678      63321679      63321746      63341679

VALEO(PARIS RHONE)

A115I

**VR-F157**

\*Voltage Set Point:14.4V

\*Self Exciting

\*Soft Start

\*W/Short Circuit Protection

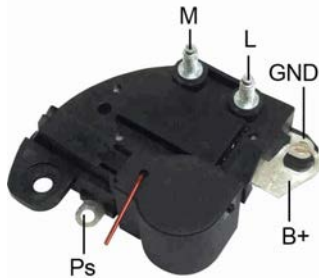

**Replaces**

**MAGNETI MARELLI :**

85563491      RTM300.01

**Unit no.**

MAGNETI MARELLI

63321733      63321734      63321740      63321741      63321829      A115IM

**VR-F158**

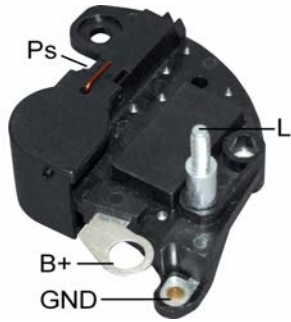

\*Voltage Set Point:14.4V  
 \*Soft Start  
 \*W/Short Circuit Protection

**Replaces**

**MAGNETI MARELLI :**

85562881                      85562731

**Unit no.**

MAGNETI MARELLI

A127IM	63321491	63321494	63321507	63321712	63321713
63321718					

**VR-F159**



\*Voltage Set Point:14.4V  
 \*Soft Start  
 \*W/Short Circuit Protection

**Replaces**

**MAGNETI MARELLI :**

85552506

**Unit no.**

DENSO

102211-8611                      102211-8660

FIAT

46835095                      51784846

MAGNETI MARELLI

RTM200.13



**VR-F160**

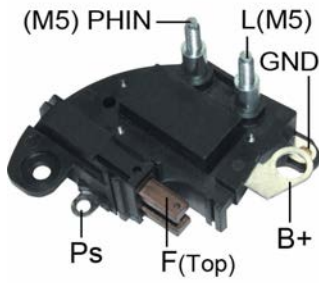

- \*Soft Start
- \*2.5 sec. LRC
- \*Short Circuit Protection
- \*PHIN : Activated terminal
- \*Self Exciting
- \*Voltage Set Point:14.4V

**Replaces**

**MAGNETI MARELLI :**

85563481      RTM200.03      RTM200.09

**Unit no.**

**MAGNETI MARELLI**

63321702      63321658      63320545      63320535      63341658      63341702

**Used On**

**SMART**

Cabrio 0.6	52kW	2002-2004
City Coupe	33kW	1998-2004

**VR-MP134**

\*Voltage Set Point:14.5V

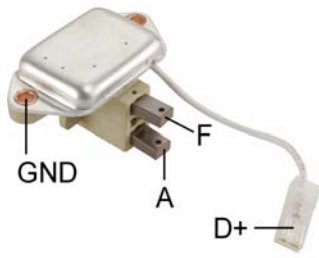

**Replaces**

**MAGNETON-PAL :**

443930134291	443930136111	443930136131	136111	143431	134291
134541	136110	136131	143411	443930134540	443930134541
443930135641	443930136110				

**Unit no.**

**MAGNETON-PAL**

443113516630	443113516631	443113516632	443113516650	443113516653
--------------	--------------	--------------	--------------	--------------

**VR-MP419**

\*Voltage Set Point:14.5V



**Replaces**

**MAGNETON-PAL :**

443116419070	443116419071
--------------	--------------

**SKODA :**

907040114

**VR-H2009-106**



- \*C-S-L-FR Terminals
- \*Soft Start
- \*Inactive Lamp
- \*Voltage Set Point:14.3V

Unit no.

HYUNDAI  
37300-38310  
MANDO  
AB195126

**VR-H2009-86**



- \*L-S Terminals
- \*Voltage Set Point:14.2V

Replaces

**KIA :**  
37370-22200  
**VALEO :**  
TA500C02401

Unit no.

HYUNDAI  
37300-22200

**VR-H2009-89**

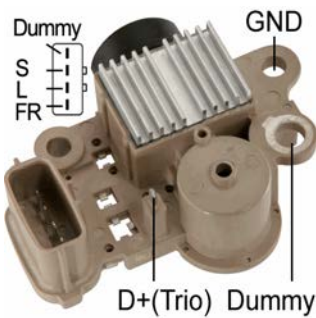

- \*Dummy-S-L-FR Terminals
- \*Voltage Set Point:14.3V
- \*Repair Circuit:VR-H2009-89S
- \*for EF SONATA

Replaces

**MANDO :**  
TA000A29102

Unit no.

HYUNDAI  
37300-38310

**VR-MD01**

\*Voltage Set Point:14.2V

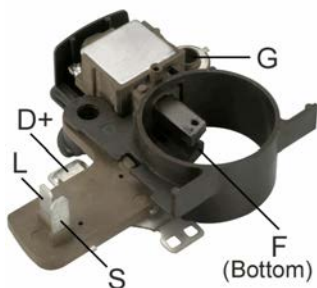

**Replaces**

**KIA :**

37370-42000      37370-42540

**MANDO :**

37300-42010      37300-42502      37300-42750

**VALEO :**

139669

**Unit no.**

HYUNDAI

37300-42204

**VR-MD03**

\*Adjustable Voltage

\*Black: B-

\*Green:D+

\*Red: Sense

\*Blue: Ignition

\*Orange: Field



**Replaces**

**MANDO :**

12449      42786

**Unit no.**

MANDO

AR150BA      AR150CA

**VR-MD04**

\*Adjustable Voltage

\*Black: B-

\*Green:D+

\*Red: Sense

\*Blue: Ignition

\*Orange: Fiel

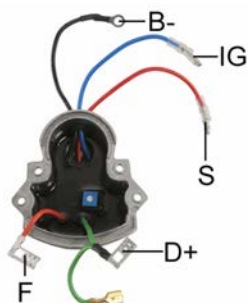

**Replaces**

**MANDO :**

3ER1071      42785

**VALEO :**

3ER1071      42785

**Unit no.**

MANDO

AR150A      AR150AA      AR150AC

**VR-MD06**

\*Voltage Setting:14.5V

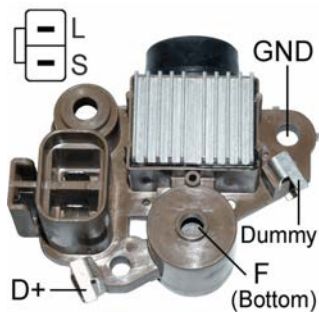

**Replaces**

**HYUNDAI :**

37370-22600

**MANDO :**

TA500-C09001

**Unit no.**

HYUNDAI

37300-22600

MANDO

AB180128

**VR-MD06L**

\*Voltage Setting:14.2V

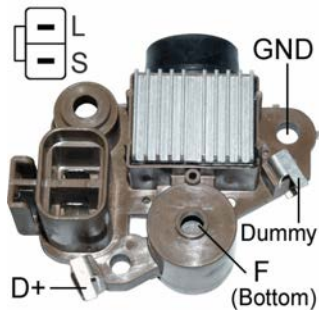

**Replaces**

**VALEO :**

M903

**Unit no.**

VALEO

TA000A48401

TA000A48402

**VR-MD07**

\*S-L Terminals  
 \*A-Circuit  
 \*Active L Terminal  
 \*Repair Circuit: VR-MD07S  
 \*Voltage Set Point:14.4V

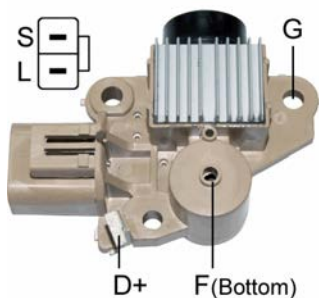

**Replaces**

**KIA :**

0K2A2-18-W63

**VALEO :**

231425

**Unit no.**

MANDO

AB170094

**VR-MD08**

\*Voltage Set Point:14.4V

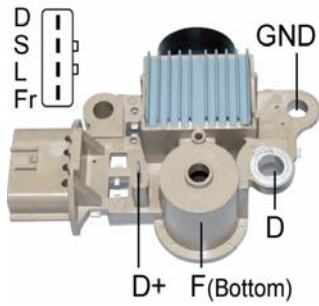

**Replaces**

**HYUNDAI :**  
37370-38310

**Unit no.**

HYUNDAI  
37300-39600  
MANDO  
AB112145

**VR-MD12**

\*Voltage Set Point: 14.5V

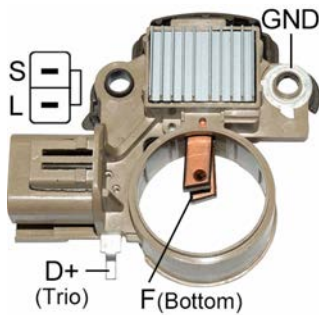

**Unit no.**

HYUNDAI  
37300-42353      37300-42355      37300-42451  
MANDO  
AF111364

**Used On**

<b>HYUNDAI</b>	
Satellite 2.5L Turbo Dsl.	1997-2002
Starex 2.5L Turbo Dsl.	1997-2012
H-1 2.5L Turbo Dsl.	1997-2012
<b>SUBARU</b>	
Libero	

**TB-M001**

\*Terminal Block



Unit no.

CHRYSLER	
04801490AA	4801490AA
MITSUBISHI	
A2TX0281	A2TX0281ZC

**TB-M146**

\*Terminal Block

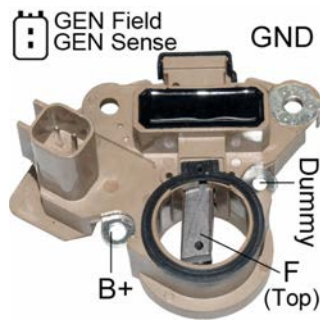

Unit no.

MITSUBISHI			
A2TJ0481	A2TJ0481ZC	A002TJ0481ZC	A3TJ2581

**VR-H2009**

\*A-Circuit  
 \*R-L Terminals  
 \*Voltage Set Point:14.7V

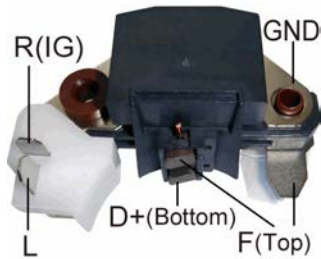

**Replaces**

**BOSCH :**

0-986-192-016

**FORD :**

E27Z-10316A

**LUCAS :**

21513103 UCJ200

**MAGNETI MARELLI :**

940038076

**MAZDA :**

8173-18-300 8173-24-520 N221-24-520

**MITSUBISHI :**

A866T00470 A866T00670 A866T01970 A866T02570 A866T02770 A866T03270

**MITSUBISHI MOTORS :**

MD607372 MD607570

**Unit no.**

**MAZDA**

1480-18-300	8173-18-300	8173-18-300B	8341-18-300	8356-18-300	D501-18-300
E301-18-300C	E301-18-300D	E302-18-300	E563-18-300A	FE01-18-300B	GE01-18-300
HE41-18-300	HE45-18-300	N221-18-300			

**MITSUBISHI**

A1T23377	A1T25191	A1T31371	A1T31699	A2T12371	A2T16471
A2T16471A	A2T16871	A2T16874	A2T23171	A2T23271	A2T23277
A2T23471	A2T23474	A2T23477	A2T24771	A2T25170	A2T25171
A2T26072	A2T26172	A2T31677	A2T40377	A2T41191	A2T41371
A2T41377	A2T46172	A3T21278	A3T21371	A3T32772	A3T32877
A3T34572	A3T34672	A3T34677	A4T25172	A4T25199	A4T30399
A5T15171	A5T15371	A5T15471	A5T15584	A5T20374	A5T20377
A5T20484	A5T20571	A5T21071	A5T21077	A5T21471	A5T22484
A5T23277	AQ2240K1	AQ2245G	AQ2245G1	AQ2245G7	AQ2245K1
AQ2250G1	AQ2250K1	AQ2250K7			

**MITSUBISHI MOTORS**

MD006187	MD007509	MD009052	MD009053	MD009054	MD018230
MD022572	MD022578	MD022579	MD025215	MD025677	MD025679
MD034130	MD034132	MD041700	MD060901	MD061818	MD062007
MD063781	MD064066	MD064067	MD064068	MD086046	MD086047
MD086048	MD104744				

**VR-H2009-1**

\*24V  
 \*Voltage Set Point:28.3V

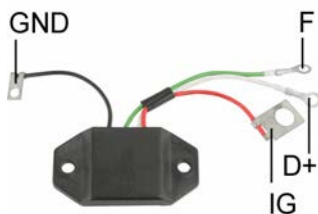

**Replaces**

**MITSUBISHI :**

3Y6693 R008T10471 R008T10472



**VR-H2009-100**

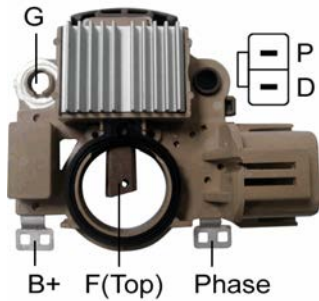

\* P-D Terminals  
 \* Short Circuit Protection  
 \*\*\*Traditional test method will immediately damage P-D regulator. Avoid damage using Mobiletron VR-H2009-66TF test fixture.

**Replaces**

**MAZDA :**  
 GY01-18-W70  
**MITSUBISHI :**  
 444                      465                      A866X46572

**Unit no.**

MAZDA  
 GY01-18-300E      GY01-18-300R  
 MITSUBISHI  
 A3TB1081            A3TB1081A

**VR-H2009-102**



\*AS-RC-LI Terminals  
 \*Voltage Set Point:14.0V  
 \*Regulated Voltage Control(RVC)  
 \*Used on Ford Mondeo and Escape 2.0  
 \*Requires RVC01 tester box for testing

**Replaces**

**MITSUBISHI :**  
 A866X50372      503

**Unit no.**

FORD  
 2S6T-10300DB      2S6U-10300GB  
 MITSUBISHI  
 A003TG5591ZC      A5TA7792

**VR-H2009-103**

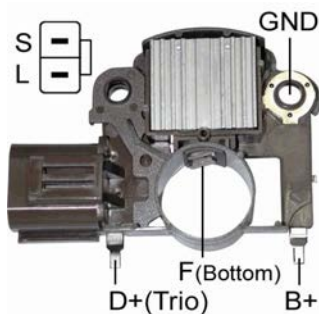

\*S-L Terminals  
 \*Repair Circuit:VR-H2009-11S  
 \*Voltage Set Point:14.6V  
 \*w/o Drive Choke

**Replaces**

**MITSUBISHI :**  
 145                      A866X14570                      A866X14572

**Unit no.**

MITSUBISHI  
 A005T03092            A005T03192            A5T00192

**VR-H2009-105**

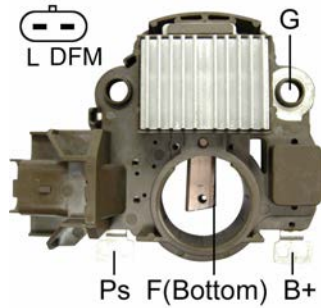

- \* L-DFM Terminals
- \* Soft Start
- \* 3.5 sec LRC
- \* L Terminal Drive Choke
- \* Repair Circuit:VR-H2009-105S
- \* Voltage Set Point:14.5V

**Replaces**

**MITSUBISHI :**

A866X49872      498

**Unit no.**

CITROEN

9638275880

MITSUBISHI

A5TA6291

A1TA3391

A1TA3392C

A5TA6291

A5TA6291A

A5TA6291C

A5TA6292

A5TA6292C

A5TA6292F

A005TA6291G

**VR-H2009-105SE**

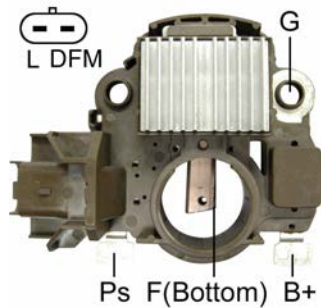

- \* L-DFM Terminals
- \* Soft Start
- \* 2.5 sec LRC
- \* Self Exciting
- \* L Terminal Does Not Drive Choke
- \* Voltage Set Point:14.5V

**Replaces**

**MITSUBISHI :**

506

**Unit no.**

CITROEN

9640088080

MITSUBISHI

A5TA6391

A5TA6292G

A5TA6391A

A5TA6391B

A5TA6391C

A5TA6392C

A003TB2691G

A003TB2691H

**VR-H2009-107**

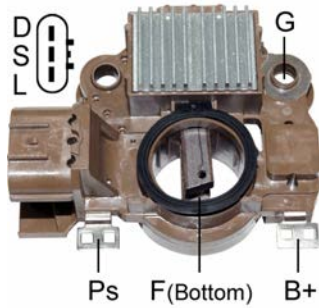

\* D-S-L Terminals  
 \* Voltage Set Point:14.4V

**Replaces**

**SUBARU :**

23815-AA150      23815-AA140

**Unit no.**

**MITSUBISHI**

A3TG2391      A2TB6291      A002TB2891      A002TB2891ZC      A002TB2991      A002TB6291

A2TB2891      A2TB2891ZC

**SUBARU**

23700-AA430      23700-AA55A

**VR-H2009-108**

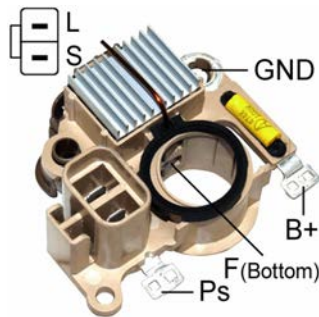

\*S-L Terminals  
 \*Soft Start  
 \*Short Circuit Protection  
 \*Repair Circuit:VR-H2009-115S  
 \*Voltage Set Point:14.5V

**Unit no.**

**FORD**

XF52-10300AC      XF5Z-10346AA

**MITSUBISHI**

A3TA5691

**NISSAN**

23100-7B000

**VR-H2009-109**

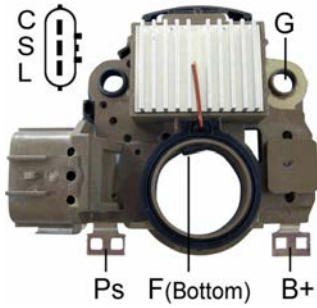

- \*C-S-L Terminals
- \*Voltage Set Point:14.5V
- \*Soft Start
- \*Short Circuit Protection

**Replaces**

**MITSUBISHI :**  
A3TB1891            A866X47272  
**SUBARU :**  
23815-AA160

**Unit no.**

MITSUBISHI  
A2TB3091            A2TB5391            A3TB1891  
SUBARU  
23700-AA380        23700-AA420

**VR-H2009-10A**

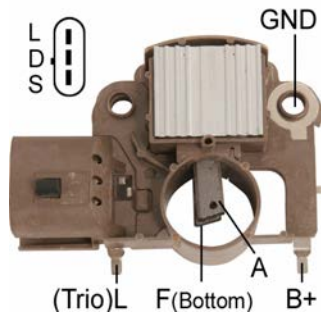

- \*I-S(D)-A Terminals
- \*Repair Circuit:VR-H2009-10AS
- \*Voltage Set Point:14.6V

**Replaces**

**FORD :**  
E8PZ-10316B        GRE793  
**MITSUBISHI :**  
A866X13970        A866X13971

**Unit no.**

FORD  
E83F-10300AA    E83F-10300AB    E83F-10300BA    E83Z-10346A    E8DF-10300AB    E8DZ-10346A  
MITSUBISHI  
A3T01596MA    A3T01598MA    A3T01598NA

**VR-H2009-110**

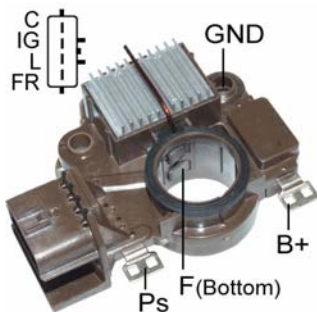

- \*C-IG-L-FR Terminals
- \*Soft Start
- \*Short Circuit Protection
- \*Voltage Set Point:14.5V

**Replaces**

**MITSUBISHI :**  
A866X44472        590

**Unit no.**

MITSUBISHI  
A1TA1891            A1TA1891A            A1TA1991            A1TA2491            A1TG0091            A5TG0991



**VR-H2009-113**

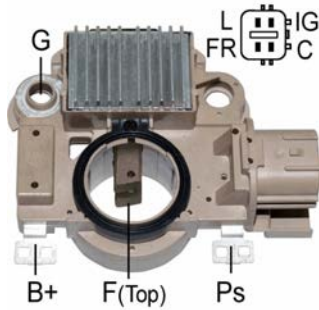

- \*IG-C-L-FR Terminals
- \*Inactive Lamp
- \*Soft Start
- \*4 sec LRC
- \*Short Circuit Protection
- \*Voltage Set Point:14.5V

**Replaces**

**HONDA :**

31150-RNA-A01

**MITSUBISHI :**

558                      A866X55852

**Unit no.**

**HONDA**

31100-RNE-A01      31100-RNE-A010M/AHGA75

**MITSUBISHI**

A002TC1591	A002TC1591ZC	A002TC1591ZCKD	A2TC1591	A2TC1591ZC	A2TC1591ZCKD
A2TC1391	A2TC1391ZC				

**Used On**

**HONDA**

Civic 4Cyl. 1.8L

2006-2011

**VR-H2009-114**

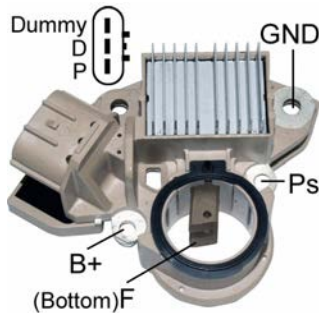

- \*Inactive Lamp
- \*W/Capacitor 2.2uF
- \*Works with PCM
- \*\*Traditional test method will immediately damage P-D regulator. Avoid damage using Mobiletron VR-H2009-66TF test fixture.

**Replaces**

**MITSUBISHI :**

A866X50572      505

**Unit no.**

**MAZDA**

AJ51-18-300	AJ57-18-300A	AJ51-18-W70	LFB6-18-300	L3M6-18-300A	L3M6-18-300B
-------------	--------------	-------------	-------------	--------------	--------------

**MITSUBISHI**

A3TJ1191	A2TJ0391	A3TJ0191	A3TJ0291
----------	----------	----------	----------

**Used On**

**MAZDA**

CX-7 2.3L

2007-2008

Van 2.5L

2012-

**VR-H2009-115**

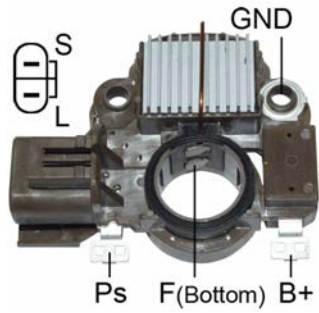

- \* S-L Terminals
- \* Inactive Lamp
- \* Short Circuit Protection
- \* S Open Lamp On
- \* Voltage Set Point:14.5V

**Replaces**

**MITSUBISHI :**

350                      626                      A866X35072                      341                      435                      A866X34272

**SUBARU :**

23815-AA090

**Unit no.**

GM

92058857

MITSUBISHI

A2TA7591                      A2TA7691

NISSAN

23100-0Y710                      23100-65F17

SUBARU

23700-AA280

**Used On**

**SUBARU**

Forester	2.5L	1998-
Impreza	1.8L	1997-
Impreza	2.2L	1997-1998

**VR-H2009-117**

\*Voltage Set Point: 14.5V

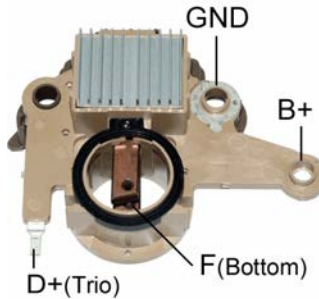

**Replaces**

**JDWP :**

JFZ1913

**Used On**

**CHERY**

Chery

**VR-H2009-118**

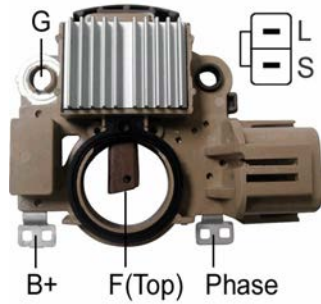

- \*S-L Terminals
- \*Short Circuit Protection
- \*S Open Lamp On
- \*Voltage Set Point:14.5V

**Replaces**

**MITSUBISHI :**  
 A866X36272      A866X42972      429  
**NISSAN :**  
 23215-0M011

**Unit no.**

MITSUBISHI  
 A2TB0491      A2TB3891      A2T33593B  
 NISSAN  
 23100-0M010      23100-6T012      23100-4M610      23100-4M611

**VR-H2009-119**

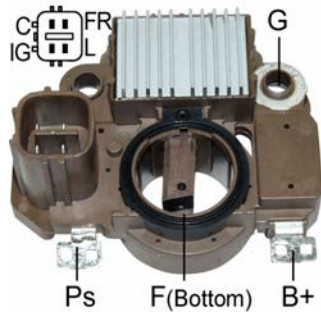

- \*Inactive Lamp
- \*C-FR-IG-L Terminals
- \*Soft Start
- \*4 sec. LRC
- \*Short Circuit Protection
- \*Voltage Set Point:14.5V

**Unit no.**

HONDA  
 31100-RSH-004  
 MITSUBISHI  
 A5TB1391

**Used On**

**HONDA**  
 Fit 1.5L

2007-2008



**VR-H2009-11H**

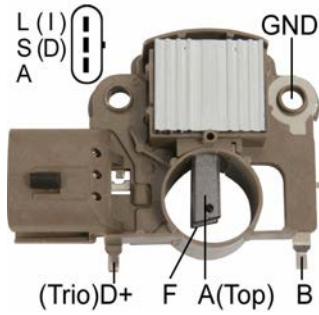

\*I-S(L/IG)-A Terminals  
 \*Repair Circuit:VR-H2009-11S  
 \*Voltage Set Point:14.6V

**Replaces**

**FORD :**

E8PZ-10313A      E8PZ-10316A      GRE792

**MITSUBISHI :**

A866X14072

**MOTORCRAFT :**

GRE317

**Unit no.**

**FORD**

E8SF-10300AA      E8SZ-10346A

**MITSUBISHI**

A3T01496      A3TO1496MA

**MOTORCRAFT**

GLE-254

**VR-H2009-12**

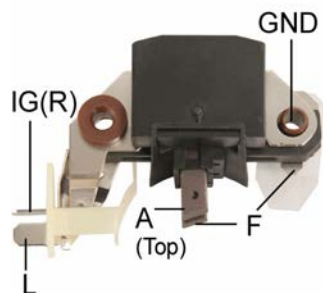

\*24V  
 \*R-L Terminals  
 \*Voltage Set Point:28.3V

**Replaces**

**MITSUBISHI :**

A866T06670

**MITSUBISHI MOTORS :**

ME700571

**Unit no.**

**MITSUBISHI**

A5T70178      A5T70183      A5T70283      A5T70383

**MITSUBISHI MOTORS**

ME007578      ME017560      ME017561      ME049165

**VR-H2009-120**

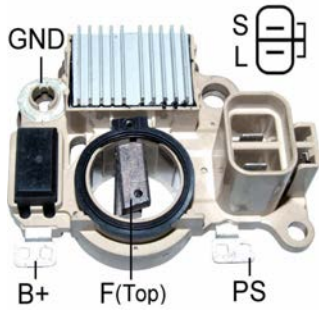

- \*A-Circuit
- \*Inactive Lamp
- \*Short Circuit Protection
- \*S Open Lamp On
- \*Voltage Set Point: 14.5V

**Replaces**

**MITSUBISHI :**

A866X39183      A866X47172      A866X39172      391

**Unit no.**

**MITSUBISHI**

A3T09678A      A3T09698A      A3T09798A      A3TA3098A      A3TA4298A      A3TA6098A  
 A3TB1999      A3TB19999KD      ME202755      ME203546      A7TA3377

**NISSAN**

23100-FU410

**VR-H2009-121**

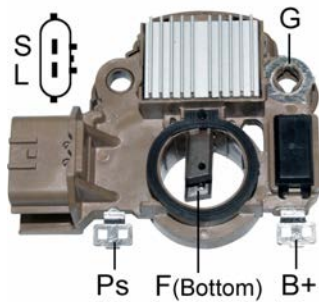

- \*Soft Start
- \*Short Circuit Protection
- \*Voltage Set Point: 14.4V

**Unit no.**

**NISSAN**

23100-2Y005

**VR-H2009-122**

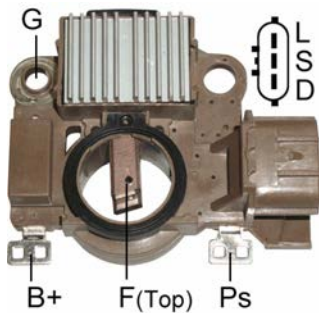

- \*Soft Start
- \*5 sec. LRC
- \*Short Circuit Protection
- \*Voltage Set Point: 14.4V

**Replaces**

**MITSUBISHI :**

A866X56672      566

**Unit no.**

**MITSUBISHI**

A3TG2681AE      A2TG1581      A2TG1581AC

**NISSAN**

23100-ZW40B      23100-EB31A

**VR-H2009-123**

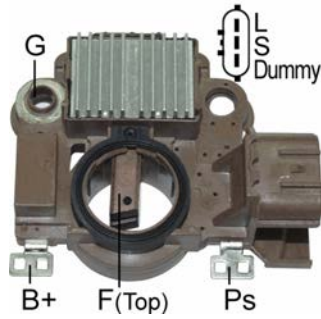

\*Short Circuit Protection  
\*Voltage Set Point: 14.5V

Unit no. [Redacted]  
MITSUBISHI  
A2TG-1081ZT  
NISSAN  
23100-EB71A

**VR-H2009-125B**



\*24V  
\*Voltage Set Point:28.3V

**Replaces** [Redacted]  
**MITSUBISHI :**  
576  
Unit no. [Redacted]  
MITSUBISHI  
A004TA8191      A4TA8191

**VR-H2009-126**

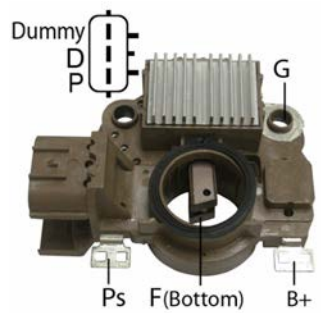

\*Inactive Lamp  
\*Dummy-D-P Terminals  
\*Voltage Set Point:14V  
\*Work with PCM  
\*\*\* Traditional test method will immediately damage P-D regulator. Avoid damage using Mobiletron VR-H2009-66TF test fixture.

**Replaces** [Redacted]  
**MITSUBISHI :**  
561  
Unit no. [Redacted]  
MAZDA  
ZJ38-18-300  
MITSUBISHI  
A3TG5691      A3TB6581      A3TB6781      A2TG1391      A002TG1391

**VR-H2009-128**

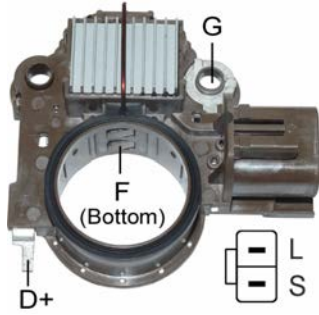

\*L-S Terminals  
\*Voltage Set Point: 14.5V

**Replaces**

**HYUNDAI :**  
37370-42300  
**VALEO :**  
235551

**Unit no.**

HYUNDAI					
37300-4A001	37300-4A002	37300-4A003	37300-4A110	37300-42456	37300-42459
37300-42360	37300-4A111				
MANDO					
AF111225	AF111382	AF111390	AF111393	AF175476	
VALEO					
TA000A48201	TA000A54701	TA000A56901	TA000A57301	TA000A57401	

**Used On**

<b>HYUNDAI</b>	
Commercial H1 2.5	2003-2006
Commercial H200 2.5	2003-2006
Satellite 2.5L T DSL	1997-ON
H1 2.5L T DSL	1997-ON
Starex 2.5L T DSL	1997-ON

**VR-H2009-129**

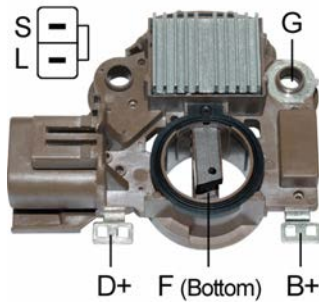

\*S-L Terminals  
\*Voltage Set Point: 14.5V

**Replaces**

<b>MAZDA :</b>					
B307-18-W70	B3C7-18-W70	JE48-18-W70			
<b>MITSUBISHI :</b>					
A866X38072	A866X24072	A866X20572	A866X24082	A866X25372	A866X27472

**Unit no.**

MITSUBISHI		
A3TA2391A	A3TA2391	
MITSUBISHI MOTORS		
MD313384	MD318460	MD354804

**VR-H2009-130**

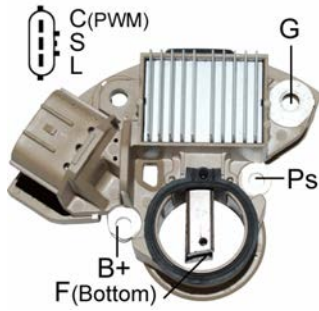

- \*Soft Start
- \*5 sec LRC
- \*W/Capacitor 2.2uF
- \*Short Circuit Protection
- \*Voltage Set Point: 14.5V
- \*Regulated Voltage Control(RVC)
- \*Requires RVC01 tester box for testing

**Replaces**

**MITSUBISHI :**

A866X68272      A866X54779      A866X54762      682      547

**Unit no.**

**MITSUBISHI**

A3TJ0691      A3TJ0781      A2TJ0581      A3TJ1791      A3TJ1791ZC      A003TJ3691  
 A3TJ3691      A3TJ3691ZC

**NISSAN**

23100-JA11B      23100-1FC1A      23100-1AA1A      23100-JA11A      23100-JA11AR      23100-EB315  
 23100-EG010

**Used On**

**INFINITI**

M35 3.5L      2006-2008

**NISSAN**

Navara 2.5 dCi      2005-  
 Navara 2.5 dCi 4WD      2006-  
 Pathfinder 2.5      2006-2007  
 Pathfinder 2.5 4WD      2005-2006  
 Altima 6Cyl. 3.5L      2007-2013

**VR-H2009-132B**



- \*24V
- \*S Open Lamp On
- \*Voltage Set Point: 28.3V

**Replaces**

**MITSUBISHI :**

553

**Unit no.**

**MITSUBISHI**

A4TR5894ZT      A4TR5591ZT

**VR-H2009-132BA**

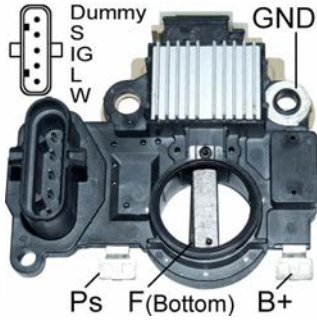

- \*24V
- \*S Open Lamp On
- \*Voltage Set Point: 28.3V
- \*w/plastic cover, insulated plate, protect cover for welding

**Replaces**

**MITSUBISHI :**  
553

**Unit no.**

MITSUBISHI  
A4TR5894ZT      A4TR5391

**VR-H2009-135B**

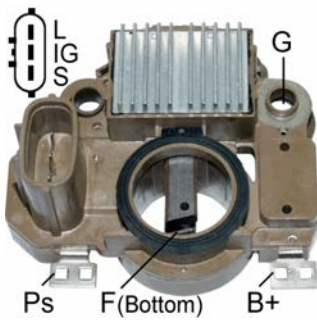

- \*24V
- \*L-IG-S Terminals
- \*Voltage Set Point:28.3V

**Unit no.**

MITSUBISHI  
A4TA0591      A4TA0592      A4TA0594      A4TA8291      A4TA8292

**VR-H2009-139**

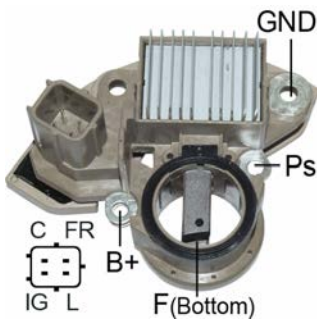

- \*C-FR-IG-L Terminals
- \*Soft Start
- \*7 sec. LRC
- \*W/Capacitor 2.2uF
- \*Voltage Set Point:14.5V

**Replaces**

**MITSUBISHI :**  
605

**Unit no.**

HONDA  
31100-RB0-004      31100-RB0-0041      31100-RB0A-0243      AHGA77  
MITSUBISHI  
A5TJ0091

**Used On**

**HONDA**  
Fit 4 Cyl. 1.5L

2009-2012



**VR-H2009-144**

Dummy FR

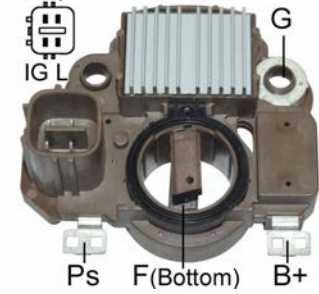

- \*Soft Start
- \*5 sec. LRC
- \*Short Circuit Protection
- \*Voltage Set Point: 14.5V

**Replaces**

**HONDA :**  
31150-REA-Z01  
**MITSUBISHI :**  
513

**Unit no.**

HONDA  
31100-REA-Z01 AHGA58  
MITSUBISHI  
A5TB0291ZD

**Used On**

**HONDA**  
Fit 2004-2007  
Jazz 2004-2007

**VR-H2009-145**

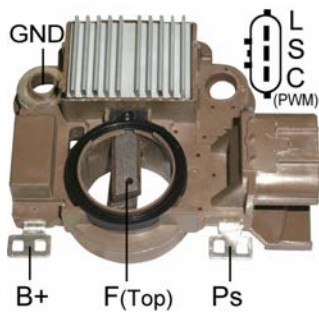

- \*C-S-L Terminals
- \*Voltage Set Point:14.5V
- \*Soft Start
- \*5 sec. LRC
- \*Short Circuit Protection
- \*Regulated Voltage Control (RVC)
- \*Requires RVC01 tester box for testing

**Replaces**

**MITSUBISHI :**  
A866X54472 547 544

**Unit no.**

MITSUBISHI  
A3TG2681ZE A3TG5381RL A003TG5381RL  
NISSAN  
23100-EB310

**Used On**

**NISSAN**  
Navara 2.5 dCi



**VR-H2009-147**

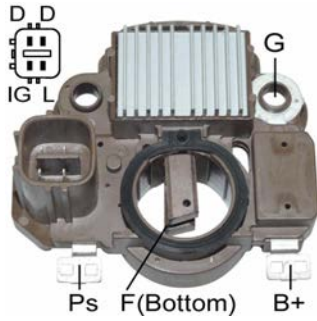

- \*Soft Start
- \*8 sec. LRC
- \*Short Circuit Protection
- \*Voltage Set Point:14.6V

**Replaces**

**MITSUBISHI :**

548

**SUZUKI :**

32500-61J00

Unit no.

SUZUKI

31400-61J00

**VR-H2009-148**

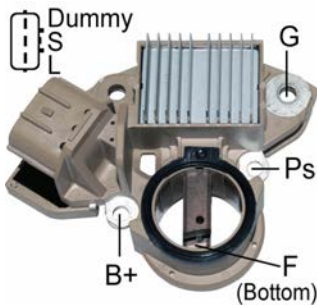

- \*Soft Start
- \*5 sec LRC
- \*W/Capacitor 0.5uF
- \*Short Circuit Protection
- \*Voltage Set Point:14.5V

**Replaces**

**MITSUBISHI :**

564

Unit no.

MITSUBISHI

A2TJ0281

A2TJ0281ZC

A2TJ0291

A2TJ0291ZC

A002TJ0281

NISSAN

23100-EM01A

23100-EM01B

23100-EM01BR

23100-JD200

23100-JN81A

**Used On**

**NISSAN**

Sentra 4Cyl. 2.0L

2007-2010

Versa 4Cyl. 1.8L

2007-2009

**VR-H2009-14N**

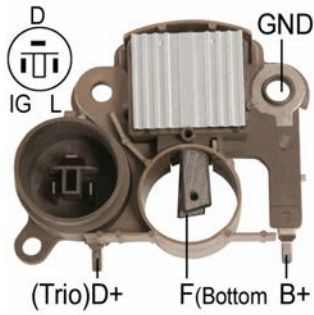

\*D-IG-L Terminals  
 \*Repair Circuit:VR-H2009-14NS  
 \*Voltage Set Point:14.6V  
 \*w/o Drive Choke

**Replaces**

**MITSUBISHI :**  
 A866X11870  
**SUZUKI :**  
 32500-60A10

**Unit no.**

MITSUBISHI  
 A1T03191            A1T03195  
 SUZUKI  
 31400-60A20

**VR-H2009-15**

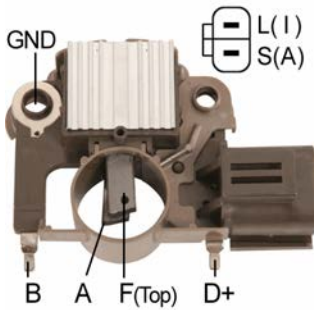

\*I-A Terminals  
 \*Repair Circuit:VR-H2009-15S  
 \*Voltage Set Point:14.5V

**Replaces**

**FORD :**  
 E9PZ10316AA  
**MITSUBISHI :**  
 A866X13272            A866X15170            A866X17470            A866X21472            A866X19172            A866X20782  
 A866X21472            A866X21482  
**NISSAN :**  
 23215-35F10            23215-64J11            23215-64J12

**Unit no.**

FORD  
 E9DF-10300BB            E9PZ-10316A  
 MITSUBISHI  
 A2T02394            A2T05192            A2T13894            A2T14694            A2T18792            A2T48195  
 A3T00491            A3T12691  
 MOTORCRAFT  
 GLE-261            GRE-796  
 NISSAN  
 23100-12C10            23100-15P11            23100-31P10            23100-35F10            23100-65E10

**VR-H2009-151B**

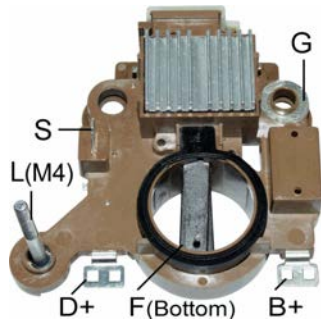

\*24V  
\*Voltage Set Point: 28.7V

Unit no.

MITSUBISHI			
A4TR5191	A4TR5188	A4TR5191ZT	A4TR5191
SCANIA			
1516176	1525447		

**VR-H2009-152**

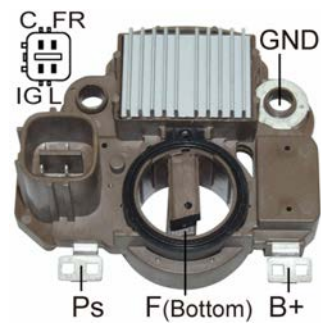

\*C-FR-IG-L Terminals  
\*Soft Start  
\*Short Circuit Protection  
\*Voltage Set Point: 14.5V

Replaces

MITSUBISHI :  
438

Unit no.

HONDA	
31100-PEJ-004	AHGA35
MITSUBISHI	
A5TA4591	A5TA3591

Used On

HONDA	
Civic 1.6L	1999-2000
Logo 1.3L	1999-2002

**VR-H2009-153**

\*Voltage Set Point: 14.3V

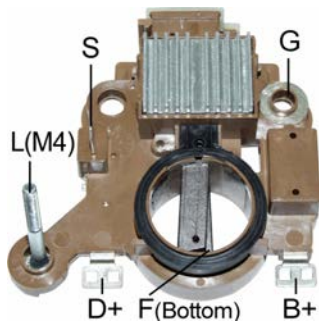

**Replaces**

MITSUBISHI :  
518

**Unit no.**

MITSUBISHI  
A3TR0091      A3TR0093      A3TR0094      A3TR0091ZT      A3TR0093ZT      A3TR0094ZT

**Used On**

**VOLVO**

- Penta D1-13
- Penta D1-20
- Penta D1-30
- Penta D2-40
- Penta D2-55
- Penta D2-75
- Penta D4-250
- Penta D6-310
- D6-435

**VR-H2009-154B**

\*24V  
\*Voltage Set Point: 28.5V

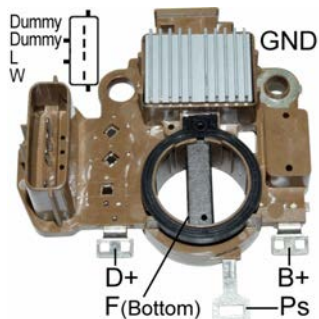

**Replaces**

MITSUBISHI :  
514

**Unit no.**

MITSUBISHI  
A4TR5091ZT      A4TR5091  
RENAULT  
5001866377      5010480765





## VR-H2009-164

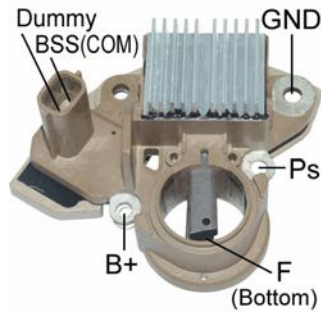

\*BSS connections  
\*Requires COM01 test adaptor for testing

### Replaces

**MITSUBISHI :**  
551

### Unit no.

MITSUBISHI			
A004TJ0282	A004TJ0282ZE	A4TJ0282	A4TJ0281
RENAULT			
8200654786	8200404465	8200654785	8200960536

## VR-H2009-168

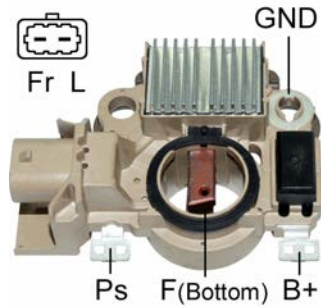

\*Soft Start  
\*5 sec LRC  
\*Short Circuit Protection  
\*Voltage Set Point:14.5V

### Replaces

**MITSUBISHI :**  
533

## VR-H2009-169

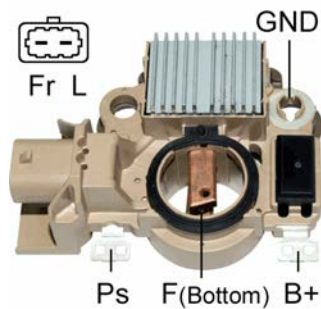

\*Fr-L Terminals  
\*Soft Start  
\*2.5 sec LRC  
\* Voltage Set Point:14.5V

### Unit no.

MITSUBISHI		
A003TG1581	A3TG1581	A3TG1991

### Used On

**PONTIAC**  
GTO 8 Cyl. 6.0L

2005-2006

**VR-H2009-17**

\*24V  
\*Voltage Set Point:28.3V

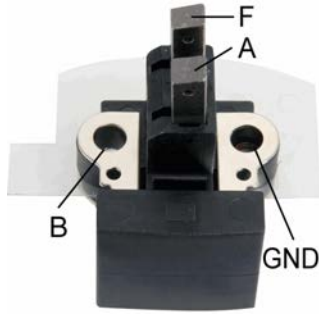

**Replaces**

**MITSUBISHI :**  
A866T01070      A866X01070  
**MITSUBISHI MOTORS :**  
ME700091

**Unit no.**

MITSUBISHI

A2T61571	A2T61871	A2T61971	A2T70571	A2T70671	A2T70771
A2T70772	A2T70774	A2T71183	A2T71478	A2T71483	A2T71578
A2T71583	A2T71683	A2T71978	A2T71983	A3T68071	A3T76071
A3T76072	A3T76073	A3T76075	A3T77071	A4T56771	A4T56772
A4T56773	A4T56871	A4T57371	A4T57471	A4T57472	A4T65571
A4T65671					

MITSUBISHI MOTORS

ME007396	ME007397	ME007533	ME007540	ME007550	ME017507
ME017509	ME017516	ME017550	ME017552	ME017553	ME037370
ME037371	ME037372	ME037481	ME037482	ME037593	ME067611
ME067614	ME067617	ME067630	ME067631	ME067632	ME067635
ME067640	ME067641	ME067642	ME067644		



**VR-H2009-170**

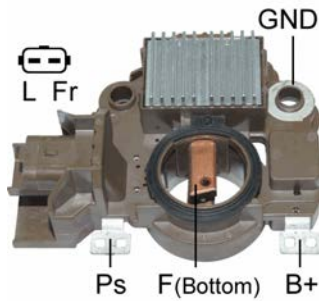

- \* L-Fr Terminals
- \* Soft Start
- \* 3.5 sec LRC
- \* Short Circuit Protection
- \* Self Exciting
- \* Voltage Set Point:14.5V

**Replaces**

**MITSUBISHI :**  
606

**Unit no.**

CITROEN  
9642124980  
MITSUBISHI  
A003TB2691K    A3TB2691K    A003TB2691J    A3TB2691

**Used On**

**CITROEN**

Berlingo LCV 1400	2008-2012
Berlingo LCV 1600 16V	2008-2012
C4 1400 16V	2004-2010
C4 1600 16V	2004-2010
C5 1800 16V	2001-2010
C5 2000 16V	2001-2004

**PEUGEOT**

207 1400 16V	2008-2012
407 2200 16V	2004-2010
807 2200 16V	2002-2010
807 2200 16V	2002-2010

**VR-H2009-171**

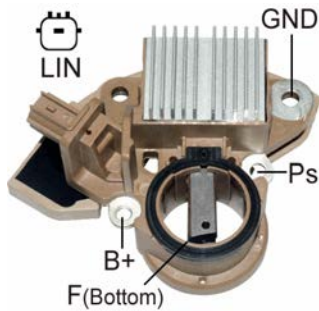

- \* Voltage Set Point: 14.5V
- \* LIN-2
- \* 2400~19200 Baud Rate (4 Byte)
- \* Requires COM01 test adaptor for testing

**Replaces**

**HONDA :**  
31150-R1A-A01

**MITSUBISHI :**  
667

**Unit no.**

HONDA  
31100-R1A-A01  
MITSUBISHI  
A005TJ0191    A5TJ0191    A5TJ0191ZC    A005TJ0191ZD    A005TJ0191ZE    A5TJ0191ZE  
AHGA81    A5TJ0191ZD

**Used On**

**ACURA**

ILX L4 2.0L	2013-2014
-------------	-----------

**HONDA**

Civic L4 1.8L	2012-2014
---------------	-----------

**VR-H2009-172**

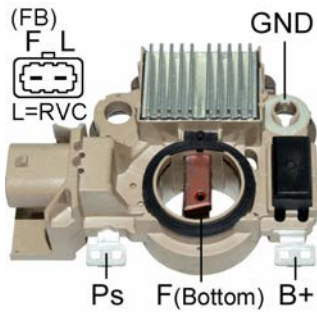

- \*Soft Start
- \*4 sec. LRC
- \*Short Circuit Protection
- \*Voltage Set Point: 13.8V
- \*Regulated Voltage Control(RVC)
- \*Requires RVC01 tester box for testing

**Replaces**

**MITSUBISHI :**  
598

**Unit no.**

MITSUBISHI  
A3TG4091      A3TG4191      A3TG1591      A3TG1491

**Used On**

**POCLAIN**

G8 V6 3.6L 2008-2009

**PONTIAC**

G8 V8 6.0L 2009-  
G8 V8 6.2L 2009-

**VR-H2009-173**

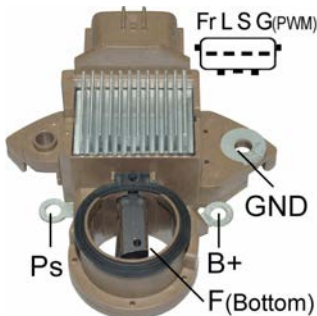

- \*Soft Start
- \*5 sec LRC
- \*Short Circuit Protection
- \*Voltage Set Point: 14.5V
- \*Regulated Voltage Control(RVC)
- \*Requires RVC01 tester box for testing

**Replaces**

**MITSUBISHI :**  
660

**Unit no.**

MITSUBISHI  
A2TX0881      A2TX0881A      A2TX1081

**VR-H2009-175**

\*Voltage Set Point: 14.5V

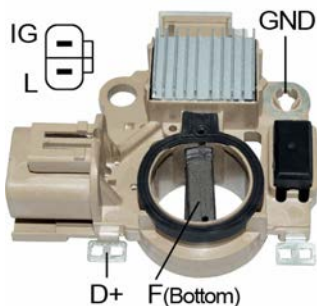

**Replaces**

**MITSUBISHI :**  
542

**Unit no.**

MITSUBISHI  
ME192608



**VR-H2009-18**

\*R-L Terminals  
\*Voltage Set Point:14.7V

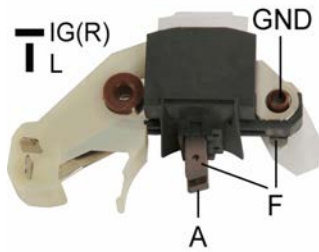

**Replaces**

**MAZDA :**

SE21-24-520

**MITSUBISHI :**

A866T03070      A866T03470      A866T18270

**MITSUBISHI MOTORS :**

MD607619

**Unit no.**

MAZDA

4813-18-300

MITSUBISHI

A1T32084      A2T15384      A2T43583      A5T22484

MITSUBISHI MOTORS

MD013740      MD072582      MD087246

**VR-H2009-180**

\*Soft Start  
\*5 sec LRC  
\*Short Circuit Protection  
\*Voltage Set Point:14.5V

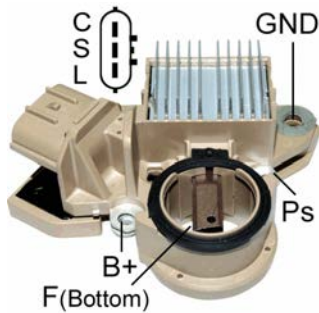

**Replaces**

**MITSUBISHI :**

594      686

**Unit no.**

MITSUBISHI

A3TJ3591      A003TJ3591

SUBARU

23700-AA620

**Used On**

**SUBARU**

Legacy 3.6L	2010-2011
Outback 3.6L	2010-2011
Tribeca 3.6L	2010-2011

**VR-H2009-182**

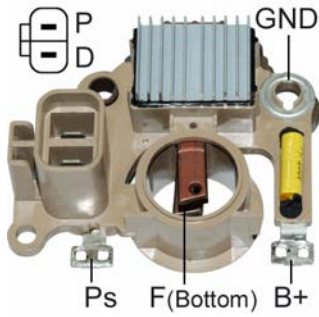

\*Inactive Lamp  
 \*Voltage Set Point: 14V  
 \*Work with PCM  
 \*\*\* Traditional test method will immediately damage P-D regulator. Avoid damage using Mobiletron VR-H2009-66TF test fixture.

Unit no. [Redacted]  
 MAZDA  
 F82M-18-300  
 MITSUBISHI  
 A2TC0591

**VR-H2009-183B**

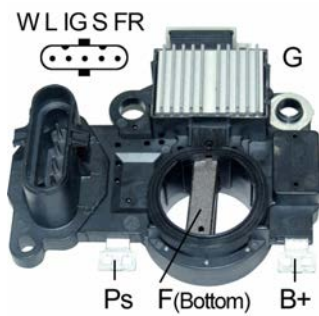

\*24V  
 \*S Open Lamp Off  
 \*IG Open Lamp On  
 \*Voltage Set Point: 28.3V

**Replaces** [Redacted]  
**MITSUBISHI :**  
 675                      565  
 Unit no. [Redacted]  
 MITSUBISHI  
 A004TR5491AT    A004TR6393ZT    A4TR5491

**VR-H2009-184**

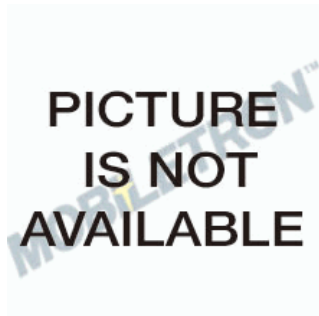

**Replaces** [Redacted]  
**MITSUBISHI :**  
 633  
 Unit no. [Redacted]  
 MITSUBISHI  
 A2TJ1381            A2TJ1191  
 NISSAN  
 23100-0028R

**VR-H2009-188**

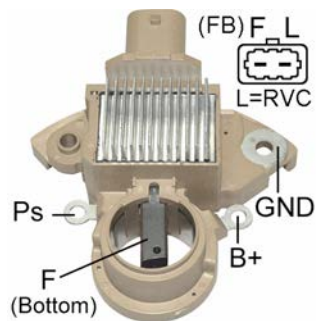

- \* Soft Start
- \* 4 sec. LRC
- \* Short Circuit Protection
- \* Voltage Set Point: 14.4V

Unit no.

MITSUBISHI  
A002TX1381

Used On

**FORD**  
Falcon

1998-2010

**VR-H2009-19**

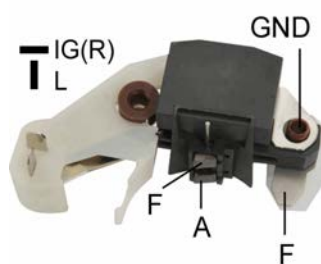

- \*24V
- \*R-L Terminals
- \*Voltage Set Point:28.3V

Replaces

**MAZDA :**  
SE17-24-520  
**MITSUBISHI :**  
A866T03570

Unit no.

MITSUBISHI  
A6T65199

**VR-H2009-191B**

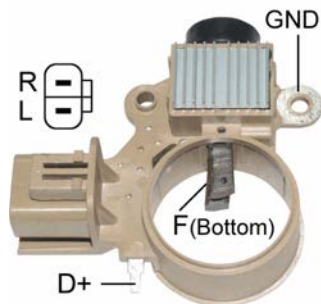

- \*Voltage Set Point: 28.4V

Replaces

**HYUNDAI :**  
37370-45100

Unit no.

HYUNDAI  
37300-45100      37300-45101

Used On

**HYUNDAI**  
Mighty 2



**VR-H2009-197B**

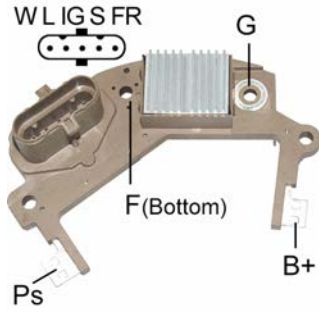

- \*24V
- \*Voltage Set Point: 28.3V
- \*Active Lamp
- \*S Open Lamp Off
- \*IG Open Lamp On

Unit no.

MITSUBISHI				
A9TU5591	A009TU5591A	A9TU5591A	A9TU5591ZT	A009TU5591ZT
SCANIA				
1777301	1536236	1777466		

Used On

SCANIA  
K-Series

**VR-H2009-198**

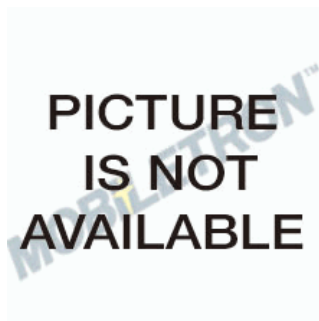

Replaces

MITSUBISHI :  
695

Unit no.

MITSUBISHI  
A2TX2581ZD

**VR-H2009-199**

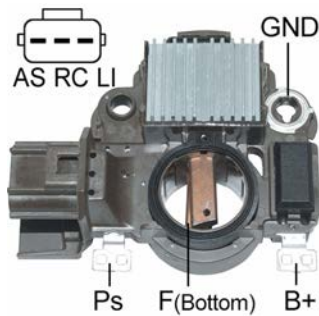

- \*Voltage Set Point: 14.2V
- \*Regulated Voltage Control(RVC)

Replaces

MITSUBISHI :  
628

Unit no.

MITSUBISHI  
A4A3F38062



**VR-H2009-20**

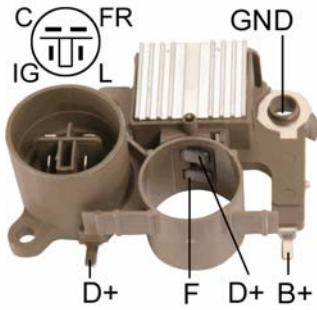

\*C-FR-IG-L Terminals  
 \*Repair Circuit:VR-H2009-20S  
 \*Voltage Set Point:14.6V

**Replaces**

**MITSUBISHI :**  
 A866T38570      A866X13670      A866X22072

**Unit no.**

HONDA  
 31100-AHG-A03  
 MITSUBISHI  
 A1T02291      A1T02292      A1T04892      A5T04072      A5T04092      A5T04292  
 A5T06291

**VR-H2009-201**

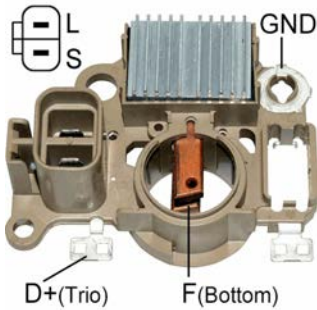

\*Voltage Set Point: 14.5V

**Replaces**

**MITSUBISHI :**  
 A866X32672      992

**Unit no.**

MITSUBISHI  
 A7T03371A      A7T03771A  
 NISSAN  
 23100-50K10

**VR-H2009-203**

PICTURE  
IS NOT  
AVAILABLE

**Replaces**

**MITSUBISHI :**  
A866X41072

**Unit no.**

HYUNDAI  
37300-45001  
MITSUBISHI  
A2TN1199A      A2TN1199AT      A2TN1798A      A2TN1798AT      A2T82899A      A3TN1281A  
MITSUBISHI MOTORS  
MD366051      MD366052

**Used On**

**MITSUBISHI**  
Pajero 2.5L      1990-1999

**VR-H2009-204**

PICTURE  
IS NOT  
AVAILABLE

**Unit no.**

HONDA  
31100-5R0-004      31100-5R7-A01      31100-5R7-A02      AHGA92      AHGA95  
MITSUBISHI  
A5TZ0091

**Used On**

**HONDA**  
Fit      2013-

**VR-H2009-205B**

\*24V

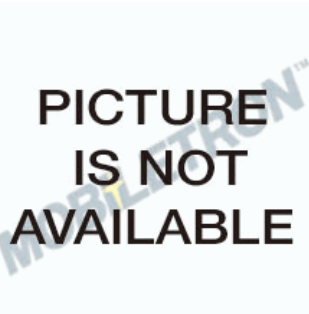

Unit no.

MITSUBISHI

A3TN5379

ME049321

A3TN5379ZC

ME08887

A3TN5399

ME017614

ME049281

A3TN5387

**VR-H2009-206**

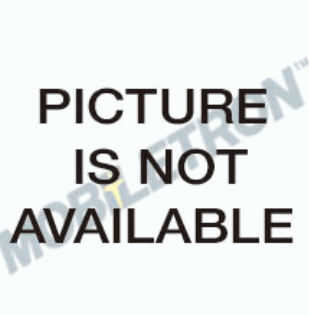

Unit no.

FORD

LK1S-7T10300AB

**VR-H2009-207B**

\*24V

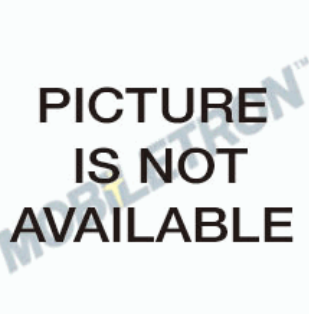

Unit no.

MITSUBISHI

A3TA8199

A003TA8199

MITSUBISHI MOTORS

ME108147

Used On

MITSUBISHI

Canter 2.8L

1996-1999

Canter 3.0L

1996-1999

**VR-H2009-208**

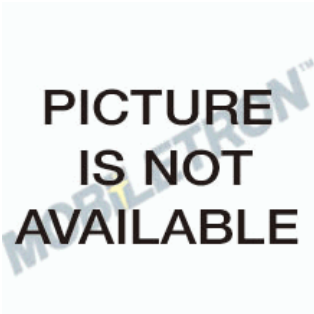

**Replaces**

**MITSUBISHI :**  
700

**Unit no.**

HONDA  
31100-5A2-A02  
MITSUBISHI  
A5TL0581ZC

**VR-H2009-21**

\*24V  
\*R-L Terminals  
\*Voltage Set Point:28.3V

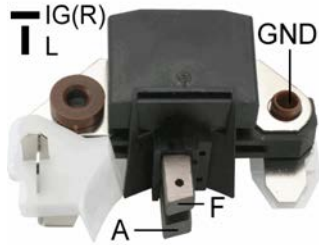

**Replaces**

**MITSUBISHI :**  
A866T02070

**Unit no.**

MITSUBISHI  
40Q                      A641                      T46070

**VR-H2009-210**

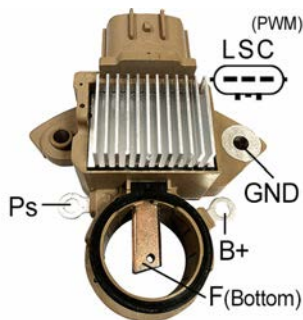

**Unit no.**

MITSUBISHI  
A2TL0091                      A002TL0091

**VR-H2009-212**

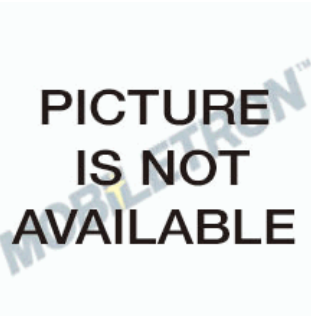

Unit no. \_\_\_\_\_  
 MITSUBISHI  
 A3TX1691

**VR-H2009-22**

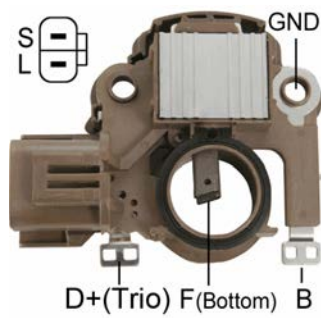

\*S-L Terminals  
 \*Repair Circuit:VR-H2009-43S  
 \*Voltage Set Point:14.5V

**Replaces**

<b>MAZDA :</b>			
B64J-18-W70	JE48-18-W70		
<b>MITSUBISHI :</b>			
A866X27772	A866X22772	A866X20472	A866X20972

Unit no. \_\_\_\_\_

FORD					
FS1118300A					
MAZDA					
B366-18-300	B3C7-18-300	B61P-18-300	B64J-18-300B	B665-18-300	FELC-18-300
FS05-18-300	JE48-18-300	K801-18-300	N3A1-18-300	RFG7-18-300	
MITSUBISHI					
A2T33191	A2T33891	A2T33991	A2T35177	A2T36578	A2T38977
A3T07592	A3T08491	A3T08591	A5T03391	A5T03677	A5T03777

**VR-H2009-23**

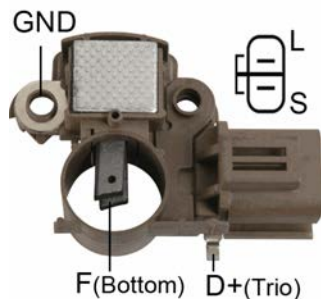

\*S-L Terminals  
 \*Repair Circuit:VR-H2009-7S  
 \*Voltage Set Point:14.6V

**Replaces**

**MITSUBISHI :**  
 A866X08472

**NISSAN :**  
 23215-58S10

**Unit no.**

MITSUBISHI		
A5R41592	A5T41592	A5T41592B
NISSAN		
23100-53A10	23100-53A11	

**VR-H2009-24**

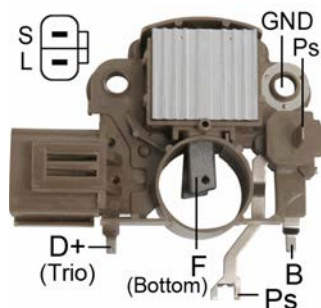

\*S-L Terminals  
 \*Repair Circuit:VR-H2009-10S  
 \*Voltage Set Point:14.5V

**Replaces**

**FORD :**  
 F0BZ-10316A

**MITSUBISHI :**  
 A866X17170      A866X17172

**Unit no.**

FORD		
F0CZ-10346B	FOBZ-10346A	
MAZDA		
B113-18-300B	BP02-18-300A	
MITSUBISHI		
A5T00877	A5T00972	A5T02777

**VR-H2009-25**

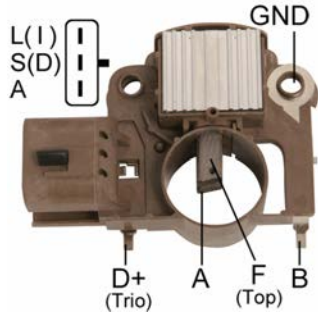

\*I-S(D)-A Terminals  
 \*Repair Circuit:VR-H2009-10AS  
 \*Voltage Set Point:14.5V

**Replaces**

**FORD :**  
 E9PZ-10316B  
**MITSUBISHI :**  
 A866X15472  
**MOTORCRAFT :**  
 GRE797

**Unit no.**

FORD  
 E9SF-10300DA E9SZ-10346A  
 MITSUBISHI  
 A4T00796  
 MOTORCRAFT  
 GLE-265

**VR-H2009-26**

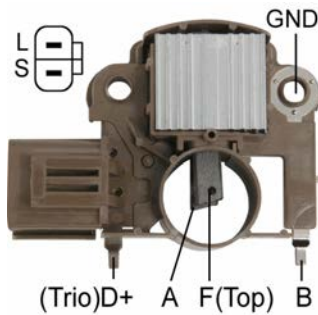

\*S-L Terminals  
 \*Repair Circuit:VR-H2009-10S  
 \*Voltage Set Point:14.5V

**Replaces**

**FORD :**  
 F02Z-10316A GRE799  
**MAZDA :**  
 F285-18-W70  
**MITSUBISHI :**  
 A866T17972 A866X00179 A866X17972 F28518W70A A866X09971 A866X09972  
 A866X09982 A866X14570 A866X14572 A866X17972 A866X17982  
**MOTORCRAFT :**  
 GRE799  
**NISSAN :**  
 F285-18-W70A 23215-77A10

**Unit no.**

MITSUBISHI  
 A002T19991 A002T34477 A003T06791 A2R20191 A2T17574 A2T19991  
 A2T20091 A2T20191 A2T20191ZC A2T21191 A2T34477 A3T08891  
 A5R01577 A5T01577 A5T01977 B36618300G F28518300C N39018300A

**VR-H2009-27**

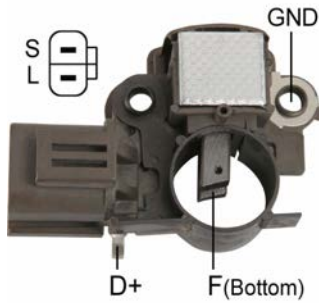

\*S-L Terminals  
 \*Repair Circuit:VR-H2009-7S  
 \*Voltage Set Point:14.6V

**Replaces**

**MITSUBISHI :**  
 A866X06470      A866X06471  
**NISSAN :**  
 23133-08E15      23313-08515

**Unit no.**

MITSUBISHI  
 A2T47794  
 NISSAN  
 23100-51S10

**VR-H2009-28**

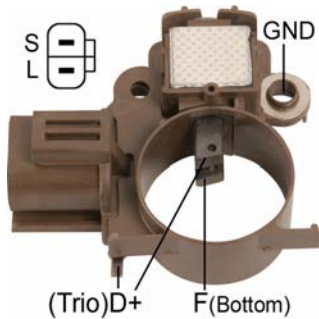

\*S-L Terminals  
 \*Repair Circuit:VR-H2009-5S  
 \*Voltage Set Point:14.6V

**Replaces**

**MITSUBISHI :**  
 A866T09170      A866X09170      A866X10271      A866X09171  
**MITSUBISHI MOTORS :**  
 MD611481      MD611668

**Unit no.**

MITSUBISHI  
 A2T01384      A2T01483      A2T01583      A2T01683      A2T01783      A2T02084  
 A2T06384      A2T09884      A2T10083      A2T14376      A2T14876      A2T27883  
 A2T49377  
 MITSUBISHI MOTORS  
 MD102864      MD102865      MD103372      MD103373      MD103564      MD106319  
 MD106320      MD106332      MD112318      MD124233      MD124234      MD127087  
 MD132130



**VR-H2009-3**

\*S-L Terminals  
\*Voltage Set Point:14.7V

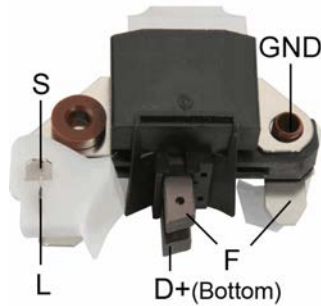

**Replaces**

- LUCAS :**  
21511095                    21511116                    UCJ207
- MAGNETI MARELLI :**  
940038075
- MAZDA :**  
8574-24-520
- mitsubishi :**  
A866T00870                A866T02970
- NISSAN :**  
23215-P3017                23215-W7110

**Unit no.**

MAZDA					
8574-18-300					
mitsubishi					
A1T22971	A1T25083	A2T24971	A2T40971	A3R40672	A3T21677
A3T33772	A3T40672	A5T20972	A5T21871		
NISSAN					
23100-01B10	23100-01B15	23100-01F10	23100-04M10	23100-10B10	23100-B9810
23100-D0211	23100-H7711	23100-P3017	23100-R9011	23100-W5811	

**VR-H2009-30**

\*S-L Terminals  
\*Voltage Set Point:14.4V

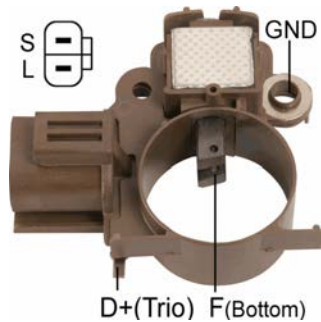

**Replaces**

- mitsubishi :**  
A866X12682
- mitsubishi MOTORS :**  
MD160671

**Unit no.**

mitsubishi				
A3T01877	A3T01877B	A3T04177	A3T04178	A3T05676

**VR-H2009-32**

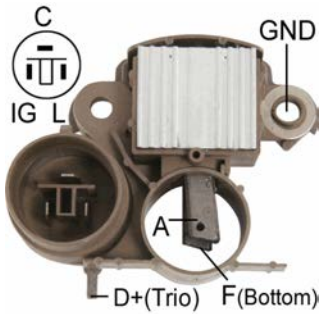

\*C-IG-L Terminals  
 \*Repair Circuit:VR-H2009-32S  
 \*Voltage Set Point:14.6V

**Replaces**

**HONDA :**

31150-PE0-9270

**MITSUBISHI :**

A866X08270      A866X08271

**Unit no.**

HONDA

31100-PE0-906      31100-PE0-9270

MITSUBISHI

A1T01691

**VR-H2009-33**

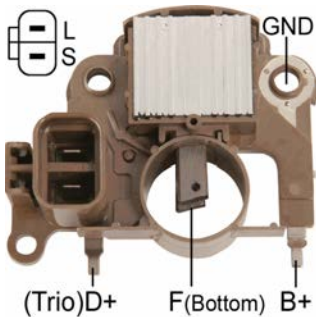

\*S-L Terminals  
 \*Repair Circuit:VR-H2009-10S  
 \*Voltage Set Point:14.5V

**Replaces**

**MAZDA :**

JE15-18-W70A

**MITSUBISHI :**

A866X17072      A866X21072

**Unit no.**

FORD

F2JY-10346A

MAZDA

JE15-18-300A      JE27-18-300      JE28-18-300      JF07-18-300

MITSUBISHI

A2T13977      A2T18177      A2T18277      A2T18874      A2T19677      A2T19877

A2T32899      A5T00777

MITSUBISHI MOTORS

MD150657

## VR-H2009-34

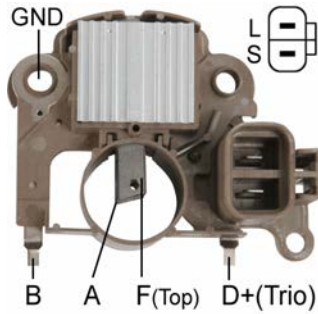

\*S-L Terminals  
 \*Repair Circuit:VR-H2009-10AS  
 \*Voltage Set Point:14.5V

### Replaces

**MITSUBISHI :**  
 A866X15770

### Unit no.

MITSUBISHI  
 A1T03391            A1T03791  
 SUBARU  
 23700-KA240        23700-KA360

## VR-H2009-35

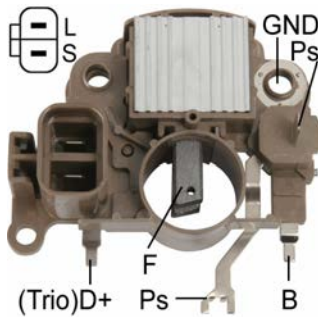

\*S-L Terminals  
 \*Repair Circuit:VR-H2009-10S  
 \*Voltage Set Point:14.5V

### Replaces

**MITSUBISHI :**  
 A866X18972

### Unit no.

MAZDA  
 F2G8-18-300  
 MITSUBISHI  
 A5T02377

## VR-H2009-37

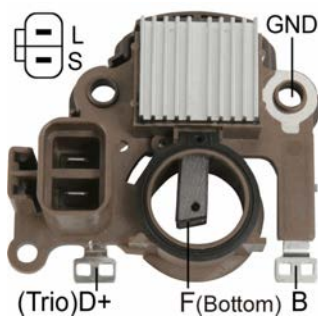

\*S-L Terminals  
 \*S Open Lamp ON  
 \*Repair Circuit:VR-H2009-43S  
 \*Voltage Set Point:14.5V

### Replaces

**MITSUBISHI :**  
 A866X23172

### Unit no.

MITSUBISHI  
 A2T38391            A4T02591            AT506591

**VR-H2009-38**

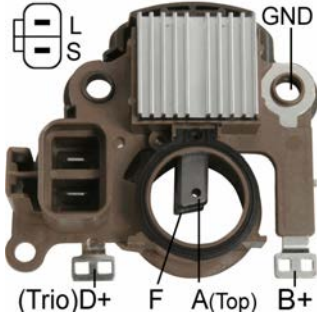

\*S-L Terminals  
 \*S Open Lamp OFF  
 \*Repair Circuit:VR-H2009-38S  
 \*Voltage Set Point:14.6V

**Replaces**

**MITSUBISHI :**  
 A860X25472      A866X22272      A866X39772  
**MITSUBISHI MOTORS :**  
 MD618569

**Unit no.**

FORD  
 F3XA-10300AC  
 MITSUBISHI  
 A2T34892      A2T34991      A2T34992      A2T35091      A2T35092      A2T36391  
 A2T36392      A2T38291      A2T38391      A2T38491      A2T38891      A2T38892  
 A2T39992      A3T11591      A3T12991      A3T13091      A3T13191      A3T13291  
 A3TA0791  
 MITSUBISHI MOTORS  
 MD175810      MD175811      MD177244      MD184278      MD184279      MD184280  
 MD184281      MD189658      MD189659      MD190812      MD190819      MD191402  
 MD191578      MD194466      MD196857      MD196858      MD198648      MD198649  
 NISSAN  
 23100-OB00

**VR-H2009-40**

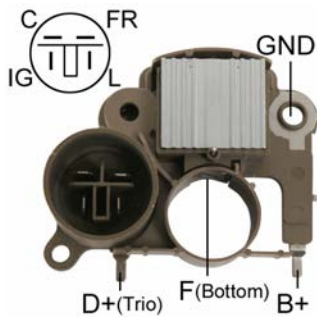

\*C-FR-IG-L  
 \*Repair Circuit: VR-H2009-40S  
 \*Voltage Set Point:14.6V

**Replaces**

**MITSUBISHI :**  
 A866X22081  
**Unit no.**  
 HONDA  
 31100-O08-014      04314-P08-014  
 MITSUBISHI  
 A5T04092

**VR-H2009-41**

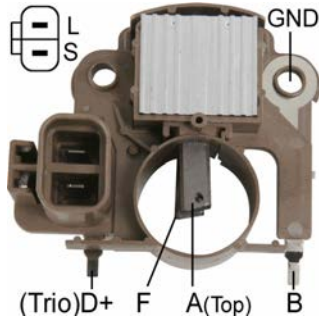

\*S-L Terminals  
 \*Repair Circuit:VR-H2009-11S  
 \*Voltage Set Point:14.6V

**Replaces**

**MITSUBISHI :**  
 A866X11772      A866X19072  
**MITSUBISHI MOTORS :**  
 MD611743

**Unit no.**

MITSUBISHI  
 A4T01493      A4T01793      A4T01893      A4T02991      A4T03091      A4T03191

**VR-H2009-43**

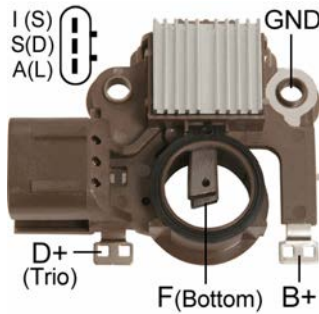

\*I-S(D)-A Terminals  
 \*Repair Circuit:VR-H2009-43S  
 \*Voltage Set Point:14.5V

**Replaces**

**MITSUBISHI :**  
 A866X24272  
**Unit no.**  
 FORD  
 F3DZ-10346A      F3LU-10300BC  
 MITSUBISHI  
 A6T41491      A6T41591

**VR-H2009-44**

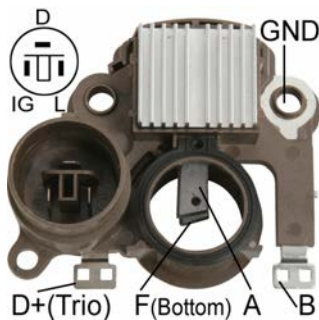

\*D-IG-L Terminals  
 \*Repair Circuit:VR-H2009-44S  
 \*Voltage Set Point:14.7V

**Replaces**

**MITSUBISHI :**  
 A866X23772  
**Unit no.**  
 MITSUBISHI  
 A5T07091ZC      A5T07092ZC  
 SUZUKI  
 31400-50G10      31400-60ACI      31400-63BD2

**VR-H2009-45**

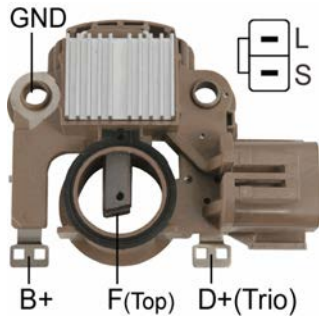

- \*S-L Terminals
- \*Repair Circuit:VR-H2009-45S
- \*Lamp Short Circuit Protection
- \*Voltage Set Point:14.5V

**Replaces**

**MITSUBISHI :**  
 A866X22472      A866X23072  
**NISSAN :**  
 23215-64J13

**Unit no.**

MITSUBISHI  
 A2T33593      A7T02874  
 NISSAN  
 23100-OP515

**VR-H2009-46**

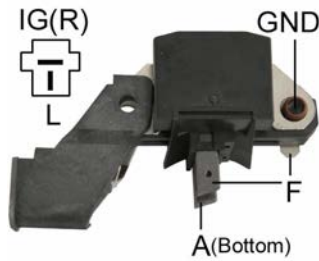

- \*R-L Terminals
- \*Voltage Set Point:14.7V

**Replaces**

**MITSUBISHI :**  
 A866T08570  
**MITSUBISHI MOTORS :**  
 ME700556

**Unit no.**

MITSUBISHI  
 A2T32583  
 MITSUBISHI MOTORS  
 ME017588

**VR-H2009-47**

\*24V  
 \*R-L Terminals  
 \*Voltage Set Point:28.3V

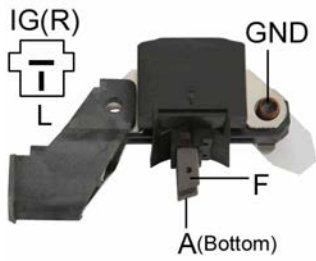

**Replaces**

**MITSUBISHI :**  
 A866T06870

**MITSUBISHI MOTORS :**  
 ME700635

**Unit no.**

MITSUBISHI

A2T32583

A2T72286

A4T57789

A4T57886

A4T65988

A6T75186

A6T75286

MITSUBISHI MOTORS

ME017563

ME017588

ME037640

ME037641

ME037644

ME037989

ME067529

**VR-H2009-48**

\*R-L Terminals  
 \*For Fuso Truck  
 \*Voltage Set Point:14.7V

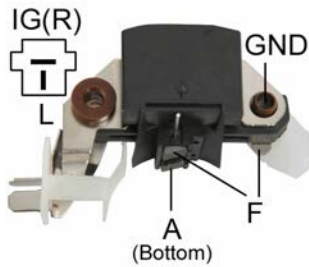

**Replaces**

**MITSUBISHI :**  
 A866T06570

**Unit no.**

MITSUBISHI

A5T22578

A5T22583

MITSUBISHI MOTORS

ME001570

ME007577

**VR-H2009-49**

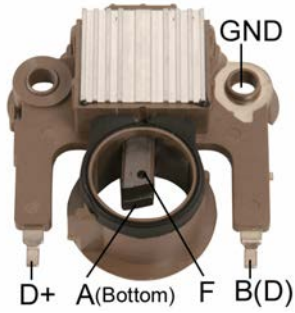

\*Repair Circuit:VR-H2009-49S  
 \*For 23mm OD slip ring  
 \*Voltage Set Point:14.6V

**Replaces**

**MITSUBISHI :**  
 A866X23200

**Unit no.**

MITSUBISHI

A2T13391C	A2T14591	A2T14592	A2T17491	A2T28792	A2T32692
A2T34591	A2T37091A	A2T37691	A2T81891	A2TA2292	A2TA2392
A2TA2492	A2TA2591	A4T00991	A4T00991C	A4T00991D	A4T03392
A4T03492					

**VR-H2009-4A**



\*Original part number is VR-MD02  
 \*For Use on Kia Pride 45A Alternator

**Replaces**

**MAZDA :**

E356-18-W70	E358-18-W70	FE65-24-520	FE79-24-520
-------------	-------------	-------------	-------------

**MITSUBISHI :**

A866T05272	A866X04870	A866X04871	A866X04872	A866X05470	A866X05471
A866X05472	A866X06072	A866X08672	A866X08672	A866X11682	

**MITSUBISHI MOTORS :**

MD611032	MD611146	MD618207	MM502532
----------	----------	----------	----------

**Unit no.**

KIA

02131-9021	OK72A-18300
------------	-------------

**Used On**

**KIA**

Pride	1.3L	1995-
-------	------	-------



**VR-H2009-4H**



\*R-L Terminals  
 \*Repair Circuit:VR-H2009-4S  
 \*Voltage Set Point:14.7V

**Replaces**

**FORD :**

E8GY-10316 E8JY-10316

**HYUNDAI :**

37370-21200

**MAGNETI MARELLI :**

940038085

**MAZDA :**

E356-18-W70 FE65-24-520 FE79-24-520

**MITSUBISHI :**

A866X04871 A866X04872 A866X05470 A866X05471 A866X05472 A866X06072

**MITSUBISHI MOTORS :**

MD611032 MD611146

**NISSAN :**

23215-P0410

**Unit no.**

**FORD**

E8GY-10346A E8GY-10346B E9BZ-10346A

**HYUNDAI**

37300-21013 37300-21320 37900-21030

**MANDO**

AR160A

**MAZDA**

B359-18-300 B655-18-300 B655-18-300A E356-18-300A F820-18-300 FE68-18-300

FE68-18-300B N249-18-300 N249-18-300B N304-18-300 N304-18-300B N318-18-300

N320-18-300 N326-18-300

**MITSUBISHI**

A1T01991 A1T40391 A1T40491 A1T40791 A1T40891 A2T00991

A2T03072 A2T03691 A2T03792 A2T03892 A2T04474 A2T07577

A2T13571 A2T13571A A2T17872 A2T41677 A2T41791 A2T41991

A2T42777 A2T43791 A2T43891 A2T43892 A2T44991 A2T47371

A2T47371A A2T47474 A2T47947 A2T49891 A5T30574 A5T30871

A5T40374 A5T41474

**MITSUBISHI MOTORS**

MD069978 MD073067 MD074644 MD074645 MD074992 MD082419

MD091793 MD091794 MD091849 MD091850 MD099624 MD099625

MD106508 MD108305 MD109741 MD111151 MD111607

**VR-H2009-50**

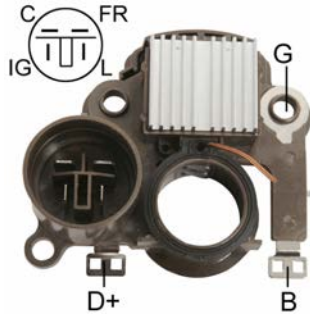

\*C-FR-IG-L Terminals  
 \*Repair Circuit:VR-H2009-50S  
 \*Voltage Set Point:14.5V

**Replaces**

**MITSUBISHI :**  
 A866X26641

**Unit no.**

HONDA  
 AHGA19  
 MITSUBISHI  
 A5T06491ZC

**VR-H2009-51**

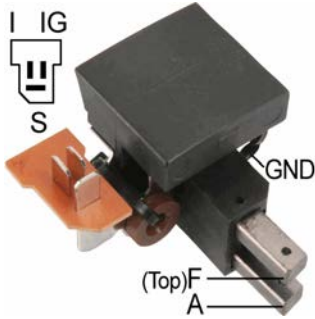

\*S-IG-L Terminals  
 \*Voltage Set Point:14.5V

**Replaces**

**MITSUBISHI :**  
 A866T01871      A866X01871  
**NISSAN :**  
 23215-W1710

**Unit no.**

MAZDA  
 4813-18-300  
 MITSUBISHI  
 A2T25377      A2T25378      A2T25578      A2T25584      A2T25598      A3T32977  
 A3T32989      A3T33678      A3T33684      A3T33698  
 NISSAN  
 23100-17S10      23100-17S15      23100-G3710      23100-G3711      23100-G3715      23100-G3716  
 23100-W1710      23100-W1714      23100-W1715      23100-W1719

**VR-H2009-53**

\*R-L Terminals  
\*Voltage Set Point:14.5V

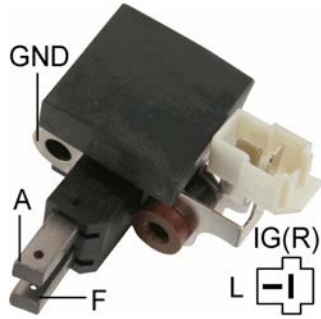

**Replaces**

**MAZDA :**  
8599-24-520  
**MITSUBISHI :**  
A866X02170

**Unit no.**

MAZDA				
8599-18-300	S201-18-300	S201-18-300A	S241-18-300	S241-18-300A
MITSUBISHI				
A1T23479	A1T32779	A2T25470		

**VR-H2009-54**

\*R-L Terminals  
\*Voltage Set Point:14.5V

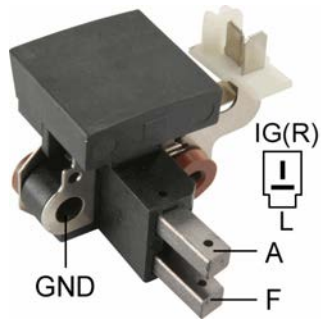

**Replaces**

**MITSUBISHI :**  
A866X01670  
**MITSUBISHI MOTORS :**  
MD607500

**Unit no.**

MITSUBISHI	
A2T24884	A3T21584
MITSUBISHI MOTORS	
MD050190	MD050194

**VR-H2009-56**

\*S-L Terminals  
\*Voltage Set Point:14.6V

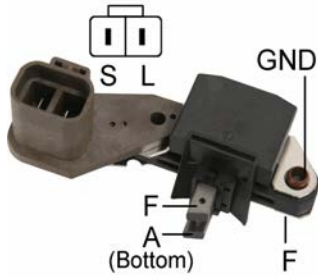

**Replaces**

**MITSUBISHI :**  
A866X05870  
**NISSAN :**  
23215-05E16

**Unit no.**

MITSUBISHI  
A3T35278            A3T35299  
NISSAN  
23100-05E18        23100-05E70

**VR-H2009-57**

\*R-L Terminals  
\*Voltage Set Point:14.7V

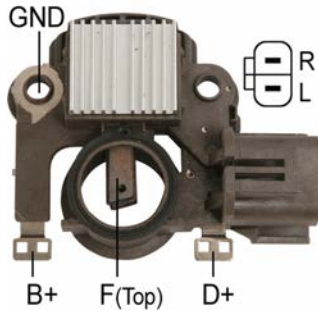

**Replaces**

**MITSUBISHI :**  
A866X25872

**Unit no.**

MITSUBISHI  
A7T02874

**VR-H2009-58**

\*Repair Circuit:VR-H2009-58S  
\*Voltage Set Point:14.6V

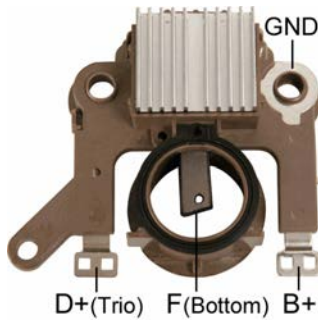

**Unit no.**

MITSUBISHI  
A2TA0591            A2TA0592            A2TA1981            A2TA1994            A2TA2091            A2TA2094  
A2TA2094B

**VR-H2009-59**

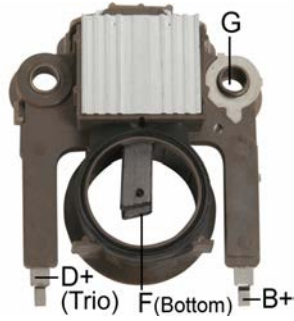

\*For 28mm OD slip ring  
\*Voltage Set Point:14.6V

**Replaces**

**MITSUBISHI :**  
263

**Unit no.**

MITSUBISHI  
A2T34598      A4T00891      A4T02891      A4T02892      A4T03292      A4TA0091D

**VR-H2009-62**

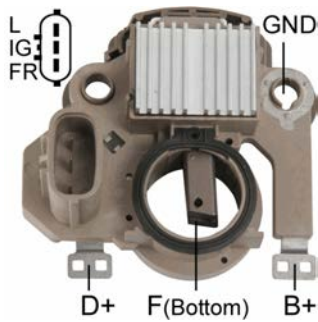

\*L-IG-FR Terminals  
\*Voltage Set Point:14.5V

**Replaces**

**MITSUBISHI :**  
A866X31882

**Unit no.**

MITSUBISHI  
A5TA1191ZC

**VR-H2009-63**

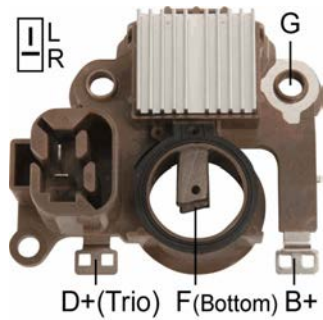

\*Inactive Lamp  
\*R-L Terminals  
\*Voltage Set Point:14.7V  
\*w/o capacitor

**Replaces**

**MITSUBISHI :**  
A866X26172

**MITSUBISHI MOTORS :**  
MD618845

**Unit no.**

MITSUBISHI  
A1T06391      A1T06672      A1T06791      A1T06891      A1TA0091      A1TA0291  
A1TA0491      A1TA0591      A1TA0691      A1TA0791      A1TA0991  
MITSUBISHI MOTORS  
MD300720      MD305885      MD305886      MD309331      MD311138      MD311711  
MD311712      MD317530      MD317531      MD319045      MD319317      MD319575

**VR-H2009-64**

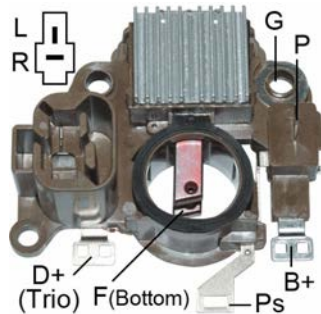

\*R-L Terminals  
\*Voltage Set Point:14.7V

**Replaces**

**MITSUBISHI :**  
A866X24572

**Unit no.**

MITSUBISHI  
A7T02077A      A7TA0477

**VR-H2009-64A**

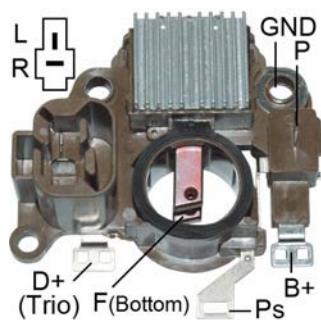

\*R-L Terminals  
\*w/ Choke  
\*Voltage Set Point:14.7V  
\*Regitar No.:VRH2009-64M

**Replaces**

**MITSUBISHI :**  
MM502585

**VR-H2009-65**

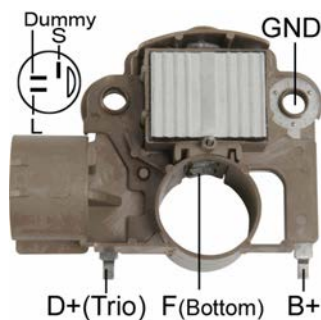

\*S-L Terminals  
\*Voltage Set Point:14.5V

**Replaces**

**MITSUBISHI :**  
A866X17272

**Unit no.**

MITSUBISHI  
A2T09591  
NISSAN  
23700-AA180

**VR-H2009-66TF**

\*VR-H2009-66 Test Fixture

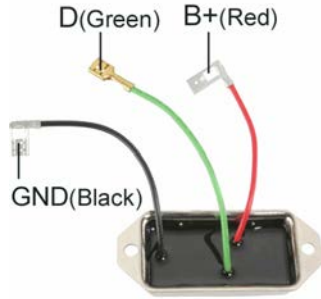

**VR-H2009-67**

\*S-L Terminals  
\*Voltage Set Point:14.5V

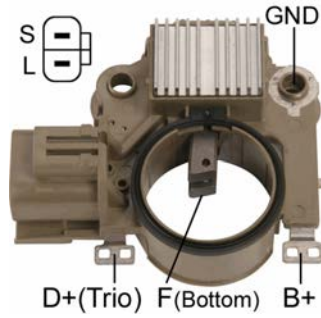

**Replaces**

**MAZDA :**

RGF1-18-W70

**MITSUBISHI :**

385                      255                      A866X24972                      A866X25572                      A866X24472                      A866X24972

A866X38472

**MITSUBISHI MOTORS :**

MD618735                      MD619167

**Unit no.**

**HYUNDAI**

37300-42354                      37300-42356

**MITSUBISHI**

A2T37976                      A2TN0076                      A2TN0199                      A2TN0299                      A2TN0399                      A2TN0499

A2TN0599                      A3T11678                      A3TN0078                      A3TN0199                      A3TN0299                      A3TN0399

A3TN0499                      A3TN0699                      A3TN15099

**Used On**

**HYUNDAI**

Starex

**MITSUBISHI**

L300

**VR-H2009-69**

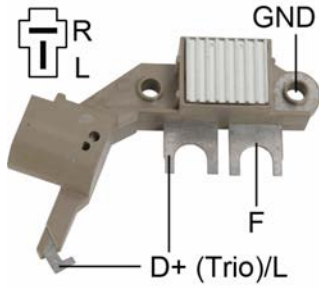

\*R-L Terminals  
\*Voltage Set Point:14.7V

**Replaces**

**MITSUBISHI :**  
A866X08971      A866X23972  
**MITSUBISHI MOTORS :**  
ME700799      ME701260

**Unit no.**

MITSUBISHI  
A004T25788  
MITSUBISHI MOTORS  
ME015164

**VR-H2009-69B**

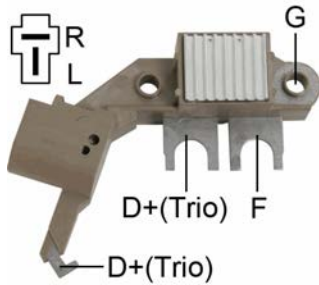

\*24V  
\*R-L Terminals  
\*Voltage Set Point:28.6V

**Replaces**

**MITSUBISHI :**  
A866X08871      A866X19972  
**MITSUBISHI MOTORS :**  
ME700783      ME701196

**Unit no.**

MITSUBISHI

A4T58289	A4T58686	A4T58689	A4T58699	A4T58786	A4T58799
A4T58986	A4T58989	A4T58999	A4T59086	A4T59199	A4T59786
A4T66486	A4T66786	A4T75586	A4T75589	A6T55186	A6T55189

MITSUBISHI MOTORS

ME057701	ME060076	ME077137	ME077138	ME077404	ME077574
ME087566	ME087567	ME087630	ME087643	ME090198	ME090592
ME091136	ME091535	ME093221	ME093222	ME093474	ME150001
ME150093	ME150142	ME150143	ME150650	ME150651	ME150963



**VR-H2009-6A**



- \*S-L Terminals
- \*Voltage Set Point: 14.6V
- \*For Use on Kia Pride 65A Alternator

**Unit no.**

KIA  
KK339-18300  
MANDO  
AB150021

**Used On**

KIA		
Pride	1.3L	2000-

**VR-H2009-6H**



\*S-L Terminals  
 \*Repair Circuit:VR-H2009-5S  
 \*Voltage Set Point:14.6V

**Replaces**

**LUCAS :**

21513125 UCJ235

**MAGNETI MARELLI :**

940038088

**MITSUBISHI :**

A866T05270	A866X05270	A866X05272	A866X09071	A866X09771	A866X09782
A866X12472					

**MITSUBISHI MOTORS :**

MD611432	MD611565	MD611588	MD611710	MD618483
----------	----------	----------	----------	----------

**NISSAN :**

23125-04P10	23215-04P10
-------------	-------------

**Unit no.**

**HYUNDAI**

37300-32520	37300-35020
-------------	-------------

**MITSUBISHI**

A2T02271	A2T02471	A2T03471	A2T03477	A2T03972	A2T04271
A2T04992	A2T06871	A2T09493	A2T09691	A2T09792	A2T14792
A2T17692	A2T40671	A2T48176	A2T48176A	A2T48176B	A2T48195
A2T48195A	A2T48195B	A2T48691	A2T48791	A2T49972	A2T49977
A2T49992	A3T00692	A3T00792	A3T02192	A3T02193	A3T03393
A3T03493	A3T04292	A3T04493	A3T41876	A3T41892	A3T45693
A3T45694	A5T41094				

**MITSUBISHI MOTORS**

MD061150	MD102084	MD102085	MD102088	MD105339	MD106713
MD108230	MD108509	MD109166	MD110318	MD111233	MD112322
MD114620	MD117156	MD122338	MD125569	MD126110	MD134315
MD136838	MD136839	MD140247	MD141855		

**NISSAN**

23100-02E10	23100-02E11	23100-02E15	23100-02E16	23100-05P11	23100-05P12
23100-14P11	23100-14P12	23100-15P11	23100-15P12	23100-15P13	23100-15P90
23100-15P91	23100-42L11	23100-42L71			

**VR-H2009-6HL**



\*S-L Terminals  
 \*Voltage Set Point:14.4V  
 \*\* For Iran Market Only

**Replaces**

**KIA :**

KK137-24-W70

**Unit no.**

**KIA**

M13NI-18-300B

**VR-H2009-70A**

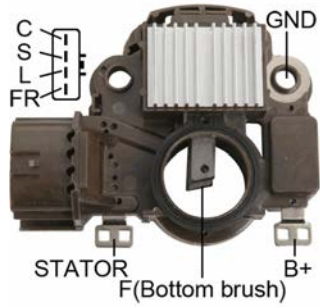

- \*C-S-L-FR Terminals
- \*Soft Start
- \*Repair Circuit:VR-H2009-70AS
- \*Voltage Set Point:14.4V

**Replaces**

**MITSUBISHI :**  
A866X34172 MD619268  
**MITSUBISHI MOTORS :**  
MD619268

**Unit no.**

MITSUBISHI					
A2TA4991	A2TA5191	A2TA5192	A2TA5391	A2TB0892	A3TA1691
A3TA2291A	A3TA4691	A3TA4791	A3TA5291	A3TA5491	

**VR-H2009-71**

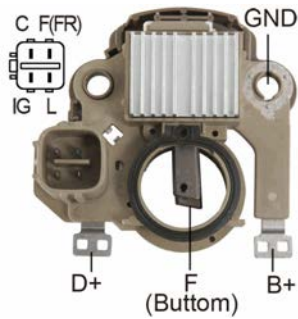

- \*C-F(FR)-IG-L Terminals
- \*Voltage Set Point:14.5V

**Replaces**

**MITSUBISHI :**  
3177203J 504  
**MITSUBISHI MOTORS :**  
ME10997D

**Unit no.**

HONDA  
31150-P2E-A01  
MITSUBISHI  
A5TA0991

**VR-H2009-73**

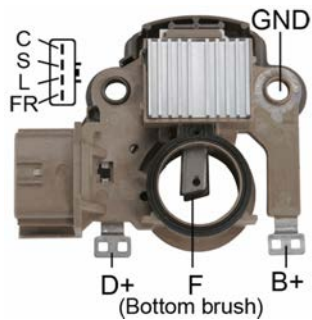

\*C-S-L-FR Terminals  
 \*Repair Circuit:VR-H2009-73S  
 \*Voltage Set Point:14.4V

**Replaces**

**MITSUBISHI :**

A866X28572      285

**MITSUBISHI MOTORS :**

MD618957

**Unit no.**

MITSUBISHI

A2T82791      A2TA0891ZC      A5TA0291

MITSUBISHI MOTORS

MD313392

**VR-H2009-75**

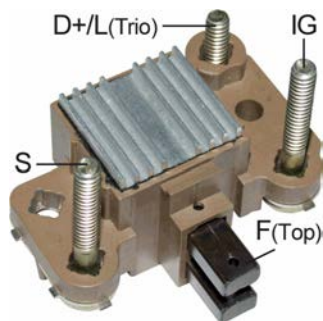

\*Excitation: Trio/A  
 \*Voltage Set Point:14.6V

**Replaces**

**MANDO :**

809163      811883      A500C0111

**MELROE :**

6659393

**VALEO :**

809163      811883      A500C0111

**Unit no.**

MANDO

A000B0331      A000B0431      AC155603      AC155604      AC155614      AC165617

AC155515      AC155643

MELROE

6661611

**VR-H2009-77B**

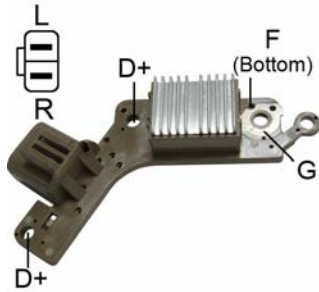

\*24V  
 \*L-R Terminals  
 \*Voltage Set Point:28.5V

**Replaces**

**MITSUBISHI :**  
 A866X26070      A866X26072  
**MITSUBISHI MOTORS :**  
 ME701302

**Unit no.**

MITSUBISHI					
A004T40286	A004T40289	A004T40386	A004T40389	A004T70086	A004T70099
A004T70189	A004T95099	A004TU3088	A004TU3186		
MITSUBISHI MOTORS					
ME017632	ME077788	ME077789	ME077790	ME077869	ME092899
ME093245	ME093246	ME160917	ME160918		

**VR-H2009-78**

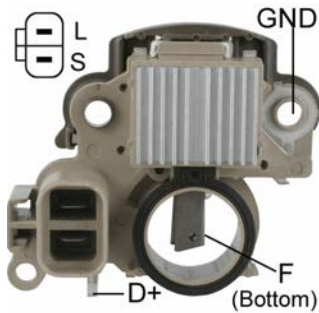

\*L-S Terminals  
 \*Inactive Lamp  
 \*S Open Lamp Off  
 \*Voltage Set Point: 14.5V

**Replaces**

**MITSUBISHI :**  
 A866T09780      A866T09782

**Unit no.**

HYUNDAI					
37300-32800	37300-33010	37300-33013	37300-33030	37300-33100	37300-33101
37300-33103					
MANDO					
AB175020	AB190025	AB190072	AB190119		
MITSUBISHI					
A3T03393					
MITSUBISHI MOTORS					
MD136838					

**VR-H2009-79**



\*S-L Terminals  
\*Voltage Set Point:14.5V

**Replaces**

**MITSUBISHI :**

A866X27572 275

**MITSUBISHI MOTORS :**

ME701363

**Unit no.**

MITSUBISHI

A2TA3098

A3T09198

A3T09199

A3T09698

A3T09699

A3T09799

A3TA3098

A3TA6098

**VR-H2009-7H**

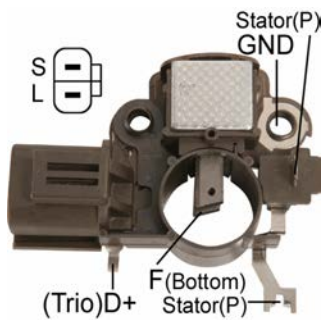

\*S-L Terminals  
\*Repair Circuit:VR-H2009-7S  
\*Voltage Set Point:14.6V

**Replaces**

**FORD :**

E8GY-10316B E8GZ-10316A

**MAGNETI MARELLI :**

940038084

**MAZDA :**

B675-18-W70 B675-18-70A

**MITSUBISHI :**

A866X12980

A866X29272

A866X12770

A866X12772

A866X12780

A866X12782

**Unit no.**

FORD

E8GY-10346C

E8GY-10346D

E92Z-10346A

E92Z-10346B

F2F8-18300B

MAZDA

B675-18-300A

B675-18-300B

F202-18-300

F881-18-300A

MITSUBISHI

A2T05772

A2T05892

A2T05893

A2T20091

**VR-H2009-80**



\*L-R Terminals  
\*Voltage Set Point:14.7V

**Replaces**

**MITSUBISHI :**

A866X34997      349

**Unit no.**

MITSUBISHI

A2T38776      A2T36776      A2TN2384ZJ

MITSUBISHI MOTORS

MD344310

**VR-H2009-80B**

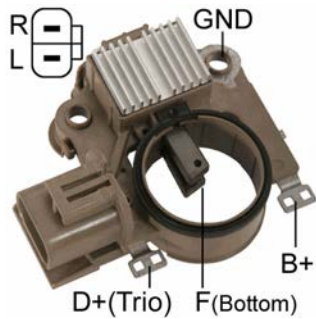

\*24V  
\*R-L Terminals  
\*Repair Circuit: VR-H2009-80BS  
\*Voltage Set Point:28.6V

**Replaces**

**MITSUBISHI :**

A866X28372      A866X41272      ME701399      283

**MITSUBISHI MOTORS :**

ME701399

**Unit no.**

MITSUBISHI

A3T75883      A3TN5188      A3TN5288

MITSUBISHI MOTORS

ME017615

**VR-H2009-82**

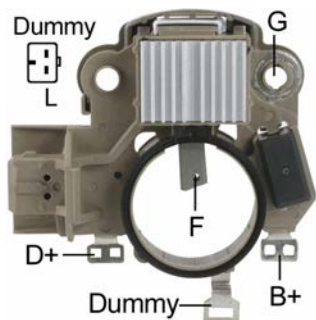

\*D-L Terminals  
\*Voltage Set Point:14.3V

**Replaces**

**MITSUBISHI :**

A866X40371      403

**Unit no.**

MITSUBISHI

A3TN1791

**VR-H2009-83**

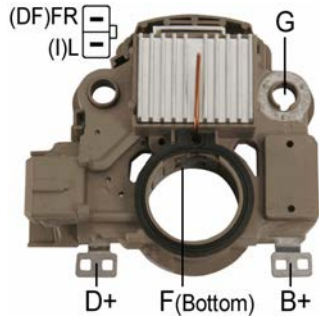

\*FR-L Terminals  
\*Voltage Set Point:14.5V

**Replaces**

**MITSUBISHI :**

A866X35872      358

**Unit no.**

MITSUBISHI

A5TA2591      A5TA4391      A5TA6591

**VR-H2009-85**

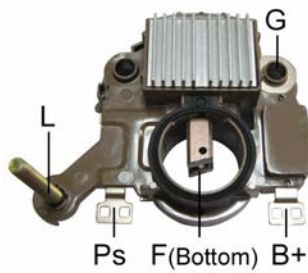

\*Active Lamp  
\*Short Circuit Protection  
\*Voltage Set Point:14.6V

**Replaces**

**MITSUBISHI :**

234309      362      499      458

**Unit no.**

MITSUBISHI

A2TB4891A

**VR-H2009-88**

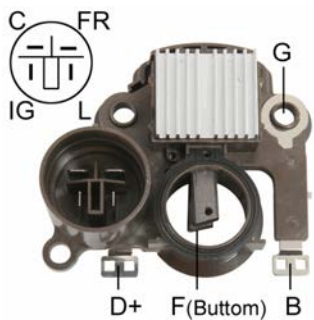

\*C-FR-IG-L Terminals  
\*Repair Circuit:VR-H2009-88S  
\*Voltage Set Point:14.5V

**Replaces**

**MITSUBISHI :**

A866T29570      A866X29582      VR295

**Unit no.**

HONDA

31100-P0G-A03      04314-P0G-A02

MITSUBISHI

A2TA2191



**VR-H2009-8H**

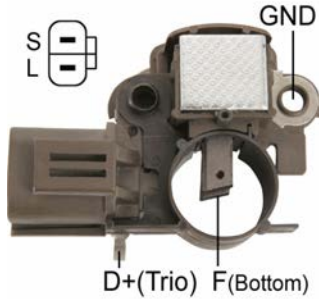

\*S-L Terminals  
 \*Repair Circuit:VR-H2009-7S  
 \*Voltage Set Point:14.6V

**Replaces**

**LUCAS :**

21513126 UCJ233

**MITSUBISHI :**

A866X08070 A866X08071 A866X08072

**NISSAN :**

23215-17B10 23215-51S10

**Unit no.**

**MITSUBISHI**

A2T02394 A2T02394B A2T46395 A2T46395B A2T47794 A2T47794B

A2T48292 A2T48298 A2T48472

**NISSAN**

23100-12C10 23100-12C11 23100-26E10 23100-26E11 23100-51S10 23100-D4410

23100-D4415 23160-07F11 23300-D4110

**VR-H2009-90**

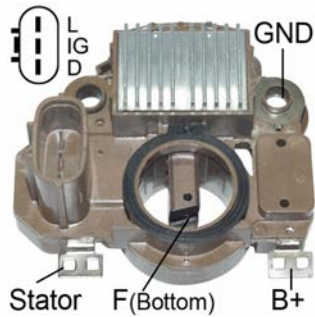

\*Inactive Lamp  
 \*L-IG-D Terminals  
 \*Short Circuit Protection  
 \*Voltage Set Point:14.6V

**Replaces**

**GM :**

91174657

**Unit no.**

**GM**

30020754

**MITSUBISHI**

A5TA4291 A5TA4291ZC

**SUZUKI**

31400-65D00 31400-65D01

**VR-H2009-92**



\*C-IG-L Terminals  
 \*Voltage Setting:14.5V

**Replaces**

**MITSUBISHI :**

A866X13571



**VR-H2009-95**

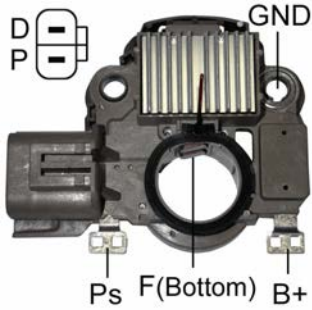

\* Inactive Lamp  
 \* D-P Terminals  
 \* Repair Circuit: VR-H2009-95S  
 \*\*\* Traditional test method will immediately damage P-D regulator. Avoid damage using Mobiletron VR-H2009-66TF test fixture.

**Replaces**

**MITSUBISHI :**

A866X35472	A866X34572	475	505	561
------------	------------	-----	-----	-----

**Unit no.**

MITSUBISHI

A2TB0091	A2TB2391	A2TB5491
----------	----------	----------

**VR-H2009-96B**

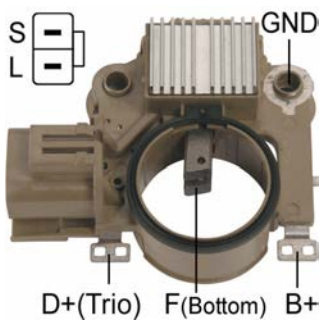

\*24V  
 \*S-L Terminals  
 \*Voltage Set Point:28.4V  
 \*L Terminal Does Not Drive Choke

**Replaces**

**MITSUBISHI :**

A866X38672
------------

**Unit no.**

MAZDA

A2T74684	A2T74776	A2T74876	A2T74976	A2T75076	A2T75176
A2T75282	A2T75376	A2T75476	A2T75576	A2TN5084	A2TN5384
A3TN5684	A3TN6579	A3TN6679			

**Used On**

**MAZDA**

Titan DE	HA24,SL24
Titan DE	TF24 VS24
Titan DE	TF24
Titan DE	TF24,TM24
Titan DE	SL24
Titan DE	HA24
Titan LPG	TF24

**VR-H2009-97**

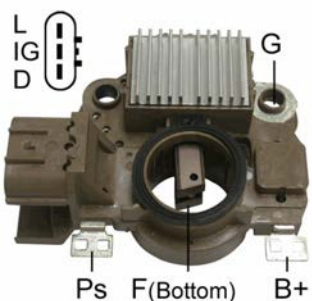

\*L-IG-D Terminals  
 \*6 sec. LRC  
 \*L Terminal Does Not Drive Choke  
 \*Voltage Set Point: 14.5V

**Replaces**

**MITSUBISHI :**

A866X45072
------------



**VR-H2009-9H**



\*R-L Terminals  
 \*Repair Circuit:VR-H2009-4S  
 \*Voltage Set Point:14.6V

**Replaces**

**FORD :**

E7GZ-10316A      F0BZ-10316A

**LUCAS :**

21513133

**MAGNETI MARELLI :**

940038086

**MAZDA :**

BF1462              FE85-18-W70

**MITSUBISHI :**

A866X07570      A866X07572

**MOTORCRAFT :**

GRE800

**Unit no.**

**FORD**

E7GZ-10346A      E8BZ-10346A      E8BZ-10346B      FOBZ-10346A      FOCZ-10346B

**MAZDA**

B101-18-300      B10-18-300A      B603-18-300      B603-18-300A      F651-18-300B      FE85-18-300

**MITSUBISHI**

A5T16471      A5T30977      A5T31177      A5T31971      A5T31971A

## VR-H2003-1B

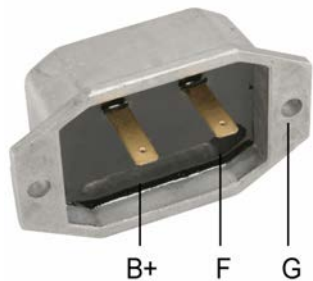

\*24V  
 \*B+ - F Terminals  
 \*Voltage Set Point:28.5V

### Replaces

#### ISUZU :

1-81251-004-0    1-81251-024-0    5-81251-012-0

#### NIKKO :

1-44000-0580    1-44000-0730

### Unit no.

#### ISUZU

1-81200-206-0	1-81200-209-0	1-81200-234-0	1-81200-265-0	1-81200-314-0	1-81200-459-0
1-81200-536-0	1-81200-541-0	1-81200-541-1	1-81200-544-1	1-81200-545-0	1-81200-545-1
1-81200-549-0	1-81200-551-0	1-81200-554-0	1-81200-558-0	1-81200-585-0	1-81200-844-0
5-81200-212-0					

#### NIKKO

0-33000-0050	0-33000-0060	0-33000-0071	0-33000-0120	0-33000-2200	0-33000-2280
0-33000-2290	0-33000-2800	0-33000-2841	0-33000-2870	0-33000-2871	0-33000-2880
0-33000-3070	0-33000-3071	0-33000-3130	0-33000-3700	0-33000-3710	0-33000-3760
0-33000-3810	0-33000-3970	0-33000-4400	0-33000-4402	0-33000-4670	0-33000-4750
0-33000-5100	0-33000-5280				

## VR-H2003-2B



\*24V  
 \*Voltage Set Point:28.8V

### Replaces

#### NIKKO :

1-44000-0900	0-33719-0030	0-33719-0031	7-44000-0901	0-33719-0100	0-33719-0120
1-44000-0900	7-44000-0900	7-44000-0903	7-44000-0905	7-44000-0906	7-44000-0920

**VR-LC401**



- \*24V
- \*W/surge protection
- \*Voltage Set Point:28.3V

**Replaces**

**PRESTOLITE :**

1861A726      594A-11      594A-14

**Unit no.**

PRESTOLITE

AC203RA

**VR-H2002-1**

\*24V  
 \*R-L-F-E-LA-N Terminals  
 \*Voltage Set Point:28.3V

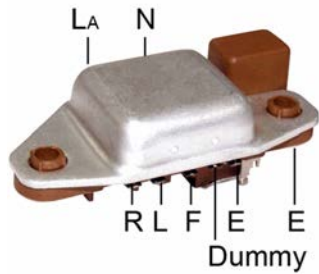

**Replaces**

**HINO :**  
 27700-1700  
**NISSAN :**  
 23500-Z9007  
**SAWAFUJI :**  
 1291-008-00X0  
**TOYOTA :**  
 27700-1700

**Unit no.**

NISSAN					
23099-96510	23099-Z5615	23099-Z5665	23100-97507	23100-Z5617	
SAWAFUJI					
0201-102-2921	0201-102-2963	0201-102-3110	0201-102-3112	0201-152-0010	0201-152-0021
0201-152-0043	0201-152-0053	0201-172-0013	0201-172-0112	0201-172-0121	0201-202-0011
0201-202-0210	0201-222-0013	0201-222-0023	0201-222-0113	0201-222-0220	0201-222-0262
0201-222-0272	0201-222-0312	0201-222-0412	0201-222-0421	0202-102-1811	0202-102-1823
0202-102-1910	0202-102-1921	0202-102-1933	0202-102-1943	0202-152-0010	0202-152-0021
0202-152-0033	0202-152-0043	0202-152-0123	0202-202-0011	0202-222-0012	0202-222-0023
0202-222-0110	0202-222-0142	0202-222-0152	0202-222-0211	0202-222-0222	
TOYOTA					
27040-1811					

**VR-H2002-2**

\*24V  
 \*L-F-C-E Terminals  
 \*Voltage Set Point:28.7V

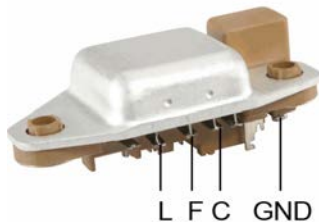

**Replaces**

**NISSAN :**  
 23500-Z9003  
**SAWAFUJI :**  
 1291-007-00X0

**Unit no.**

NISSAN					
23099-96504	23099-965503	23099-Z5604	23099-Z5605	23100-95015	23100-Z5602
SAWAFUJI					
0201-102-1020	0201-102-1210	0201-102-1220	0201-102-1310	0201-102-1410	0201-102-1710
0201-102-2020	0201-102-2610	0202-102-1010	0202-102-1011	0202-102-1020	0202-102-1110
0202-102-1111	0202-102-1120	0202-102-1121	0202-102-1211	0202-102-1310	0202-102-1411
0202-102-1510	0210-102-2020	0214-202-0310	0214-202-0319	0220-102-1211	0220-102-1310
0220-102-1411	0220-102-1510				
TOYOTA					
27040-1400	27040-1410	27040-1440	27040-1460	27050-1240	27050-1250
27050-1260	27050-1270				



**VR-H2002-3**

- \*24V
- \*R-L-F-C-E Terminals
- \*Voltage Set Point:28.7V



**Replaces**

**SAWAFUJI :**  
1291-006-00X0

**VR-V002**

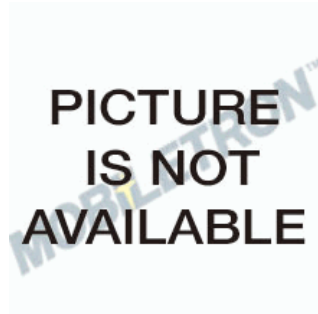

\*Voltage Set Point: 14.0V  
 \*\*\* Traditional test method will immediately damage P-D regulator. Avoid damage using Mobiletron VR-H2009-66TF test fixture

**VR-V0030**

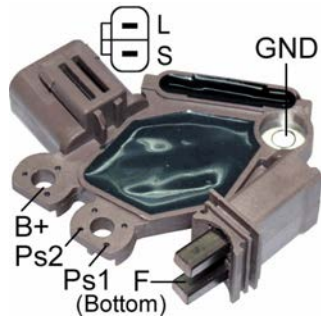

\*Soft Start  
 \*8.5 sec. LRC  
 \*Short Circuit Protection  
 \*Voltage Set Point: 14.6V

**Replaces**

VALEO :  
 2650030

**Unit no.**

NISSAN  
 23100-5Z000      23100-7Y020  
 VALEO  
 2650031      2650047

**Used On**

**NISSAN**

Quest 3.5L

2004-2009

**VR-V005**



\*Voltage Set Point: 14.5V

**Unit no.**

HYUNDAI  
 37300-23720

**Used On**

**HYUNDAI**

Accent

**KIA**

Cerato 1.6  
 Cerato 1.8L

**VR-V010**



\*B-Circuit  
 \*LIN-1  
 \*Requires COM01 test adaptor for testing

Unit no. [Redacted]  
 FORD  
 7G9T-10300BE

**VR-V014**

\*Voltage Set Point: 14.4V

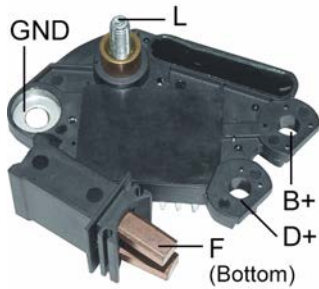

**Replaces** [Redacted]  
**MOTOROLA :**  
 9RC6131C

Unit no. [Redacted]  
 PEUGEOT  
 9611366880  
 STAM SANAT  
 9007561825  
 VALEO  
 SG9B091

**Used On** [Redacted]  
**PEUGEOT**  
 405  
 Pars

**VR-V015**

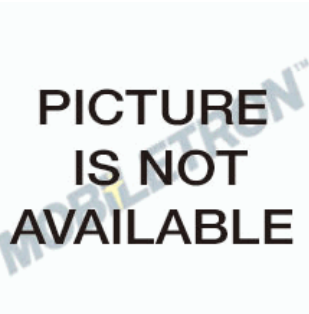

- \*Soft Start
- \*4.0 sec LRC
- \*Short Circuit Protection
- \*Voltage Set Point :14.5V

**Unit no.**

HYUNDAI  
37300-3G250  
VALEO  
TG12C057

**Used On**

HYUNDAI  
Sonata V6 3.3L 2010-

**VR-V021**

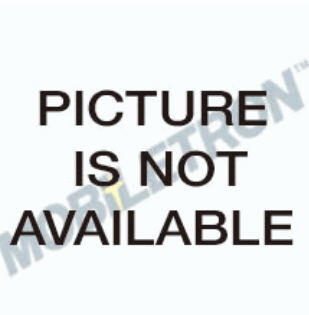

**Unit no.**

HYUNDAI  
37300-2E200  
VALEO  
2610428

**VR-V0219**



- \*Soft Start
- \*2.5 sec. LRC
- \*Short Circuit Protection
- \*Voltage Set Point: 14.6V

**Replaces**

VALEO :  
2650219            2650348            2650473

**Unit no.**

VALEO					
TG12C027	TG12C040	TG12C042	TG12C043	TG12C048	TG12C084
TG13S018	TG13S021	TG13S023	TG13S028	2606925	2650043
2650323B	2650323O	2650398	2650408	2650709	

**VR-V0441**

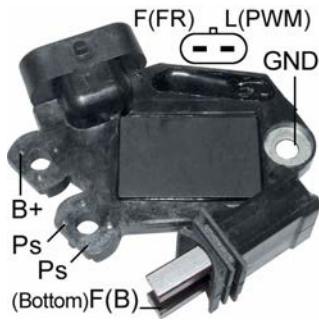

- \*Voltage Set Point: 13.8V
- \*Soft Start
- \*2.5 sec. LRC
- \*Short Circuit Protection
- \*Regulated Voltage Control(RVC)
- \*Requires RVC01 tester box for testing
- \*Regitar No.:VRVA0557

**Replaces**

**VALEO :**

2650441	2650561	15926088	2650557
---------	---------	----------	---------

**Unit no.**

**GM**

15201678	15215546	15251755	15784559	15863714
----------	----------	----------	----------	----------

**VALEO**

TG10S012	TG10S016	TG10S017	TG10S022	2650181	2650304
2650352	2650505	TG12S028	TG12S047	TG12S089	TG13S012
TG13S017	TG13S020	TG13S029			

**VR-V0447**

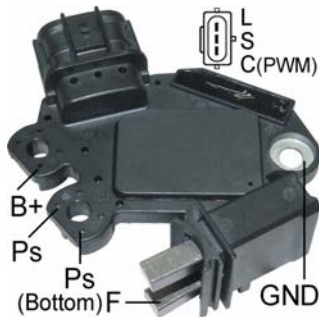

- \*C-S-L Terminals
- \*Soft Start
- \*Short Circuit Protection
- \*Voltage Set Point:14.5V
- \*Regulated Voltage Control(RVC)
- \*Requires RVC01 tester box for testing

**Replaces**

**VALEO :**

2650447	2606243A
---------	----------

**Unit no.**

**NISSAN**

23100-JA02A	23100-JA02B	23100-ZH00A	23100-ZH00B	23100-22DZ0A
-------------	-------------	-------------	-------------	--------------

**SUZUKI**

31400-82Z10

**VALEO**

2650538	TG15C113	TG15S147	TG12C032	2650364A	2650364B
TG12C103					

**Used On**

**INFINITI**

QX56 5.6L	2008-2010
-----------	-----------

**NISSAN**

Armada 5.6L	2007-2011
Frontier 4.0L	2008-2010
Pathfinder 4.0L	2008-2010
Pathfinder 5.6L	2008-2010
Titan 5.6L	2008-2010
Xterra 4.0L	2007-2010
Altima 4Cyl. 2.5L	2007-2009
Sentra 4Cyl. 2.5L	2007-2009

**SUZUKI**

Equator 4.0L	2009-2010
--------------	-----------

**VR-V1610**

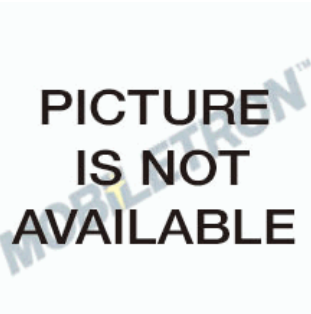

**Replaces**

**VALEO :**

593362	YM1610F	2541939B	2542349	2542482
--------	---------	----------	---------	---------

**Unit no.**

**VALEO**

2541997	2541998	2542294	A11VI95	A13VI223	A13VI241
---------	---------	---------	---------	----------	----------

**VR-V1658**

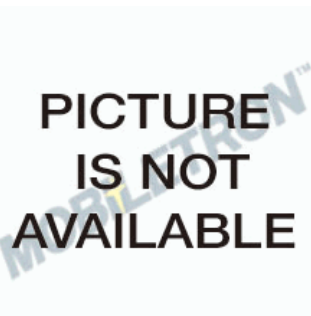

**Replaces**

**VALEO :**

593434	593466	YM1658
--------	--------	--------

**Unit no.**

**VALEO**

2542298A	SG12S019
----------	----------

**VR-V2263**

\*Requires COM01 test adaptor for testing



**Replaces**

**VALEO :**

593536	2612263
--------	---------

**Unit no.**

**BMW**

12317516098	12317516721	12317516722
-------------	-------------	-------------

**VALEO**

SG9B050	437374	439418
---------	--------	--------

**Used On**

**BMW**

3 Series

2000-2005

**VR-V2499**



- \*Soft Start
- \*2.5 sec. LRC
- \*Short Circuit Protection
- \*Voltage Set Point:14.6V

**Replaces**

VALEO :  
2542499

**Unit no.**

GM				
10317648	10327514	10350160		
VALEO				
2650010	2650011B	2650017A	SG10S029	SG10S035

**VR-V2599**

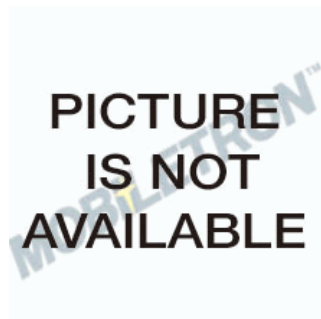

**Replaces**

VALEO :  
2542599            593532

**Unit no.**

VALEO	
2542564	2542564A

**VR-V2604**



\*BSS Connections  
\*Requires COM01 test adaptor for testing

**Replaces**

**VALEO :**

595365	2543535	591894	2543505	2591579	2591894
593263					

**Unit no.**

**BMW**

12317802261	12317802619	12317573754	12317573755	12317533469	12317561002
12317801124	12317804266				

**VALEO**

439602	439606	2543436	2543218	2543223	TG23C011
TG23C012	TG23C013	TG23018	FG18S019	439613	440183
543461A					

**Used On**

**BMW**

Truck X5 6Cyl. 3.0L	2009-2010
X5 6Cyl. 3.0L Diesel	2009-2010
X5 8Cyl. 4.8L	2007-2010
X6 6Cyl. 3.0L	2008-2010

**VR-V2775**

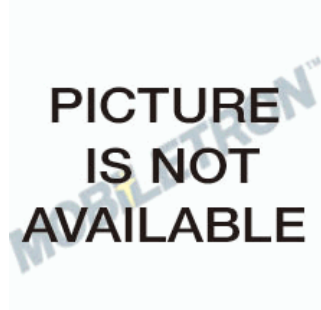

**Replaces**

**VALEO :**

2611164	593857	2542775
---------	--------	---------

**Unit no.**

**FIAT**

9646066880	9649611280
------------	------------

**TOYOTA**

27060-YV020

**VALEO**

2524924A	2542298A	2542693	2542726	2542832	2542832A
2543526A	2605546	2605546A	437471	437407	439502
439674	A14VI48	A14VI49	SG15S024	SG15S025	TG15C020
TG15C028	TG15C053	TG15C118	TG15C134		



**VR-V2871**

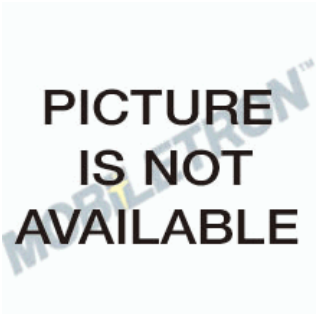

**Replaces**

VALEO :  
2605904

**Unit no.**

VALEO  
TG9S036

**VR-V2975**

BSS(COM) DUMMY



\*BSS connections  
\*Requires COM01 test adaptor for testing

**Replaces**

VALEO :  
2542957          2580429          2580499          2591800          2608222

**Unit no.**

VALEO  
TG17C020      TG17C022      TG17C023      TG17C024      TG17C039      TG17C040  
TG17C044      TG17C054      TG17C056      TG16C014  
VOLKSWAGEN  
06E903016D

**VR-V3231**



\*BSS Connections  
\*Requires COM01 test adaptor for testing

**Replaces**

<b>VALEO :</b>			
2543231	593984	593877	593983

**Unit no.**

BMW					
12317521178	12317525376	12317550968	12317551256	12317555926	
VALEO					
439560	TG17C015	2542720	TG17C016	TG17C016B	TG17C021
TG17C021B	TG17C027	TG17C027B	TG17C035	2543221	437579

**Used On**

**BMW**

330i 3.0	2005-2007
523i 2.5L	2005-2007
530i 3.0L	2007-
630i 3.0L	2004-2007
X3 2.5	2006-2007
X5 3.0	2007-2008
325i Coupe	2006-
325i Touring	2005-2007
330i Coupe	2006-
530xi 3.0L	2007-
530xi 3.0L	2007-
525i Touring	2007-

**VR-V3279**



\* Voltage Set Point: 14.3V  
\* LIN-1  
\* 19200 Baud Rate (4 Byte)  
\* Requires COM01 test adaptor for testing

**Replaces**

<b>VALEO :</b>					
595243	593958	2543279	2542964	2580469	2591559

**Unit no.**

VALEO					
TG17C028	TG17C030	TG17C030B	TG17C032	04801250AB	2542989B

**VR-V3406SE**

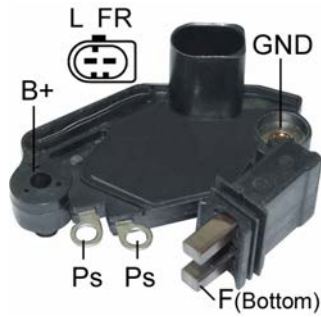

- \*Soft Start
- \*2.5 sec. LRC
- \*Short Circuit Protection
- \*Self Exciting
- \*Voltage Set Point: 14.4V

**Replaces**

**VALEO :**  
593406                      YR3634VFP2

**Unit no.**

VALEO  
A14VI34                      A14VI45                      A14VI46                      A14VI47

**VR-V3419**



- \*Soft Start
- \*2.5 sec. LRC
- \*Short Circuit Protection
- \*Voltage Set Point: 14.6V

**Replaces**

**VALEO :**  
593419                      2542549B

**Unit no.**

VALEO  
A11VI106                      A11VI108                      A13VI276                      A13VI277                      A13VI278                      A13VI279  
A13VI283                      A13VI288

**VR-V3419SE**



- \*Self Exciting
- \*Soft Start
- \*2.5 sec. LRC
- \*Short Circuit Protection
- \*Voltage Set Point: 14.6V

**Replaces**

**VALEO :**  
593419                      2542549B

**Unit no.**

VALEO  
A11VI106                      A11VI108                      A13VI276                      A13VI277                      A13VI278                      A13VI279  
A13VI283                      A13VI288

**VR-V3530**



- \*Voltage Set Point: 14.3V
- \*Soft Start
- \*Short Circuit Protection
- \*Regulated Voltage Control(RVC)
- \*Requires RVC01 tester box for testing

**Unit no.**

HYUNDAI					
37300-2E400					
VALEO					
2607372	2608483	2612741			

**Used On**

**HYUNDAI**

i20	2011-2012
Accent L4 1.6L	2012-2014
Veloster L4 1.6L	2012-

**KIA**

Rio L4 1.6L	2012-2013	
Ceed 1.6i	G4FC	2009-2013
Venga 1.4i	G4FA	2009-2013

**VR-V3666**



- \*Soft Start
- \*8.5 sec. LRC
- \*Short Circuit Protection
- \*Voltage Set Point: 14.6V

**Replaces**

**VALEO :**

593666	YM1689PF	2549916B
--------	----------	----------

**Unit no.**

RENAULT					
7711134926	8200138269	8200290220			
VALEO					
2542588	2542637	2542751	2542819	2543343	2543344
2543595	2543596	SG15L020	SG15L027	SG15L034	

**VR-V3689**



- \*Soft Start
- \*8.5 sec. LRC
- \*Short Circuit Protection
- \*Voltage Set Point: 14.6V

**Replaces**

**VALEO :**

593689                      YR1615PF                      2603741                      2542711

**Unit no.**

**VALEO**

SG12B096	SG12B103	TG11C010	TG11C011	TG11C022	TG11C027
TG11C034	TG11C049	TG15C058	TG8S017	SG12B105	SG12B109
SG12B110	SG12B052	SG12B055	SG12B068	SG12B071	SG12B072
SG12B081	SG12B09	SG12B097	TG11C046	TG11C061	TG11C064
TG11C063	TG8S025	TG9B053	SG12B107	SG12B122	SG12B123
SG9B089	SG9B108	SG12B092			

**VR-V3779**

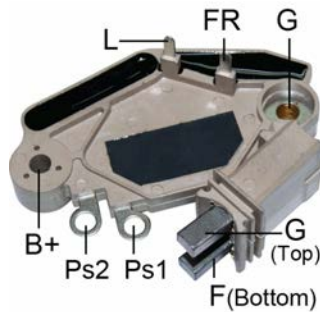

- \*Soft Start
- \*8.5 sec. LRC
- \*Short Circuit Protection
- \*Voltage Set Point: 14.6V

**Replaces**

**VALEO :**

593779                      YM1693VFP                      2542566

**Unit no.**

**VALEO**

SG15L012                      SG15L026

**Used On**

**CITROEN**

Berlingo 1.1i	MFHDZ	2002-2002
Berlingo 1.1i	MFHFX	2002-2002
Berlingo 1.6 16V	MFNFU	2000-2002
Saxo 1.0		1996-
Saxo 1.4 VTS		1999-
Saxo 1.6 VTL		

**MERCEDES-BENZ**

Vaneo 1.7L DSL		2002-2005
----------------	--	-----------



**VR-V3874**

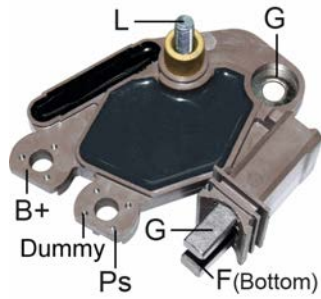

- \*Soft Start
- \*2.5 sec. LRC
- \*Short Circuit Protection
- \*Voltage Set Point: 14.6V

**Replaces**

VALEO :  
593874                      593454                      YM1666FP5

**Unit no.**

VALEO  
SG9B037                      SG9B038                      SG9B039

**VR-V3975**

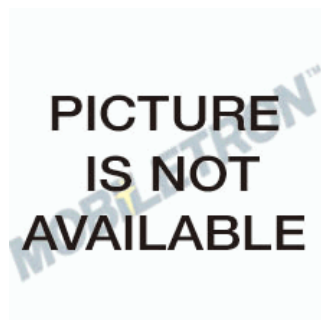

**Replaces**

VALEO :  
2604289                      593975                      595385

**Unit no.**

MERCEDES-BENZ  
2661540602                      2661540902                      A2661540602                      A2661540902  
VALEO  
TG11C074                      TG11C021                      TG11C035

**VR-V4114**

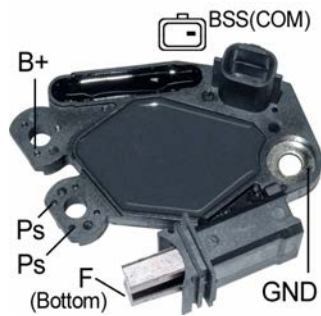

- \*BSS Connections
- \*Requires COM01 test adaptor for testing

**Replaces**

VALEO :  
2604114

**VR-V4291**

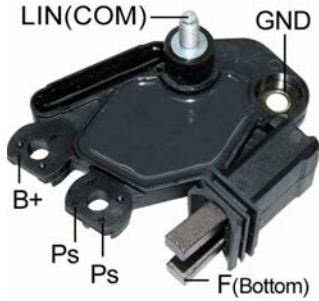

- \* Voltage Set Point: 14.3V
- \* LIN-1
- \* 9600 & 19200 Baud Rate (4 Byte)
- \* Requires COM01 test adaptor for testing

**Replaces**

**FORD :**  
 8V21-10300BB      9G9N-10300CA  
**MAZDA :**  
 Y406-18-300  
**VALEO :**  
 593970  
**VOLVO :**  
 3600909              31285808

**Unit no.**

FORD  
 8V21-10300AB  
 VALEO  
 2543427              TG15C121              TG15C103              TG15C057C              TG15C057B              TG15C057  
 TG12C038

**VR-V5001**

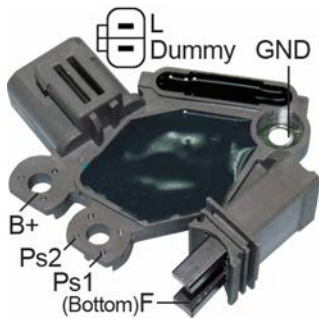

- \*Soft Start
- \*8.5 sec. LRC
- \*Short Circuit Protection
- \*Voltage Set Point: 14.6V

**Replaces**

**VALEO :**  
 2655001              20051012              2655479

**Unit no.**

HYUNDAI  
 37300-37400              37300-37405              37300-3A002  
 KIA  
 QK2AA-18-300              RK2AA-18-300U  
 VALEO  
 2655516              2655553              A0002655010              A0002655516              TG11C024



**VR-V5120**



**Replaces**

VALEO :

2605120                    2542919

Unit no.

VALEO

TG9B024

**VR-V5339**

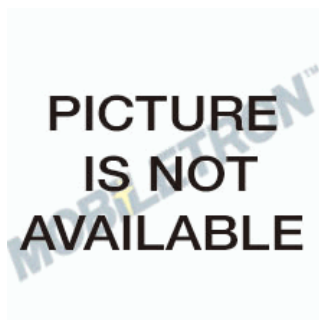

**Replaces**

VALEO :

595339

**VR-V5366**

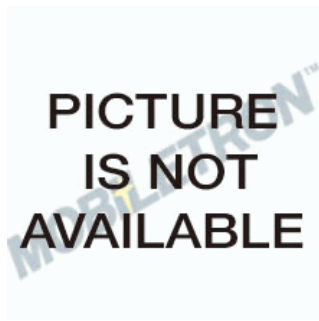

**Replaces**

VALEO :

595366

Unit no.

VALEO

TG9B068                    TG9B049                    2607214A

**VR-V5428**

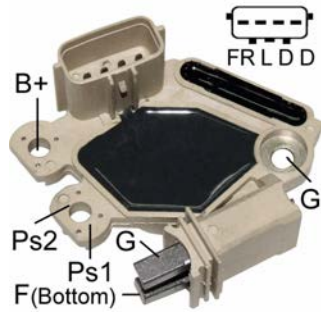

- \*Soft Start
- \*2.5 sec. LRC
- \*Short Circuit Protection
- \*Voltage Set Point: 14.6V

**Replaces**

VALEO :  
2655428

**Unit no.**

HYUNDAI  
37300-38400  
VALEO  
A0002655009

**Used On**

**HYUNDAI**

Santa 2.4 16V	2001-2006
Sonta 2.0 16V	2001-2004
Santa 2.7 V6 4X4	2001-2004
Sonta 2.7 V6	2001-2004

**KIA**

Magentis 2.0	2003-2006
--------------	-----------

**VR-V5460**



- \*Voltage Set Point: 13.8V
- \*Soft Start
- \*2.5 sec. LRC
- \*Short Circuit Protection
- \*Regulated Voltage Control(RVC)
- \*Requires RVC01 tester box for testing

**Replaces**

VALEO :  
2605460                      2616783

**Unit no.**

GM  
13500586  
VALEO  
TG12C070



**VR-V6131**

\*Voltage Set Point: 14.5V

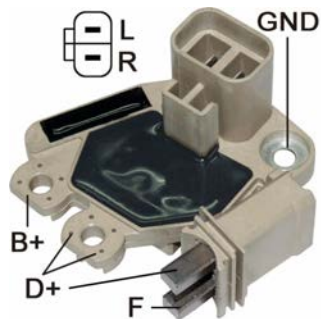

**Replaces**

VALEO :  
13480351

**Unit no.**

HYUNDAI  
37300-02550

**Used On**

**HYUNDAI**

Gets 1.1L	2002-2006
Amica 1.0L	2001-2003
Amica 1.1L	2004-2008

**KIA**

Picanto 1.0L	2004-2008
Picanto 1.1L	2004-2008

**VR-V7052**

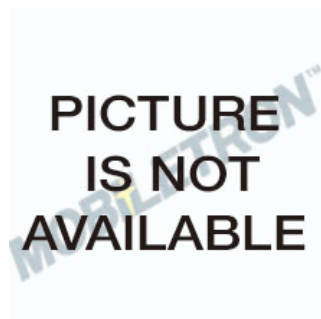

**Unit no.**

HYUNDAI  
37300-02600  
VALEO  
2607052

**Used On**

**HYUNDAI**

i10 1.1L	2011-
----------	-------

**KIA**

Picanto 1.0L	2009-
Picanto 1.1L	2004-

**VR-V7319**

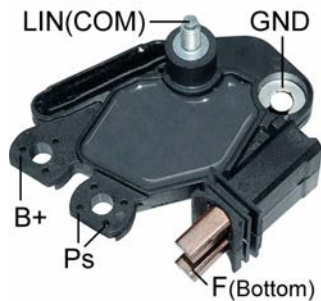

- \*B-Circuit
- \*Voltage Set Point: 13.8V
- \*LIN-1
- \*9600 & 19200 Baud Rate (4 Byte)
- \*Requires COM01 test adaptor for testing

Unit no.

FORD					
1685793	1704769	AV6N-10300GB	AV6NGB	AV6NGC	AV6N-10300GC
LUCAS					
LRA03470	LRA3470				
VALEO					
TG15C169	TG15C183				

**VR-V8237**

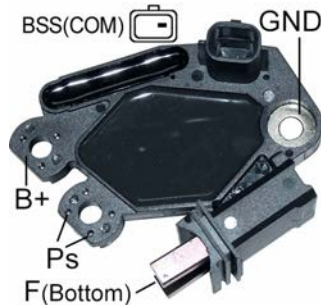

- \*BSS connections
- \*Requires COM01 test adaptor for testing

Replaces

VALEO :

595253	595252	595379
--------	--------	--------

Unit no.

VALEO					
TG11C041	TG11C055	TG11C060	TG11C066	TG11C069	TG15C091
TG15C125					

**VR-V8326**



- \*Soft Start
- \*Short Circuit Protection
- \*Voltage Set Point: 14.5V

**Replaces**

**VALEO :**  
2608326

**Unit no.**

KIA  
37300-2B101  
VALEO  
2655447

**Used On**

**KIA**

Soul 1.6L	2010-
Carens 1600	2009-2012
Pro Ceed 1400	2007-2012
Pro Ceed 1600	2007-2012

**VR-V9938**

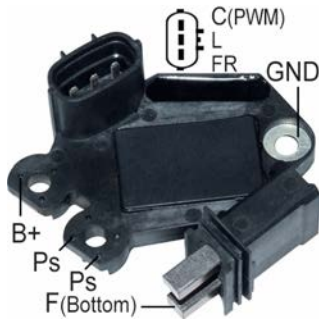

- \*Soft Start
- \*Short Circuit Protection
- \*Voltage Set Point: 14.3V
- \*Regulated Voltage Control(RVC)
- \*Requires RVC01 tester box for testing

**Replaces**

**VALEO :**  
2609938

**Unit no.**

HYUNDAI  
37300-2G150      37300-2G600

**Used On**

**HYUNDAI**

Sonata 2.0L	2010-2013
Sonata 2.4L	2010-2013
Santa Fe 2.4L	2010-2012

**KIA**

Optima 2.4L	2011-2013
Optima 2.0L	2012-
Sorento 2.4L	2011-2012

**VR-DU509**

\*Voltage Set Point:15.5V



**Replaces**

**BOSCH :**

0-190-601-014      9-190-110-539

**FEMSA :**

GRO12-10      GRO12-12      GRO12-7

**LUCAS :**

21930022      37696      NCB203      NCB212

**PEUGEOT :**

5761.28      5761.29      5761.31

**PORSCHE :**

91160390100

**SEV MARCHAL :**

33505      33523      71270402      72711202      72711502

**TALBOT :**

15224800      15224891      30201E      373994J      461138S

**VALEO :**

505046      77616      79905      NB973      NC334

**VALEO(DUCELLIER) :**

519004      8358      8367      8373      8380

**VALEO(MOTOROLA) :**

9RH7014

**VALEO(PARIS RHONE) :**

AYA2114      AYB214      AYB216      YL142

**VOLVO :**

6877982

**Unit no.**

**VALEO**

2074684	2077791	2093051	2093073	2095084	2095085
2095086	2095172	2095228	2095565	2095722	2097295
2097973	2102452	40170302	433396	436305	512002
512002A	512002B	512003	512003A	512003B	71211302
71220002	71220102	71220402	71220602	71220702	71220902
71221002	71223202	71223402	71223602	71223802	71226602
71227702	71270102	71270202	71270302	71270402	71271002
71273702	71427002	71923002	7250	7258C	7526
7526B	7526C	7528B	7531	7531B	7543
7543A	7543B	7545	7545A	7552	7552A
7552AB	7552B	7552C	7552D	7554	7554A
7560	7560A	7560B	7560C	7565	7565A
7565AB	7565B	7565C	7565D	7565DE	7565E
7566	7566A	7566AB	7566B	7566C	7567
7567A	7567AB	7567B	7567C	7567D	7567DE
7567E	7568	7568A	7568AB	7568B	7568C
7569A	7569ABC	7569B	7569C	7569D	7570
7570A	7570B	A12M1	A12M10	A12M18	A12M2
A12M3	A12M6	A12M7	A13M11	A13M13	A13M15
A13M16	A13M17	A13M2	A13M5	A13M7	A13M8
A13R127					

**VR-DU510**

\*Voltage Set Point:14.5V



**Replaces**

**BOSCH :**

9-190-110-031    9-190-110-034    9-190-110-041

**CITROEN :**

5491551            AK5351

**FEMSA :**

GRK12-13            GRK12-2            GRK12X-1            GRO12-2            GRO12X-1            GRO12X-9

**ISKRA :**

11-125-109            AER3006

**LUCAS :**

21930021            21931006            37175            37695            NCB201            NCB209

NCB211

**MAGNETI MARELLI :**

64800002

**PEUGEOT :**

5761.23            5761.24            5761.32            5761.33            5835.02

**RENAULT :**

7700519493            7700530749            7700544686            7700660469            7700666179            7701348281

**SEV MARCHAL :**

33036	33067	33081	33506	33518	33519
33522	33524	33525	33532	33538	33544
33545	33546	33548	33549	33560	33561
72260402	72260502	72260602	72415002	72415202	72415502
72415802	72416202	72416302	72610002	72610102	72610502
72610602	72610702	72610902	72710002	72710202	72710302
72710402	72710602	72710802	72711602	72717102	

**TALBOT :**

163009            42290B            55822700

**VALEO :**

100065	100207	505045	505048	505049	70335
70747	71854	74547	76722	76833	76834
77224	78819	79343	79368	79583	79584
79628	92361	92782	95394	96126	96637
96731	97343	97382	99464	NB175	NC333

NC886

**VALEO(DUCELLIER) :**

510002	510004	510005	519001	8320	8327
8328	8347	8349	8350	8357	8362
8364	8371	8372	8376	8378	8381

8382

**VALEO(MOTOROLA) :**

9RH7013            9RH7016            9RH7017

**VALEO(PARIS RHONE) :**

AY21	AY21T	AYA21	AYA210	AYA213	AYB21
AYB210	AYB211	AYB2110	AYB2113	AYB2115	AYB2116
AYB2118	AYB2119	AYB212	AYB2123	AYB2124	AYB2125
AYB2128	AYB213	AYB215	AYB218	YL411	

**VOLVO/DAF :**

01215477	01215565	114374	1259303	215565	292243
3292243					



**VR-DU510**

Unit no.

VALEO

2074684	2077791	2093051	2093073	2095084	2095085
2095086	2095172	2095228	2095565	2095722	2097295
2097973	2102452	433396	436305	512002	512002A
512002B	512003	512003A	512003B	71211302	71220002
71220102	71220402	71220602	71220702	71220902	71221002
71223202	71223402	71223602	71223802	71226602	71227702
71270102	71270202	71270302	71270402	71271002	71273702
71427002	71470302	71923002	7258	7526	7526B
7526C	7528B	7528C	7531	7531B	7543
7543A	7543B	7545	7545A	7552	7552A
7552AB	7552B	7552C	7552D	7554	7554A
7560	7560A	7560B	7560C	7565A	7565AB
7565B	7565C	7565D	7565DE	7565E	7566
7566A	7566AB	7566B	7566C	7567	7567A
7567AB	7567B	7567C	7567D	7567DE	7567E
7568	7568A	7568AB	7568B	7568C	7569A
7569ABC	7569B	7569C	7569D	7570	7570A

VALEO(DUCELLIER)

512001	513001	513002	513003	513004	513005
513008	513009	513010	513011	515002	515003
515005	515006	515007	515008	515009	515010
515013	515014	515015	515016	7522	7527
7529	7532	7533	7534	7535	7548
7550	7553	7555	7556	7571	7572
7575	7576	7577	7578	7579	7580
7581	7582	7585	7586	7590	7591
7596	7597				

VALEO(MOTOROLA)

510-064	510-079	510-157	9AL2572K	9AL2582K	9AL2679K
---------	---------	---------	----------	----------	----------

VALEO(PARIS RHONE)

A13N100	A13N102	A13N135	A13R115	A13R141	A13R152
A13R154	A13R157	A13R170	A13R171	A13R177	A13R178
A13R180	A13R184	A13R186	A13R198	A13R219	A13R223
A13R265	A14R29	A14R47			

**VR-DU511**

\*Voltage Set Point:14.5V

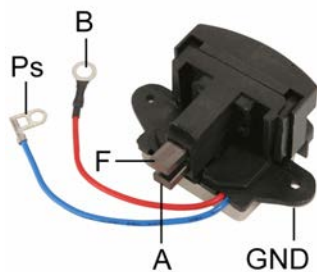

**Replaces**

**CITROEN :**

95546007

**DELCO REMY (LUCAS) :**

21220353

**LUCAS :**

21220253                      UCB206                      UCB207

**RENAULT :**

7701024524                      7701027713                      7701030069

**VALEO :**

NB982

**VALEO(DUCELLIER) :**

511006	511008	511010	511022	511024	581255
581256	690587	690645	690686	691097	691253
691292	691428	691468			

**Unit no.**

VALEO(DUCELLIER)

512008	512010	514011	514012	516006	516008
516009	516015	516016	516017	516020	516023
516024	516025	516026	516029	516030	516033
516034	516042	516045	516047	516048	516049
516058	516062				

**VR-DU512**

\*Voltage Set Point:14.5V

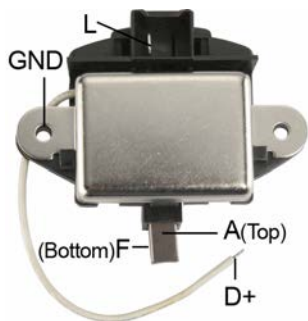

**Replaces**

**LUCAS :**

21220371                      UCB227

**MAGNETI MARELLI :**

940038047

**PEUGEOT :**

5761.48                      5761.49                      5761.61

**VALEO :**

NB926                      NB928

**VALEO(DUCELLIER) :**

511015	511023	581257	582991	691112	691140
691183	691303	691338	691406	691458	691617
694548	694617				

**Unit no.**

VALEO(DUCELLIER)

514005	514007CDE	514010BC	516032	516046	516053
516054	516055	516065			

**VR-DU513**

\*For use on:Renault  
 \*Voltage Set Point:14.5V

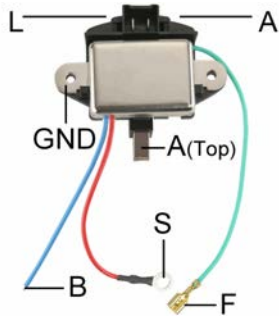

**Replaces**

**LUCAS :**  
 21220379                   UCB235

**VALEO :**  
 NB987

**VALEO(DUCELLIER) :**  
 511018                   691191

**Unit no.**

RENAULT  
 7700670275  
 VALEO(DUCELLIER)  
 516008                   516035A                   516035B

**VR-DU514**

\*Voltage Set Point:14.7V

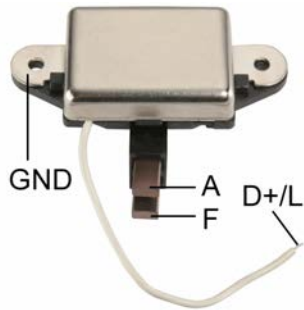

**Replaces**

**VALEO :**  
 NB985                   NB986

**VALEO(DUCELLIER) :**  
 511015                   691146                   691170

**Unit no.**

VALEO(DUCELLIER)  
 516002                   516019                   516027

**VR-DU515**

\*Voltage Set Point:14.7V

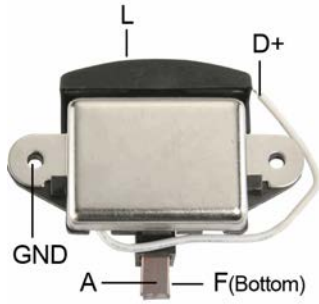

**Replaces**

**DELCO REMY (LUCAS) :**

21220383

**VALEO :**

NB988

**VALEO(DUCELLIER) :**

511015

**Unit no.**

VALEO(DUCELLIER)

516041

**VR-VW002**

\*Voltage Set Point:14.5V

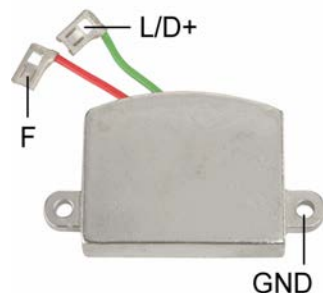

**Replaces**

**AUDI/VW :**

171903803            55903803            55903804

**FORD :**

6048270            77BB-10316AA

**LUCAS :**

21029141            21229047            21229114            21229491            UCB500

**PEUGEOT :**

5761.39

**VALEO :**

592838            505001            505003            505005            505008            505009

505010            505011            505016            505018            505025            505028

505029            505030            505070            505078            505082            505083

505099            505180            NB163            NB165            NB166            NB191

NB193            NB413            NB417            NB431            NB456            NB466

**VALEO(MOTOROLA) :**

9RC2003            9RC2006            9RC7002            9RC7003            9RC7004            9RC7008

9RC7020            9RC7022            9RC7028            9RC7031            9RC7036            9RC7038

9RC7059            9RC7063            9RC7065            9RC7071            9RC7073            9RC7093

**Unit no.**

**VALEO(MOTOROLA)**

10-763	10-764	10-765	10-766	10-767	10-769
10-772	2523160	2523207	2940357	2940361	2940782
510-015	510-031	510-054	510-123	510-146	510-148
510-205	510-246	510-270	510-283	510-296	510-330
510-357	510-401	510-412	510-453	510-455	510-465
9AR2500K	9AR2506K	9AR2512P	9AR2520K	9AR2533P	9AR2539K
9AR2561K	9AR2638P	9AR2672P	9AR2694P	9AR2755P	9AR2759
9AR2805G	9AR2830L	9AR2838L	9AR2862	9AR2867L	9AR2897L
9AR2938T	9AR2990P	9AR2992P	9AR5001K	9AR5037L	9AR5039L
9ASR5043P	9BB2KA2A01	9BB2KB2A02	9BB2KB2A06	9BB2KB2A07	9BE2KA2A14
9BE2KB2A06	9BE2KB2A07	9BE2KB2A08	9BE2KB2A15	9BE2KC2A32	9BE2KD2A40
9BE2NA2A21	9BE2NB2A38	9BE2NE2A41	9FB2KA2A03	9FB2KB2A04	9FB2KB2A06
9FB2LD2A07	9FD2KB2A12	9FD2KC2A35	9FD2LD2A07	9FD2LE2A13	9FD2NA2A19
9FD2NC2A24	9FD2ND2A34	9FD2ND2A42	9FD2NE2A33	9FD2NE2A43	9FD2NF2A37
9FD2NF2A44	9FD2NG2A39	9FD2PA2A16	9FE2KA2A11	9FE2KA2A18	9FE2KB2A07
9FE2KB2A08	9FE2LD2A07	9FE2LD2A08	9FF2LD2A10	9GD2NA2A25	

**VR-VW003**

\*Voltage Set Point:14.5V

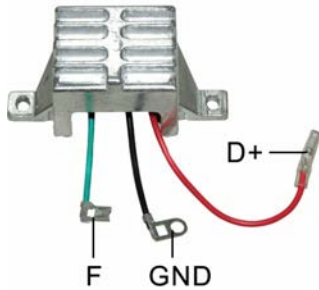

**Replaces**

**AUDI/VW :**  
36903803

**FORD :**  
6073340                    80BB-10316AA

**LUCAS :**  
21229048                    21229142                    UCB501

**VALEO :**  
505019                    505020                    505031                    505032                    505069                    505072  
NB188                    NB414                    NB468

**VALEO(MOTOROLA) :**  
9RC7024                    9RC7025                    9RC7041                    9RC7042                    9RC7056                    9RC7057

**Unit no.**

VALEO(MOTOROLA)					
9AR2683G	9AR2687G	9AR2697D	9AR2698F	9AR2699G	9AR2700G
9AR2701D	9AR2702	9AR2703F	9AR2704F	9AR2705G	9AR2706G
9AR2707G	9AR2708G	9AR2718G	9AR2719G	9AR2726G	9AR2727G
9AR2729G	9AR2750G	9AR2751G	9AR2792G	9AR2814G	9AR2819G
9AR2820G	9AR2821G	9AR2839G	9AR2840D	9AR2841D	9AR2842G
9AR2843G	9AR2847F	9AR2876D	9AR2877F	9AR2878G	9AR2880K
9AR2882F	9AR2883G	9AR2889F	9AR2890G	9AR2895F	9AR2895F02
9AR2895F03	9AR2913D	9AR2914D	9AR2915F	9AR2916F	9AR2917G
9AR2918G	9AR2929G	9AR2960F	9AR2978F		

**VR-VW004**

\*Voltage Set Point:14.5V

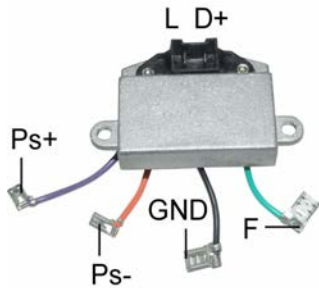

**Replaces**

**LUCAS :**  
21229165                    UCB503

**RENAULT :**  
7701024064

**VALEO :**  
2522098                    505026                    505103                    NB464

**VALEO(MOTOROLA) :**  
9RC7030                    9RC7101

**Unit no.**

VALEO					
433430	433437	433453	436318	510147	510151
510152	510172	510302	510349	510367	9AR2659K
9AR2660K	9AR2675K	9AR2676K	9AR2695K	9AR2760K	9AR2778K
9AR2869K	9AR2933P	9AR2934K	9AR2934P	9AR2935P	9AR2936P
9AR2945K	9AR2948K	9AR2950P	9AR2996P	9AR5023P	9AR5042P

**VR-VW005N**

\*Voltage Set Point:14.5V



**Replaces**

**AUDI/VW :**

026903015E      036903803A      037903803      049903803H

**CHRYSLER :**

2940030

**LUCAS :**

21229199      UCB506

**MAGNETI MARELLI :**

940038151

**VALEO :**

2521760	YV49	YV4904	2519490	2940022	YV99
YV9911	2940318	2519124	2521766	2522098	2522939
2523198	2541484	2940328	2941121	505100	505105
592781	592806	592888	592952	592963	A519124A
A521760A	A940318A	NB492	YV1923		

**VALEO(DUCELLIER) :**

592989      505-100      505-105      592806

**VALEO(MOTOROLA) :**

2522939	2940022	2940030	2940305	2940305A	2940318
9RC2018	9RC2021	9RC7088	9RC7104		

**Unit no.**

AUDI/VW

026903015E

MITSUBISHI MOTORS

9AR2973L

VALEO

026903015EV	026903015EX	026903015EY	049903119L	068903031KV	068903031KX
068903171	2518017	2521682	2541114	2541115	2541187
2541221	2541222	2541233	2541234	2541235	2541236
2541301	2541305	2541334	2541372	2541396	2541402
2541428	2541429	2541430	2541431	2541432	2541438
2541479	2541480	2541481	2541497	2541498	2541499
2541682	2940301	436112	436114	436117	436132
436134	436147	436191	436192	436193	436220
436294	436296	436330	436331	436332	436333
436334	436368	436369	436370	436398	436399
436400	436404	436405	A13E03	A13E04	A13E05
A13E06	A13E07	A13E08	A13E09	A13E10	A13E11
A13E12	A13E13	A13E19	A13E21	A13E22	A13E23
A13E24	A13E25	A13E26	A13E47	A13E48	

VALEO(MOTOROLA)

2940302	2940304	2940305	2940306	2940307	2940308
2940309	2940310	2940311	2940363	2940365	2940367
2940369	2940371	2940373	2940375	2940409	9AL2977
9AR2970K	9AR2971G	9AR2972G	9AR2973L	9AR2974L	9AR2975L
9AR2976K	9AR2977L	9AR5044K	9AR5046G	9AR5081K	9AR5082G
9AR5083G	9AR5084L	9AR5085L	9AR5086L	9AR5087K	9AR5088L
9AR5089G	9AR5090L	9AR5099	9AR5099L	9AR5100G	9AR5101K

VALEO(PARIS RHONE)

A14V01	A14V02	A14V03	A14V04	A14V05	A14V07
A14V08	A14V09	A14V10	A14V11	A14V12	A14V13
A14V14	A14V15	A14V16	A14V17	A14V18	A14V19

**VR-VW005NH**

\*Heavy Duty for Max. 140A Alternators.  
 \*Voltage Set Point:14.5V



**VR-VW006**

\*24V  
 \*Adjustable Voltage  
 \*Voltage Set Point:26.6V~30.0V

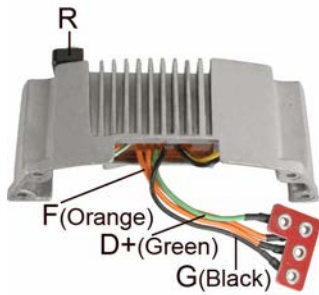

**Replaces**

VALEO(MOTOROLA) :  
 105246            8RL3011

**Unit no.**

VALEO(MOTOROLA)  
 10-298            8SC3014U

**VR-VW007**

\*24V  
 \*Adjustable Voltage  
 \*Voltage Set Point:26.6V~30.0V

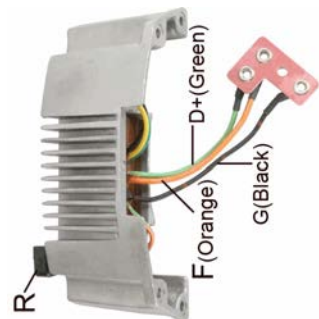

**Replaces**

VALEO(MOTOROLA) :  
 105229            8RL3007

**Unit no.**

VALEO(MOTOROLA)  
 10-258



**VR-VW009**

\*Voltage Set Point:14.5V

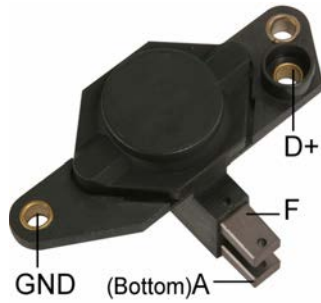

**Replaces**

**MERCEDES-BENZ :**

1500255

**VALEO :**

2518044            592792            YV0913H

**VALEO(MOTOROLA) :**

2541141

**Unit no.**

**MERCEDES-BENZ**

008-154-6708    008-154-8702    008-154-8902

**VALEO**

2518044            2518046            2541297

**VALEO(PARIS RHONE)**

A13V02            A13V05            A13V07

**VR-VW010**

\*Voltage Set Point:14.7V



**Replaces**

**AUDI/VW :**

028903803F      078903803A      078903803B

**LUCAS :**

2131049      UCB245

**MAGNETI MARELLI :**

940038186      943356220      943356220010

**MERCEDES-BENZ :**

21549106

**PEUGEOT :**

5761.87      5761.9

**VALEO :**

YM1949	YM3953	YM6555	YM6952	YM6955	YM9980
YV1928	YV1966T	YV9966T	2545472	593131	593139
593301	593312	593326	593350	2521335	2541392
2541404	2541433	2541493	2541666	2541667	2541682
2541721	2541800	592791	592797	592800	592801
592910	592911	593133	9RC6065	A808422A	NC985
YM1950	YV1965T	YV1969T	YV3970H		

**VALEO(MOTOROLA) :**

9RC6065      9RC2054

**VOLKSWAGEN :**

028903803F      078903803A      078903803B

**VR-VW010**

Unit no.

AUDI/VW

030903023AA	030903023EV	030903023EX	030903023FV	030903023FX	030903023GV
030903023GX	030903023QV	030903023QX	050903017H		

DAIMLER-BENZ

0091545902 91545902

VALEO

2541246	2541299	2541321	2541348	2541355	2541357
2541360	2541361	2541362	2541391	2541405	2541408
2541411	2541412	2541415	2541416	2541417	2541418
2541419	2541420	2541447	2541455	2541457	2541458
2541459	2541461	2541475	2541486	2541494	2541611
2541612	2541617	2541626	2541644	2541646	2541655
2541658	2541665	2541676	2541680	2541683	2541694
2541698	2541699	2541703	2541711	2541719	2541724
2541726	2541731	2541733	2541734	2541736	2541738
2541739	2541740	2541741	2541747	2541758	2541759
2541760	2541763	2541764	2541765	2541767	2541775
2541776	2541784	2541785	2541786	2541793	2541794
2541799	2541801	2541802	2541812	2541814	2541815
2541816	2541817	2541818	2541821	436258	436260
436261	436336	436338	436339	436340	436345
436346	436361	436364	436379	436380	436385
436386	436388	436389	A11VI15	A11VI19	A11VI20
A11VI32	A11VI33	A11VI35	A11VI36	A11VI37	A11VI38
A11VI39	A11VI40	A11VI42	A11VI43	A11VI44	A11VI45
A11VI46	A11VI47	A11VI48	A11VI49	A11VI50	A11VI51
A11VI52	A11VI53	A11VI55	A11VI56	A11VI57	A11VI58
A11VI60	A11VI62	A11VI63	A11VI65	A11VI66	A13VI100
A13VI101	A13VI102	A13VI108	A13VI109	A13VI113	A13VI114
A13VI121	A13VI123	A13VI124	A13VI125	A13VI126	A13VI132
A13VI137	A13VI138	A13VI140	A13VI142	A13VI27	A13VI33
A13VI36	A13VI37	A13VI38	A13VI39	A13VI40	A13VI41
A13VI42	A13VI43	A13VI44	A13VI51	A13VI53	A13VI58
A13VI59	A13VI60	A13VI63	A13VI68	A13VI71	A13VI74
A13VI75	A13VI76	A13VI79	A13VI81	A13VI83	A13VI84
A13VI85	A13VI86	A13VI87	A13VI88	A13VI94	A13VI95
A13VI96	A13VI99	A14VI10	A14VI11	A14VI13	A14VI14

VALEO(PARIS RHONE)

A11VI10	A11VI11	A11VI17	A11VI18	A11VI22	A11VI23
A11VI24	A11VI25	A11VI91	A13VI10	A13VI48	A13VI49
A13VI54	A13VI67	A13VI69	A13VI70		

**VR-PR002H**

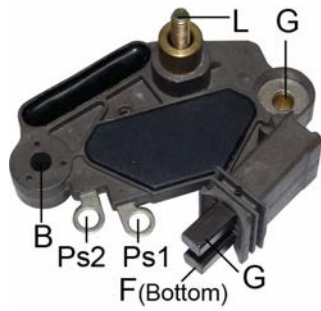

- \*Soft Start
- \*2.5 sec. LRC
- \*Short Circuit Protection
- \*Voltage Set Point:14.6V

**Replaces**

**VALEO :**

593290                    593310                    593349

**VALEO(PARIS RHONE) :**

YM1600

**Unit no.**

VALEO(PARIS RHONE)

A11VI165	A11VI184	A11VI209	A11VI212	A11VI216	A11VI217
A11VI218	A11VI224	A11VI225	A11VI227	A11VI254	A11VI79
A11VI85	A11VI92	A11VI93	A11VI96	A13VI136	A13VI157
A13VI163					

**VR-PR003H**

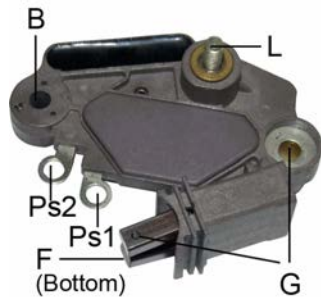

- \*Soft Start
- \*8.5 sec. LRC
- \*Short Circuit Protection
- \*Voltage Set Point:14.6V

**Replaces**

**VALEO :**

593319

**VALEO(PARIS RHONE) :**

YM1919P1

**Unit no.**

VALEO(PARIS RHONE)

A13VI178	A13VI202	A13VI237	A13VI257
----------	----------	----------	----------

**VR-PR1000H**

\*Voltage Set Point:14.5V

L IG

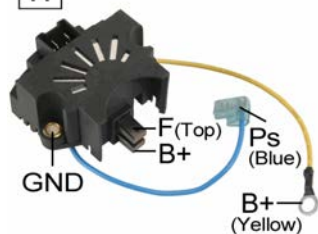

**Replaces**

**ISKRA :**

11-125-113            AER1521

**LUCAS :**

21225345            UCB218                    UCB223                    NCB218

**MAGNETI MARELLI :**

940038162

**RENAULT :**

7701028400        7701029095            7701031737            7701033171            7701348589

**SEV MARCHAL :**

71490602            72590602                    72590702                    72591202

**VALEO :**

2590558	590558	2541137	590679	YH1655	YV1655
2590588	300668	182046	2590588	300668	300795
300806	300868	300894	300901	92860	92927
NC189	NC192				

**VALEO(PARIS RHONE) :**

YH1649	YH1652	YH1654	YL122	YL129	YL149
YL152	YL154	YL155	YV1652	YV1654	YM1652

**Unit no.**

**SEV MARCHAL**

71651902            71652402                    71652602

**VALEO(PARIS RHONE)**

A13N104	A13N106	A13N107	A13N108	A13N110	A13N113
A13N116	A13N117	A13N119	A13N12	A13N120	A13N121
A13N124	A13N126	A13N13	A13N137	A13N139	A13N14
A13N15	A13N17	A13N18	A13N19	A13N20	A13N27
A13N29	A13N30	A13N31	A13N49	A13N50	A13N53
A13N6	A13N64	A13N65	A13N81	A13N85	A13N86
A13N87	A13N88	A13N89	A13N90	A13N97	A13R218
A13R221	A13R222	A13R228	A13R230	A13R231	A13R242
A13R243	A13R247	A13R255	A13R256	A13R258	A13R260
A13R270	A14E25T	A14E45	A14N102	A14N113	A14N117
A14N12	A14N13	A14N14	A14N50	A14N51	A14N53
A14N54	A14N56	A14N60	A14N62	A14N63	A14N64
A14N65	A14N69	A14N70	A14N76	A14N77	A14N85
A14N86	A14N88	A14N89	A14N95	A14N96	A14N97
A14N99					

**VR-PR1060H**

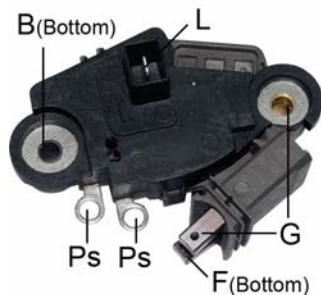

- \*Soft Start
- \*8.5 sec. LRC
- \*Short Circuit Protection
- \*Voltage Set Point:14.2V

**Replaces**

**VALEO :**  
 593305                    593318  
**VALEO(PARIS RHONE) :**  
 YM10607P            YM1606P1            YV1060P

**Unit no.**

VALEO(PARIS RHONE)  
 A13V1151

**VR-PR120**

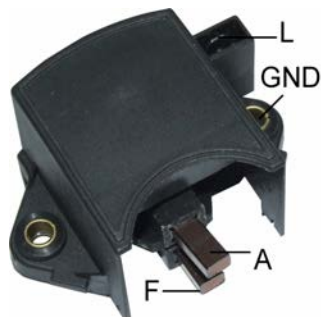

- \*Voltage Set Point:14.5V

**Replaces**

**MAGNETI MARELLI :**  
 940038164  
**VALEO :**  
 92856                    92913                    97729                    NC168                    NC170                    NC173  
**VALEO(PARIS RHONE) :**  
 YL120                    YL121                    YL127

**Unit no.**

VALEO  
 2094803                    2097853                    2098190                    2098621                    2098624                    2099199  
 2099427                    2099751                    2100060  
 VALEO(PARIS RHONE)  
 A1235                    A12R30                    A12R31                    A12R32                    A12R37                    A12R41  
 A13R192                    A13R214                    A14R10T                    A14R14T                    A14R26                    A14R28  
 A14R35                    A14R41

**VR-PR123**

\*Voltage Set Point:14.5V

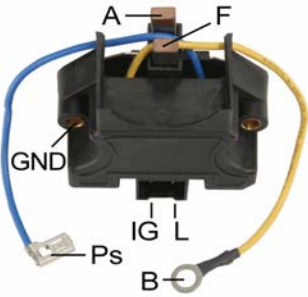

**Replaces**

**LUCAS :**

21225423

**VALEO :**

300669                      92867

**VALEO(PARIS RHONE) :**

YL123                      YL123B                      YL134                      YL143

**Unit no.**

**VALEO(PARIS RHONE)**

2098216	2098482	2102159	2102160	A12M11	A12M16
A12M17	A12M9				

**VR-PR124**

\*To be replaced by VR-PR2000H  
\*Voltage Set Point:14.5V

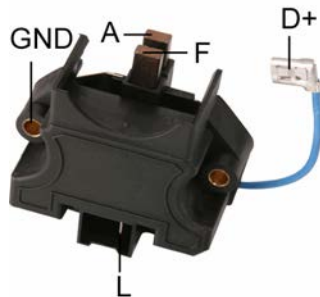

**VR-PR126**

\*Voltage Set Point:14.5V

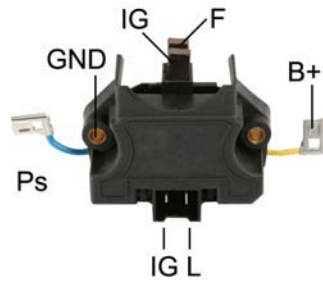

**Replaces**

**DELCO REMY (LUCAS) :**

21225422

**RENAULT :**

7701030814

**VALEO :**

182005	182011	2590558	300725	300883	590660
92937	92982	92990	A518052A	NC175	NC176
NC191	YV1654				

**VALEO(PARIS RHONE) :**

YH1639	YH2602	YH2605	YH2606	YL126	YL138
YL139	YL151	YV126	YV1652	YV2605	

**Unit no.**

VALEO(PARIS RHONE)

A13N10	A13N43	A13N69	A13N76	A13N92	A14N10
A14N22	A14N35	A14N36	A14N37	A14N55	A14N59
A14N73	A14N75	A14N76	A14N83	A14N84	A14N9
A14N95					

**VR-PR127B**

\*24V  
\*Voltage Set Point:28.3V

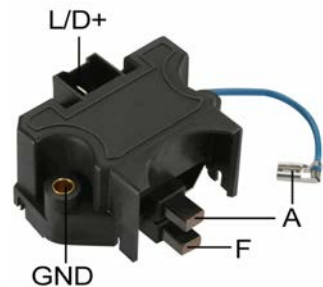

**Replaces**

**PEUGEOT :**

5761.51

**VALEO :**

92955                      NC692

**VALEO(PARIS RHONE) :**

ZL127

**Unit no.**

VALEO(PARIS RHONE)

A12R35T	A14R341T	A14R34T	A14R541T	A14R542T	A14R543T
A14R54T					



**VR-PR128**

\*Voltage Set Point:14.5V

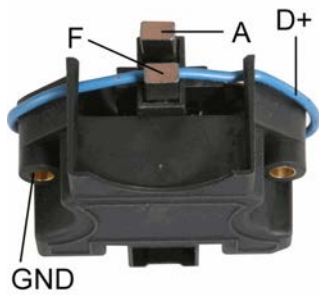

**Replaces**

**VALEO :**

182007                    182013                    300663                    300685                    92991

**VALEO(PARIS RHONE) :**

YH1903                    YH1928                    YL128                    YL137                    YL145                    YV1903

**Unit no.**

**VALEO(PARIS RHONE)**

A13N165                    A13N21T                    A13N26                    A13N34                    A13N52                    A13N80  
A13N93

**VR-PR128B**

\*24V  
\*Voltage Set Point:28.3V

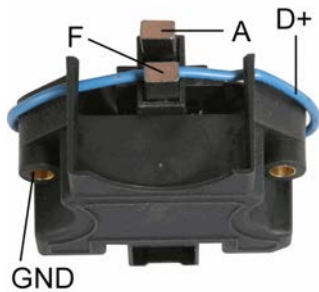

**Replaces**

**LUCAS :**

UCB237

**VALEO :**

ZL126                    ZL128                    ZV3928                    590640                    92901                    92962

A541184A                    NC171                    092962Y

**VALEO(PARIS RHONE) :**

ZL126                    ZL128                    ZV3928

**Unit no.**

**VALEO(PARIS RHONE)**

A13N11                    A13N174                    A13N190                    A13N22T                    A13N4T                    A13N5T  
A14N104                    A14N133                    A14N135                    A14N138                    A14N39                    A14R33

**VR-PR130**

\*Voltage Set Point:14.5V

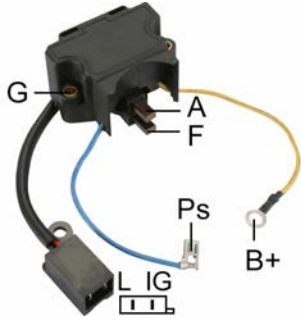

**Replaces**

**SEV MARCHAL :**  
72591502

**VALEO :**  
300667                      300675                      300676                      92918                      92930                      92933

**VALEO(PARIS RHONE) :**  
YL130                      YL131                      YL136                      YL140                      YL141                      YL142

**Unit no.**

VALEO(PARIS RHONE)  
A12R38                      A12R46                      A14N1                      A14N2                      A14R35                      A14R37  
A14R42                      A14R46

**VR-PR132B**

\*24V  
\*Voltage Set Point:28.3V



**Replaces**

**VALEO :**  
182008                      2590537

**VALEO(PARIS RHONE) :**  
YV3932                      ZL132                      ZL134                      ZV3932

**Unit no.**

VALEO  
2101823                      2181757                      2181758                      2181759                      2181760                      2541660  
436352  
VALEO(PARIS RHONE)  
A13N140T                      A13N141T                      A13N142T                      A13N256                      A13N51                      A14N114T

**VR-PR135**

\*Voltage Set Point:14.5V



**Replaces**

**LUCAS :**

UCB243

**VALEO :**

YV77                      YV7735                      2590512                      300692                      300741                      92966

NC362                      NC927                      590512

**VALEO(PARIS RHONE) :**

YL135                      YL146                      YL147

**Unit no.**

VALEO(PARIS RHONE)

A13N28M                      A14N48M                      A14N66M

**VR-PR135B**

\*24V  
\*Voltage Set Point:28.3V



**Replaces**

**LUCAS :**

21225372                      UCB239

**VALEO :**

300744                      NC184

**VALEO(PARIS RHONE) :**

ZL129

**Unit no.**

VALEO(PARIS RHONE)

A13N143M                      A13N152M                      A13N36M                      A13N56M                      A13N59M                      A14N112M

A14N115M                      A14N116M                      A14N206M

**VR-PR135BA**

\*24V  
 \*Adjustable Voltage  
 \*Voltage Set Point:25.0~30.0V

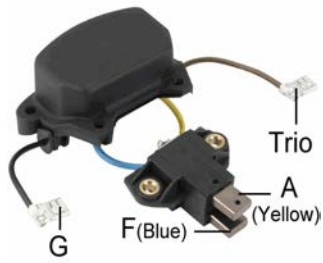

**Replaces**

**LUCAS :**  
 21225372                      UCB239

**VALEO :**  
 300744                          NC184

**VALEO(PARIS RHONE) :**  
 ZL129

**Unit no.**

VALEO(PARIS RHONE)

A13N33M	A13N36M	A13N59M	A14N122M	A14N137M	A14N141M
A14N30M	A14N47M	A14N81M			

**VR-PR1424H**

\*Voltage Set Point:14.6V  
 \*w/o Choke

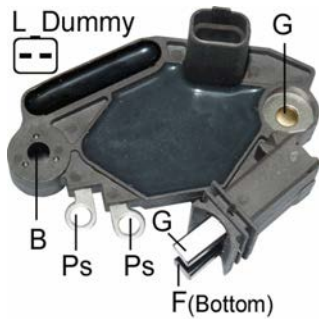

**VR-PR152A**

\*To be Replaced by VR-PR1652/PR-1652H  
 \*Voltage Set Point:14.5V

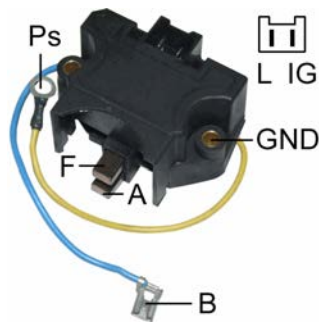

**VR-PR1601H**



- \*Soft Start
- \*2.5 sec. LRC
- \*Short Circuit Protection
- \*Voltage Set Point:14.6V

**Replaces**

**VALEO :**  
593141

**VALEO(PARIS RHONE) :**  
YM1601T

**Unit no.**

VALEO(PARIS RHONE)

A11VI54	A11VI76	A11VI77	A13VI117	A13VI118	A13VI122
A13VI139	A13VI148	A13VI149			

**VR-PR1620H**



- \*W/ Choke
- \*Voltage Set Point:14.6V

**Replaces**

**VALEO :**

593316	593338	593411	9RC7108	YM1424P1	YM1620
YM1622P	YM1662P				

**Unit no.**

VALEO(PARIS RHONE)

2541946	2541947	2541953	2541954	2541980	2542252
2542275	2542302	2542322	2542325	2542326	2542327
2542354	2542464	2542480	2542495	2542551	2542552
2542553	2542645	2542691	436712	436742	436748
436750	437112	437119	437168	437183	437196
437197	437200	437306	437323	437347	437353
437408	439215	439230	439266	439280	439281
439284	439302	A11VI110	A11VI111	A11VI87	A11VI88
A11VI94	A11VI98	A13VI188	A13VI195	A13VI235	A13VI238
A13VI249	A13VI251	A13VI252	A13VI253	A13VI259	A13VI285
A13VI289	A13VI290	A13VI291	A13VI297	A13VI300	

**VR-PR1667**

\*Voltage Set Point:14.7V

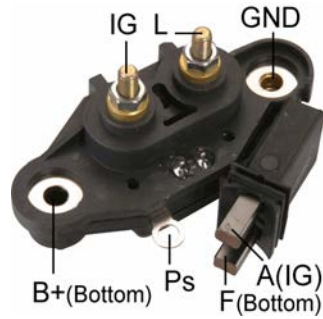

**Replaces**

**VALEO :**

2541406	2541496	592793	9RC2055	9RC2062	A808239A
NC987	YV1867H				

**VALEO(PARIS RHONE) :**

YV1667H

**Unit no.**

**VALEO(PARIS RHONE)**

A11VI28	A11VI31	A13VI21	A13VI11	A13VI14	A13VI16
A13VI17	A13VI20	A13VI23	A13VI25	A13VI28	A13VI31
A13VI32	A13VI34	A13VI35	A13VI45	A13VI47	

**VR-PR1669**

\*Voltage Set Point:14.7V

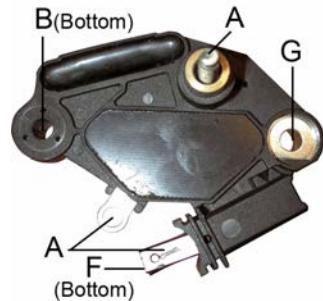

**Replaces**

**VALEO :**

2541715	2541715B	2808323	5931138	NF076	RTM151A
---------	----------	---------	---------	-------	---------

**VALEO(MOTOROLA) :**

9RC6074

**VALEO(PARIS RHONE) :**

YM6951

**Unit no.**

**VALEO**

2541678	2541679	A13V172	A13V173
---------	---------	---------	---------

**VR-PR1671**

\*Voltage Set Point:14.2V

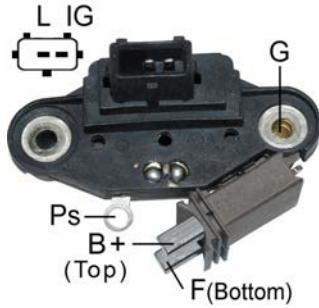

**Replaces**

**VALEO :**  
593132                    593140  
**VALEO(PARIS RHONE) :**  
YV10673H                YV3670

**Unit no.**

VALEO(PARIS RHONE)  
A13VI97

**VR-PR1926**

\*Voltage Set Point:14.7V

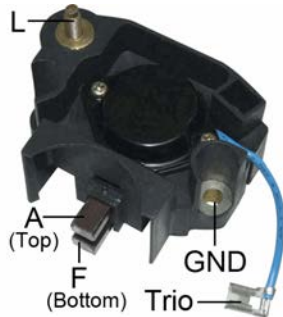

**Replaces**

**CITROEN :**  
9405761798  
**VALEO :**  
2541192                2541193                590688                9RC2047                YV1926  
**VALEO(PARIS RHONE) :**  
YV1926T

**Unit no.**

VALEO(PARIS RHONE)  
A13N184                A14N139                A14N172

**VR-PR1935**

\*Soft Start  
\*8.5 sec. LRC  
\*Short Circuit Protection  
\*Voltage Set Point:14.8V



**Replaces**

**VALEO :**  
593342                    2541935B

**Unit no.**

GM  
10246634  
VALEO  
2542445A                A14VI21                A14VI39

**VR-PR2000H**

\*Voltage Set Point:14.5V

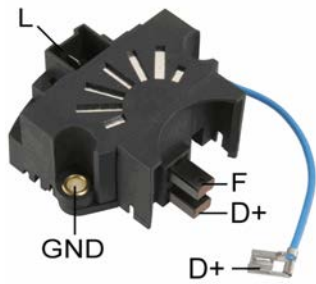

**Replaces**

**LUCAS :**

21225183                   UCB220

**MAGNETI MARELLI :**

940038161

**PEUGEOT :**

5761.56

**SEV MARCHAL :**

72590902

**VALEO :**

590538	590704	592803	593191	182120	2590538
2590542	300820	300830	300884	92897	92902
92940	92981	NC178	NC187	NC313	

**VALEO(PARIS RHONE) :**

YH1925	YH1933	YH2701	YH2925	YL124	YL125
YL132	YL133	YV1924	YV2925	YV1933	

**VOLVO :**

3343913

**Unit no.**

**VALEO(PARIS RHONE)**

A12R22	A12R33	A12R52	A13N32	A13N39	A13N41
A13R267	A13R268	A14N16	A14N23	A14N78	A14N80
A14N88	A14N91				

**VR-PR2206**

\*Soft Start  
 \*3 Sec. LRC  
 \*Short Circuit Protection  
 \*Voltage Set Point:14.6V



**Replaces**

**VALEO :**

2543327B                   595211

**Unit no.**

**BOSCH**

0-986-045-031

**VALEO**

2542812A	2542826A	2542812	2542826	SG14B020
----------	----------	---------	---------	----------



**VR-PR2222**

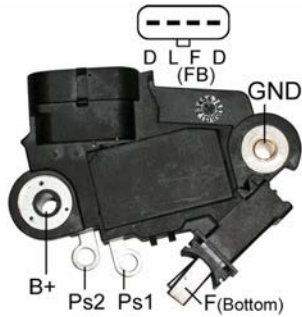

- \*Soft Start
- \*8.5 sec. LRC
- \*Short Circuit Protection
- \*Voltage Set Point:14.8V

**Replaces**

**VALEO :**  
2542222B

**VR-PR2288**

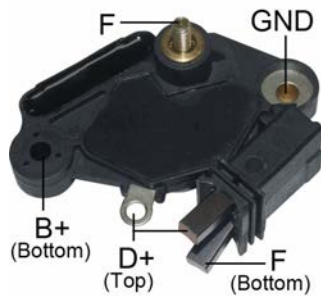

- \*Voltage Set Point:14.7V

**Replaces**

**VALEO :**  
2542288                      593375  
**VALEO(PARIS RHONE) :**  
YM6956

**VR-PR2292H**

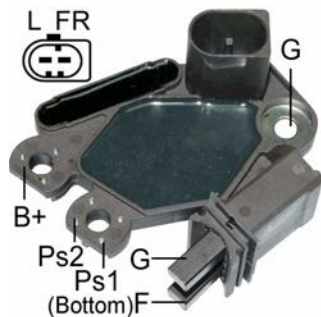

- \*B-Circuit
- \*Soft Start
- \*2.5 sec. LRC
- \*Short Circuit Protection
- \*Voltage Set Point:14.7V

**Replaces**

**AUDI :**  
06B903803            06B903803A            06B903803B            078903803C  
**VALEO :**  
2605597            593455            593941            593371            593455            593480  
593522            593813            593940            593941            593942  
**VALEO(PARIS RHONE) :**  
YM1626F            YM1672

**Unit no.**

**VALEO**  
2542234            2542227            2542233C            2542324            437173            437358  
439260            SG12B011            SG12B025            SG12B054            CVS082613            CVS082593  
CVS082576            TG11S115            04E-903-023N  
**VALEO(PARIS RHONE)**  
SG12B010            SG12B011            SG12B015            SG12B018            SG12B042            SG12B047  
SG9B010            SG9B011            SG9B013            SG9B015            SG9B018            SG9B019  
SG9B023            SG9B042  
**VOLKSWAGEN**  
06J-903-023C            03C-903-025D            03C-903-023B

**VR-PR2293**



- \*B-Circuit
- \*Soft Start
- \*2.5 sec. LRC
- \*Short Circuit Protection
- \*Plug is different from VR-PR2292H
- \*Voltage Set Point:14.6V

**Replaces**

VALEO :  
593943

Unit no.

VALEO  
SG12B024

**VR-PR2299H**

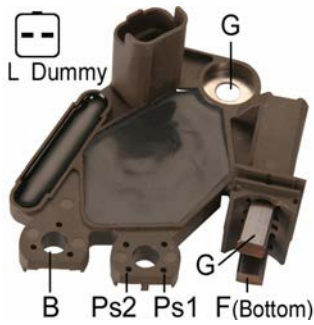

\*Voltage Set Point:14.6V

**Replaces**

VALEO :  
2542299            593384            593396            YM1636P1

Unit no.

VALEO  
2542270            2542466  
VALEO(PARIS RHONE)  
SG10B010        SG10B011        SG10B016        SG10B019        SG10B020        SG10B031  
SG10B032        SG12B017        SG12B030

**VR-PR2339**



- \*Soft Start
- \*8.5 sec. LRC
- \*Short Circuit Protection
- \*Voltage Set Point:14.8V

**Replaces**

VALEO :  
2542339B

Unit no.

VALEO  
A14VI63            SA14VI63



**VR-PR3389**

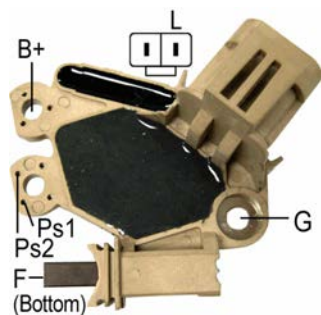

- \*B-Circuit
- \*Inactive Lamp
- \*Soft Start
- \*8 sec. LRC
- \*Short Circuit Protection
- \*Voltage Set Point:14.6V

**Replaces**

VALEO :

593389                      593818                      2542213                      2548923

**Unit no.**

HYUNDAI  
37300-37250  
VALEO  
439295

**Used On**

**HYUNDAI**

Sonata	2.5L	2000-2001
Sonata	2.7L	2002-

**KIA**

Optima	2.5L	2001-
Optima	2.7L	2002-2004

**VR-PR3430**

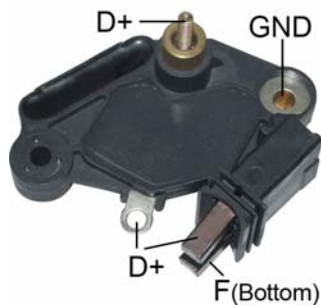

- \*24V
- \*Voltage Set Point:28.3V

**Replaces**

VALEO :

2542419                      593430

VALEO(PARIS RHONE) :

ZV3963T

**Unit no.**

VALEO		
2542433	2542479	2542493
VALEO(PARIS RHONE)		
HD90S013	HD90S014	HD90S015

**VR-PR3529**

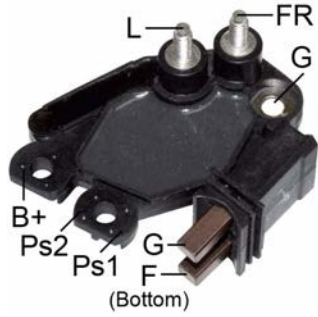

- \*Soft Start
- \*2.5 sec LRC
- \*Short Circuit Protection
- \*Self Exciting
- \*Voltage Set Point:14.6V

**Replaces**

**VALEO :**  
593529

**Unit no.**

VALEO  
2542485A      9642879480

**VR-PR3534**



- \*Soft Start
- \*2.5 sec LRC
- \*Short Circuit Protection
- \*Voltage Set Point:14.6V

**Replaces**

**VALEO :**  
593477      593505      593534      YR 6604      YR66P      2542934

**Unit no.**

VALEO  
2542414A      2542489      2542489A      2542564      SG10B041      SG15S021  
SG15S022      SG7S014      SG7S024      SG8B020      TG15C015

**VR-PR3617H**

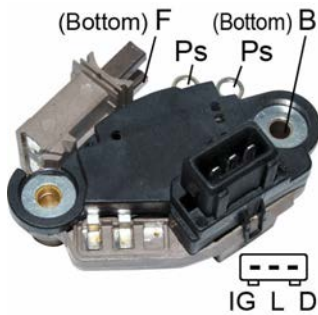

- \*Voltage Set Point:14.5V

**Replaces**

**VALEO :**  
2542204      593333      2542209B      593347      593391

**VALEO(PARIS RHONE) :**  
YM2618P1      YM3617PIC

**Unit no.**

VALEO(PARIS RHONE)  
A13V1150      A13V1160

**VR-PR3729A**

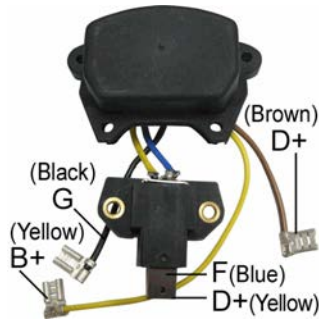

\*24V  
 \*Voltage Set Point: 27.8V+/- 0.3V  
 \*Adjustable Voltage

**Replaces**

**MAGNETI MARELLI :**

940038173

**VALEO :**

590536

**VALEO(PARIS RHONE) :**

A14N100M	A14N119M	A14N122M	A14N137	A14N141M	ZV 3729
ZY 3729					

**Unit no.**

VALEO

2102052	2180619	2180620	2181991	2541168	2541199
A14N100M	A14N119M	A14N122M	A14N137	A14N137M	A14N141M
A14N200	A14N200M	A14N30M	A14N33M	A14N81M	

**VR-PR3960**

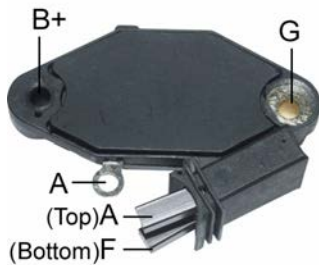

\*24V  
 \*Voltage Set Point:28.3V

**Replaces**

**VALEO :**

593260

**VALEO(PARIS RHONE) :**

ZV3960H

**Unit no.**

VALEO(PARIS RHONE)

A14V119



**VR-PR5023**

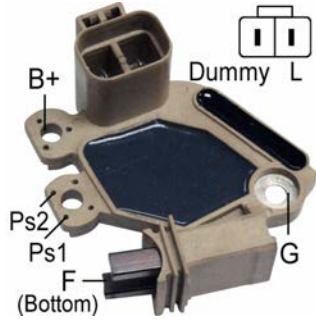

- \*B-Circuit
- \*Inactive Lamp
- \*Short Circuit Protection
- \*Voltage Set Point:14.5V

**Replaces**

**HYUNDAI :**  
37370-22650  
**VALEO :**  
2607089

**Unit no.**

HYUNDAI  
37300-22650  
VALEO  
A0002655023      2655023

**Used On**

<b>HYUNDAI</b>		
Accent	1.6L	2003-2007
Elantra	2.0L	2005-2006
Tiburon	2.0L	2004-2007
Tucson	2.0L	2005-2007
<b>KIA</b>		
Rio	1.6L	2006-2007
Spectra	2.0L	2004-2007
Sportage	2.0L	2005-2007

**VR-PR6366**

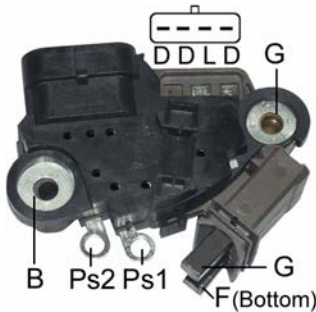

- \*Voltage Set Point:14.6V
- \*Soft Start
- \*8.5 Second LRC
- \*Short Circuit Protected

**Replaces**

**VALEO :**  
2546366C      2546493C

**Unit no.**

DELCO  
10295859  
VALEO  
439218  
VALEO(PARIS RHONE)  
A13VI147      A13VI194



**VR-PR6603H**

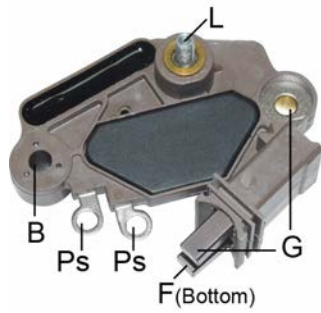

- \*Soft Start
- \*2.5 sec. LRC
- \*Short Circuit Protected
- \*Voltage Set Point:14.6V

**Replaces**

**VALEO :**  
593284

**Unit no.**

VALEO  
2542500

**VR-PR7736**

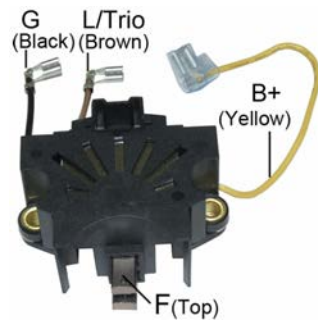

- \*Voltage Set Point:14.5V

**Replaces**

**VALEO :**  
593135

**VALEO(PARIS RHONE) :**  
YV7736

**Unit no.**

VALEO(PARIS RHONE)  
A13N234          A13N259          A13N285

**VR-VN001**

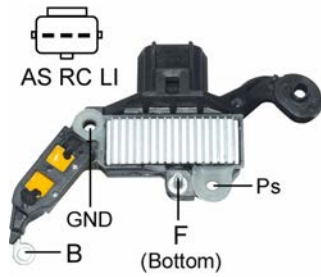

- \*A-Circuit
- \*Voltage Set Point:14.0V
- \*Regulated Voltage Control(RVC)
- \*Requires RVC01 tester box for testing

Unit no.

FORD  
1S7T-10300BA 1S7T-10300BB 1S7T-10300BC  
VISTEON  
20-150-01005

Used On

FORD  
Focus 2.3L 2003-2004

**VR-VN002**



- \*A-Circuit
- \*S-D-L Terminals
- \*Soft Start
- \*Short Circuit Protection
- \*Voltage Set Point:14.5V

Unit no.

FORD  
2S6T-10300FA 3N21-10300BB XS611-0300BD XS611-0300BE XS611-0300BG

**VR-VN005**



- \*Soft Start
- \*Short Circuit Protection
- \*Voltage Set Point: 14.5V

Replaces

FORD :  
BF0A-10376AA

Unit no.

VISTEON  
20-150-01011

**VR-H2005-10S**

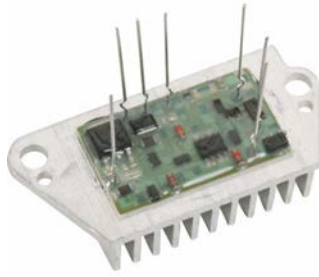

\*Repairs:  
\*VR-H2005-10  
\*Voltage Set Point:14.4V

**VR-H2005-15S**

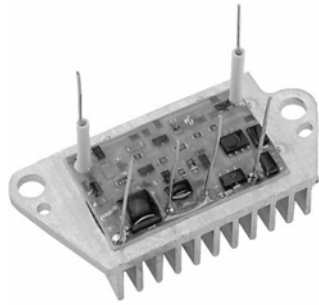

\*Repairs:  
\*VR-H2005-15H  
\*VR-H2005-24  
\*Voltage Set Point: 14.4V

**VR-H2005-18AS**



\*Repairs:  
\*VR-H2005-18A  
\*VR-H2005-63A  
\*VR-H2005-31A  
\*Voltage Set Point:14.6V

**VR-H2005-22S**

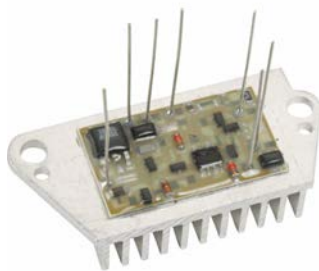

\*Repairs:  
\*VR-H2005-22  
\*VR-H2005-40  
\*Voltage Set Point:14.6V

**VR-H2005-23AS**

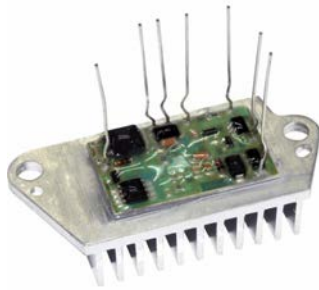

\*Repairs:  
\*VR-H2005-23A  
\*Voltage Set Point:14.6V

**VR-H2005-25S**

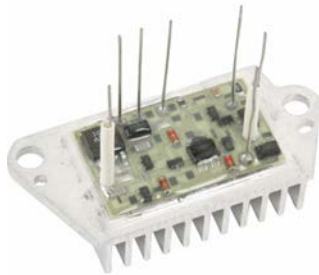

\*Repairs:  
\*VR-H2005-25  
\*Voltage Set Point:14.4V

**VR-H2005-26AS**



\*Repairs:  
\*VR-H2005-26A  
\*VR-H2005-39  
\*Voltage Set Point:14.6V

**VR-H2005-33AS**

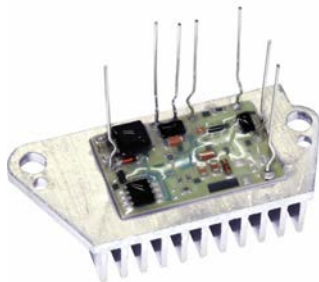

\*Repairs:  
\*VR-H2005-33A  
\*VR-H2005-46A  
\*Voltage Set Point:14.6V

**VR-H2005-3S**



\*Repairs:  
\*VR-H2005-3  
\*VR-H2005-28  
\*VR-H2005-29  
\*Voltage Set Point:14.5V

**VR-H2005-48AS**

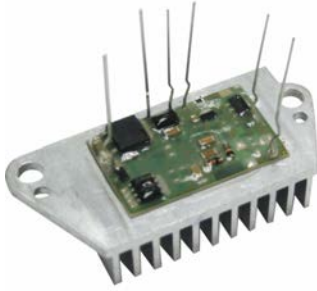

\*Repairs:  
\*VR-H2005-48A  
\*Voltage Set Point:14.6V

**VR-H2005-4AS**



\*Repairs:  
\*VR-H2005-4A  
\*VR-H2005-45A  
\*Voltage Set Point:14.6V

**VR-H2005-5S**



\*Repairs:  
\*VR-H2005-5H  
\*VR-H2005-14H  
\*VR-H2005-16  
\*VR-H2005-47  
\*Voltage Set Point:14.4V

**VR-H2005-62AS**



\*Repairs:  
\*VR-H2005-62A  
\*Voltage Set Point:14.6V

**VR-H2005-6S**

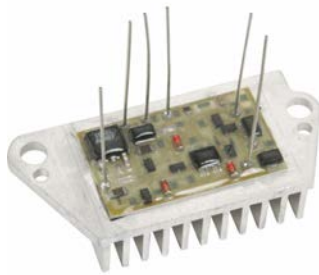

\*Repairs:  
\*VR-H2005-6H  
\*Voltage Set Point:14.4V

**VR-H2005-7S**



\*Repairs:  
\*VR-H2005-7

**VR-H2005-9AS**

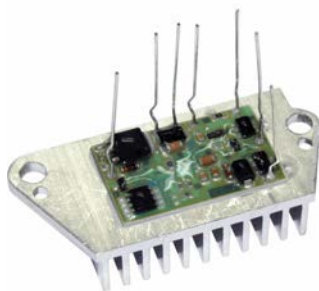

\*Repairs:  
\*VR-H2005-9A  
\*Voltage Set Point:14.6V

**VR-H2000-10S**



\*Repairs:  
\*VR-H2000-4H  
\*VR-H2000-10  
\*VR-H2000-21  
\*Voltage Set Point:14.5V

**VR-H2000-13S**



\*Repairs:  
\*VR-H2000-6H  
\*VR-H2000-13  
\*Voltage Set Point:14.5V

**VR-H2000-14S**

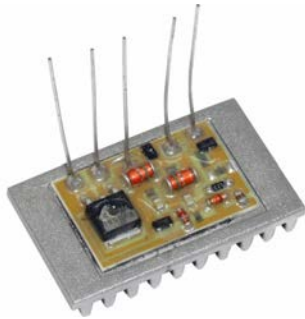

\*Repairs:  
\*VR-H2000-14  
\*Voltage Set Point:14.5V

**VR-H2000-15S**



\*Repairs:  
\*VR-H2000-15  
\*Voltage Set Point:14.5V

**VR-H2000-17S**

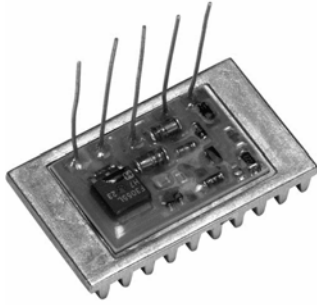

\*Repairs:  
\*VR-H2000-17  
\*Voltage Set Point:14.5V

**VR-H2000-18S**



\*VR-H2000-18  
\*Voltage Set Point:14.5V

**VR-H2000-23S**



\*Repairs:  
\*VR-H2000-23  
\*VR-H2000-16  
\*Voltage Set Point:14.5V

**VR-H2000-28S**



\*Repairs:  
\*VR-H2000-27  
\*VR-H2000-28  
\*Voltage Set Point:14.5V



**VR-H2000-38S**



- \*Repairs:
- \*VR-H2000-38
- \*Voltage Set Point: 14.5V
- \*W/o Overvoltage/Undervoltage indication
- \*W/o Short Circuit Protection

**VR-H2000-41S**

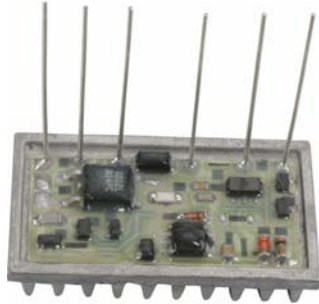

- \*Repairs:
- \*VR-H2000-41

**VR-H2000-44S**

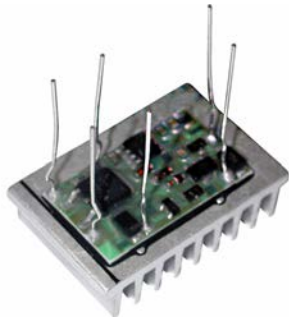

- \*Repairs:
- \*VR-H2000-44
- \*Voltage Set Point: 14.5V

**VR-H2000-46S**



- \*Repairs:
- \*VR-H2000-46
- \*Voltage Set Point: 14.5V

**VR-H2000-48S**

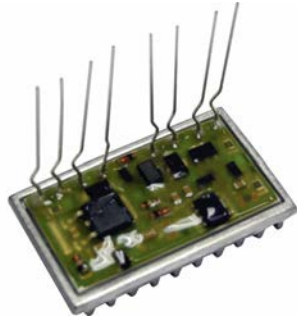

\*Repairs:  
\*VR-H2000-48

**VR-H2000-52S**



\*Repairs:  
\*VR-H2000-52  
\*Voltage Set Point:14.3V

**VR-H2000-55BS**

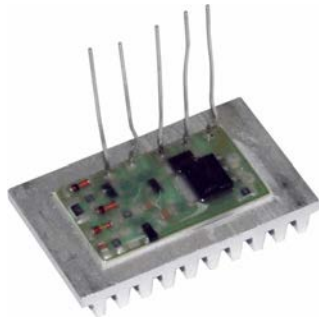

\*Repairs:  
\*VR-H2000-55  
\*Voltage Set Point:28.5V

**VR-H2000-57S**



\*Repairs:  
\*VR-H2000-57  
\*Voltage Set Point:14.3V

**VR-H2000-5S**



\*Repairs:  
\*VR-H2000-5H

**VR-H2000-9S**



\*Repairs:  
\*VR-H2000-9  
\*VR-H2000-12  
\*VR-H2000-65  
\*Voltage Set Point:14.5V

**VR-H2009-86S**

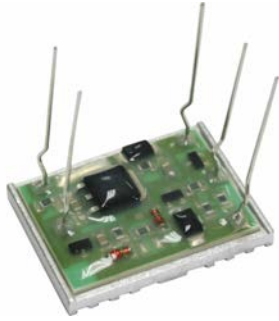

\*Repairs:  
\*VR-H2009-86  
\*Voltage Set Point:14.2V

**VR-MD07S**



\*Repairs:  
\*VR-MD07  
\*Voltage Set Point:14.4V

**VR-H2009-105S**



\*Repairs:  
VR-H2009-105

**VR-H2009-108S**



\*Repairs:  
VR-H2009-108 with A/M Housing

**VR-H2009-10AS**



\*Repairs:  
\*VR-H2009-10N  
\*VR-H2009-24  
\*VR-H2009-25  
\*VR-H2009-26  
\*VR-H2009-33  
\*VR-H2009-35  
\*Voltage Set Point:14.6V

**VR-H2009-112S**

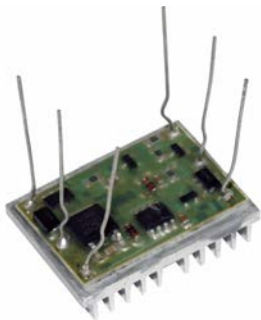

\*Repairs:  
\*VR-H2009-112  
\*Voltage Set Point:14.5V

**VR-H2009-115S**



\*Repairs:  
VR-H2009-108 with OE Housing

**VR-H2009-11S**



\*Repairs:  
\*VR-H2009-11H  
\*VR-H2009-41  
\*Voltage Set Point:14.6V

**VR-H2009-14NS**



\*Repairs:  
\*VR-H2009-14N  
\*Voltage Set Point:14.6V

**VR-H2009-159S**



\*Repairs:  
VR-H2009-159

**VR-H2009-15S**



\*Repairs:  
\*VR-H2009-15  
\*Voltage Set Point:14.5V

**VR-H2009-20S**



\*Repairs:  
\*VR-H2009-20  
\*Voltage Set Point:14.6V

**VR-H2009-38S**



\*Repairs:  
\*VR-H2009-38  
\*Voltage Set Point:14.5V

**VR-H2009-40S**



\*Repairs:  
\*VR-H2009-40  
\*Voltage Set Point:14.6V

**VR-H2009-43S**



\*Repairs:  
\*VR-H2009-22  
\*VR-H2009-37  
\*VR-H2009-43  
\*Voltage Set Point:14.5V

**VR-H2009-44S**



\*Repairs:  
\*VR-H2009-44  
\*Voltage Set Point:14.7V

**VR-H2009-45S**

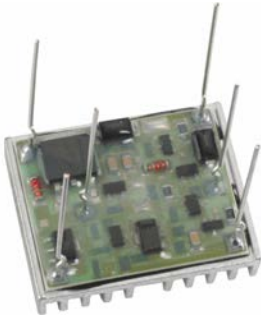

\*Repairs:  
\*VR-H2009-45  
\*Voltage Set Point:14.5V

**VR-H2009-49S**



\*Repairs:  
\*VR-H2009-49  
\*Voltage Set Point:14.6V



**VR-H2009-4S**



- \*Repairs:
- \*VR-H2009-4H
- \*VR-H2009-9H
- \*VR-H2009-13H
- \*Voltage Set Point:14.7V

**VR-H2009-50S**



- \*VR-H2009-50
- \*Voltage Set Point:14.5V

**VR-H2009-58S**



- \*Repairs:
- \*VR-H2009-58
- \*Voltage Set Point:14.6V

**VR-H2009-5S**



- \*Repairs:
- \*VR-H2009-5H
- \*VR-H2009-31
- \*VR-H2009-6H
- \*VR-H2009-28
- \*Voltage Set Point:14.6V

**VR-H2009-70AS**



\*Repairs:  
\*VR-H2009-70A  
\*Voltage Set Point:14.4V

**VR-H2009-73S**



\*Repairs:  
\*VR-H2009-73  
\*Voltage Set Point:14.4V

**VR-H2009-7S**



\*Repairs:  
\*VR-H2009-7H  
\*VR-H2009-27  
\*VR-H2009-8H  
\*VR-H2009-23  
\*Voltage Set Point:14.6V

**VR-H2009-82S**



\*Repairs:  
\*VR-H2009-82  
\*Voltage Set Point:14.7V

**VR-H2009-88S**

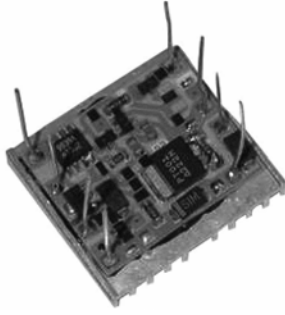

\*Repairs:  
\*VR-H2009-88  
\*Voltage Set Point:14.5V  
\*VR-H2009-88LS  
\*Voltage Set Point:14.4V

**VR-H2009-89S**



\*Repairs:  
\*VR-H2009-89  
\*Voltage Set Point:14.3V

**VR-H2009-94S**

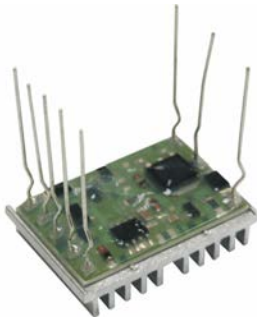

\*Repair:  
\*VR-H2009-94  
\*Voltage Set Point:14.5V

**VR-H2009-95S**

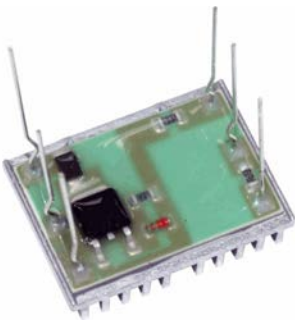

\*Repairs:  
\*VR-H2009-95

VR-H2009-99S



- \*Repairs:
- \*VR-H2009-99
- \*Voltage Set Point:14.5V

**RB-01HA**



\*114mm OD  
\*6-35 Amp Diodes

**Replaces**

**ALFA ROMEO :**

701655

**AUDI/VW :**

028903359A	036903359B	046903359B	049903359E	049903359F	052903371A
056903371A	059903371A	059903371B	28903359	49903359	52903371
56903371	59903359	59903511	9861217187	9861217187F	

**BMW :**

12311354682

**BOSCH :**

1127011130	1127320312	1127011112	1127011113	1127011114	1127011115
1127011135	1127320101	1127320103	1127320105	1127320108	1127320119
1127320120	1127320125	1127320130	1127320134	1127320136	1127320138
1127320140	1127320143	1127320144	1127320145	1127320155	1127320157
1127320158	1127320160	1127320163	1127320174	1127320175	1127320176
1127320178	1127320181	1127320183	1127320185	1127320277	1127320307
1127320310	1127320311	1127320314	1127320322	1127320323	1127320329
1127320339	1127320341	1127320351	1127320355	1127320377	1127320378
1127320380	1127320381	1127320382	1127320392	1127320502	1127320512
1127320513	1127320528	1127320536	1127320554	1127320563	1127320572
1127320609	1127320610	1127320611	1127320612	1127320613	1127320630
1127320637	1127320641	1127320642	1127320644	1127320647	1127320649
1127320669	1127321312				

**FIAT :**

60749249	60755038	60777846	9936080	9950095
----------	----------	----------	---------	---------

**FORD :**

1477517	6017534	6033077	6041730	6154904	71BB-10304BA
72GB-10304AA	74EB-10304AA	75BB-10304AA	75EB-10304AA		

**IHC :**

3078594R91

**LUCAS :**

UBB411

**MERCEDES-BENZ :**

1541316	1541416	1542016	1542916	1543216	1545016
1546416	1546816	1547616	1548116	1548216	

**OPEL :**

1205561

**SAAB :**

8518854	9955293
---------	---------

**SEAT :**

3980591	NG32033229
---------	------------

**STEYR :**

61000090743	61200090706
-------------	-------------

**VALMET :**

8353310743

## RB-01HA

Unit no.

BOSCH

0-120-400-669	0-120-400-670	0-120-400-704	0-120-400-705	0-120-400-722	0-120-400-723
0-120-400-724	0-120-400-733	0-120-400-745	0-120-400-747	0-120-400-750	0-120-400-758
0-120-400-759	0-120-400-807	0-120-400-809	0-120-400-810	0-120-400-811	0-120-400-856
0-120-400-857	0-120-400-858	0-120-400-859	0-120-400-901	0-120-400-903	0-120-400-906
0-120-400-917	0-120-488-119	0-120-488-126	0-120-489-003	0-120-489-004	0-120-489-005
0-120-489-007	0-120-489-009	0-120-489-011	0-120-489-013	0-120-489-015	0-120-489-017
0-120-489-024	0-120-489-026	0-120-489-051	0-120-489-052	0-120-489-054	0-120-489-061
0-120-489-062	0-120-489-063	0-120-489-064	0-120-489-076	0-120-489-077	0-120-489-079
0-120-489-094	0-120-489-095	0-120-489-097	0-120-489-099	0-120-489-100	0-120-489-101
0-120-489-148	0-120-489-149	0-120-489-150	0-120-489-162	0-120-489-168	0-120-489-172
0-120-489-184	0-120-489-196	0-120-489-197	0-120-489-199	0-120-489-201	0-120-489-203
0-120-489-205	0-120-489-207	0-120-489-209	0-120-489-211	0-120-489-213	0-120-489-214
0-120-489-229	0-120-489-233	0-120-489-234	0-120-489-236	0-120-489-237	0-120-489-260
0-120-489-262	0-120-489-268	0-120-489-269	0-120-489-275	0-120-489-276	0-120-489-289
0-120-489-293	0-120-489-298	0-120-489-299	0-120-489-300	0-120-489-301	0-120-489-302
0-120-489-304	0-120-489-305	0-120-489-322	0-120-489-324	0-120-489-326	0-120-489-327
0-120-489-329	0-120-489-330	0-120-489-332	0-120-489-333	0-120-489-355	0-120-489-357
0-120-489-359	0-120-489-386	0-120-489-398	0-120-489-480	0-120-489-500	0-120-489-501
0-120-489-502	0-120-489-506	0-120-489-507	0-120-489-508	0-120-489-509	0-120-489-510
0-120-489-511	0-120-489-512	0-120-489-513	0-120-489-514	0-120-489-519	0-120-489-520
0-120-489-521	0-120-489-522	0-120-489-523	0-120-489-526	0-120-489-527	0-120-489-532
0-120-489-535	0-120-489-536	0-120-489-545	0-120-489-546	0-120-489-547	0-120-489-548
0-120-489-551	0-120-489-556	0-120-489-557	0-120-489-558	0-120-489-559	0-120-489-560
0-120-489-561	0-120-489-562	0-120-489-567	0-120-489-568	0-120-489-569	0-120-489-571
0-120-489-572	0-120-489-573	0-120-489-574	0-120-489-579	0-120-489-580	0-120-489-581
0-120-489-582	0-120-489-587	0-120-489-588	0-120-489-589	0-120-489-590	0-120-489-592
0-120-489-593	0-120-489-594	0-120-489-595	0-120-489-596	0-120-489-599	0-120-489-600
0-120-489-601	0-120-489-602	0-120-489-603	0-120-489-604	0-120-489-605	0-120-489-616
0-120-489-617	0-120-489-622	0-120-489-623	0-120-489-624	0-120-489-664	0-120-489-665
0-120-489-666	0-120-489-667	0-120-489-668	0-120-489-669	0-120-489-670	0-120-489-671
0-120-489-676	0-120-489-678	0-120-489-679	0-120-489-683	0-120-489-691	0-120-489-692
0-120-489-698	0-120-489-699	0-120-489-700	0-120-489-701	0-120-489-705	0-120-489-706
0-120-489-712	0-120-489-714	0-120-489-719	0-120-489-720	0-120-489-721	0-120-489-722
0-120-489-732	0-120-489-744	0-120-489-745	0-120-489-746	0-120-489-747	0-120-489-748
0-120-489-749	0-120-489-751	0-120-489-755	0-120-489-758	0-120-489-772	0-120-489-774
0-120-489-785	0-120-489-786	0-120-489-797	0-120-489-798	0-120-489-799	0-120-489-800
0-120-489-801	0-120-489-802	0-120-489-803	0-120-489-804	0-120-489-805	0-120-489-806
0-120-489-809	0-120-489-810	0-120-489-811	0-120-489-814	0-120-489-815	0-120-489-816
0-120-489-817	0-120-489-818	0-120-489-819	0-120-489-820	0-120-489-821	0-120-489-826
0-120-489-828	0-120-489-829	0-120-489-833	0-120-489-835	0-120-489-839	0-120-489-840
0-120-489-842	0-120-489-843	0-120-489-844	0-120-489-846	0-120-489-847	0-120-489-848
0-120-489-849	0-120-489-850	0-120-489-851	0-120-489-853	0-120-489-854	0-120-489-855
0-120-489-856	0-120-489-857	0-120-489-859	0-120-489-860	0-120-489-862	0-120-489-864
0-120-489-866	0-120-489-867	0-120-489-869	0-120-489-871	0-120-489-873	0-120-489-878
0-120-489-882	0-120-489-887	0-120-489-889	0-120-489-893	0-120-489-896	0-120-489-897
0-120-489-898	0-120-489-904	0-120-489-910	0-120-489-912	0-120-489-914	0-120-489-915
0-120-489-916	0-120-489-918	0-120-489-919	0-120-489-928	0-120-489-930	0-120-489-931
0-120-489-932	0-120-489-933	0-120-489-936	0-120-489-938	0-120-489-965	0-120-489-983
0-120-489-987	0-120-489-988	0-120-489-989	0-120-489-991	0-120-489-993	0-120-489-997
9-120-144-223	9-120-144-224	9-120-144-227	9-120-144-280	9-120-144-288	9-120-690-006
9-120-690-007	9-120-690-011	9-120-690-012	9-120-690-013	9-120-690-014	9-120-690-015

**RB-02H**

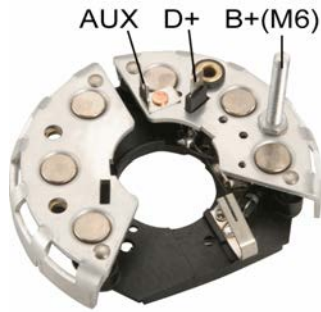

\*114mm OD  
\*6-35 Amp Diodes

**Replaces**

**ALFA ROMEO :**

116.1005.060.04    116.1005.060.08    116.1005.060.13    119.1305.061.00    119.1305.061.21

**AUDI/VW :**

046903359A    056903359B    056903371B    46903359    56903359

**BMW :**

12311266720    12311268409    12311268415    12311279597    12311356060    12311358048  
12311363097    12311706465

**BOSCH :**

1-127-011-117    1-127-011-118    1-127-011-119    1-127-011-120    1-127-011-121    1-127-011-123  
1-127-011-124    1-127-011-125    1-127-011-128    1-127-011-138    1-127-011-140    1-127-320-110  
1-127-320-117    1-127-320-128    1-127-320-139    1-127-320-148    1-127-320-149    1-127-320-150  
1-127-320-170    1-127-320-171    1-127-320-184    1-127-320-187    1-127-320-188    1-127-320-189  
1-127-320-190    1-127-320-195    1-127-320-196    1-127-320-197    1-127-320-300    1-127-320-301  
1-127-320-303    1-127-320-304    1-127-320-305    1-127-320-306    1-127-320-308    1-127-320-309  
1-127-320-313    1-127-320-318    1-127-320-320    1-127-320-325    1-127-320-326    1-127-320-336  
1-127-320-346    1-127-320-347    1-127-320-383    1-127-320-384    1-127-320-385    1-127-320-500  
1-127-320-501    1-127-320-508    1-127-320-509    1-127-320-510    1-127-320-511    1-127-320-529  
1-127-320-573    1-127-320-574    1-127-320-575    1-127-320-583    1-127-320-618    1-127-320-619  
1-127-320-620    1-127-320-622    1-127-320-623    1-127-320-624    1-127-320-633    1-127-320-634  
1-127-320-645    1-127-320-646    1-127-320-650    1-127-320-657    1-127-320-681    1-127-320-686

**CITROEN :**

9405144528

**DAF :**

692060    694461

**DELCO :**

90140931    90272286

**DELCO REMY (LUCAS) :**

21221403

**FIAT :**

60725868    60736000    60754984    79022471    79031725    79078926  
82327406    82335792    9927838    9934237    9934639    9936539  
9936608    9937233    9937529    9939571    9941113    9960115

**IHC :**

3079133R91    3079133R92

**IVECO :**

79078926

**KLOCKNER-HUMBOL-DEUTZ :**

42487948    8121110

**LANCIA :**

82302915    82302916

**MAGIRUS-DEUTZ :**

8128110    8198792

**OPEL :**

1205449    1205550    1205551    1205553    1205555    1205557  
1205558    1205559    1205562    1205565    1205569    90140010

**PEUGEOT :**

5744.52    5744.63    5744.67    5744.86    5744.88

**SAAB :**

8550113    8559825    8571903    8591083

**SAME :**

294391601

**SEAT :**

3980278    NG981025.29

**TALBOT :**

43278800

**VOLVO :**

1235288    1235577    1259577    1363914    243949    243950

**RB-02H**

692060

694461

## Unit no.

BOSCH

0-120-400-471	0-120-400-472	0-120-400-740	0-120-400-743	0-120-400-771	0-120-400-772
0-120-400-782	0-120-400-783	0-120-400-827	0-120-400-828	0-120-400-831	0-120-400-832
0-120-400-833	0-120-400-834	0-120-400-838	0-120-400-839	0-120-400-840	0-120-400-841
0-120-400-849	0-120-400-850	0-120-400-852	0-120-400-853	0-120-400-854	0-120-400-855
0-120-400-889	0-120-400-890	0-120-400-910	0-120-400-911	0-120-400-912	0-120-400-913
0-120-400-914	0-120-400-915	0-120-400-921	0-120-400-922	0-120-400-926	0-120-400-927
0-120-400-928	0-120-400-932	0-120-400-933	0-120-400-938	0-120-400-939	0-120-486-353
0-120-488-028	0-120-488-030	0-120-488-036	0-120-488-102	0-120-488-103	0-120-488-123
0-120-488-129	0-120-488-139	0-120-488-141	0-120-488-151	0-120-488-152	0-120-488-211
0-120-488-221	0-120-488-235	0-120-488-252	0-120-488-253	0-120-488-254	0-120-488-274
0-120-488-275	0-120-488-276	0-120-488-287	0-120-489-021	0-120-489-029	0-120-489-031
0-120-489-037	0-120-489-039	0-120-489-040	0-120-489-042	0-120-489-044	0-120-489-046
0-120-489-058	0-120-489-066	0-120-489-125	0-120-489-127	0-120-489-129	0-120-489-131
0-120-489-135	0-120-489-137	0-120-489-139	0-120-489-143	0-120-489-153	0-120-489-154
0-120-489-155	0-120-489-167	0-120-489-171	0-120-489-182	0-120-489-188	0-120-489-191
0-120-489-212	0-120-489-217	0-120-489-218	0-120-489-219	0-120-489-220	0-120-489-254
0-120-489-273	0-120-489-279	0-120-489-285	0-120-489-297	0-120-489-307	0-120-489-319
0-120-489-339	0-120-489-348	0-120-489-350	0-120-489-351	0-120-489-358	0-120-489-394
0-120-489-400	0-120-489-401	0-120-489-411	0-120-489-412	0-120-489-413	0-120-489-422
0-120-489-450	0-120-489-455	0-120-489-487	0-120-489-498	0-120-489-533	0-120-489-534
0-120-489-537	0-120-489-538	0-120-489-543	0-120-489-544	0-120-489-549	0-120-489-550
0-120-489-575	0-120-489-576	0-120-489-577	0-120-489-578	0-120-489-585	0-120-489-586
0-120-489-606	0-120-489-607	0-120-489-608	0-120-489-609	0-120-489-610	0-120-489-611
0-120-489-614	0-120-489-615	0-120-489-626	0-120-489-627	0-120-489-628	0-120-489-629
0-120-489-630	0-120-489-631	0-120-489-632	0-120-489-633	0-120-489-634	0-120-489-635
0-120-489-636	0-120-489-637	0-120-489-638	0-120-489-639	0-120-489-640	0-120-489-644
0-120-489-645	0-120-489-646	0-120-489-647	0-120-489-648	0-120-489-649	0-120-489-650
0-120-489-651	0-120-489-652	0-120-489-654	0-120-489-655	0-120-489-656	0-120-489-657
0-120-489-659	0-120-489-660	0-120-489-661	0-120-489-668	0-120-489-682	0-120-489-686
0-120-489-688	0-120-489-709	0-120-489-716	0-120-489-718	0-120-489-735	0-120-489-737
0-120-489-739	0-120-489-766	0-120-489-767	0-120-489-768	0-120-489-769	0-120-489-781
0-120-489-783	0-120-489-793	0-120-489-794	0-120-489-795	0-120-489-796	0-120-489-812
0-120-489-813	0-120-489-824	0-120-489-836	0-120-489-837	0-120-489-875	0-120-489-877
0-120-489-879	0-120-489-880	0-120-489-882	0-120-489-904	0-120-489-906	0-120-489-943
0-120-489-948	0-120-489-949	0-120-489-951	0-120-489-952	0-120-489-955	0-983-032-950
0-986-030-480	0-986-030-500	0-986-030-650	0-986-030-670	0-986-030-671	0-986-030-680
0-986-030-690	0-986-030-700	0-986-030-710	0-986-030-730	0-986-030-731	0-986-030-800
0-986-030-810	0-986-030-830	0-986-030-850	0-986-030-870	0-986-030-900	0-986-030-910
0-986-030-940	0-986-030-990	0-986-031-050	0-986-031-070	0-986-031-090	0-986-031-091
0-986-031-150	0-986-031-200	0-986-031-210	0-986-031-240	0-986-031-280	0-986-031-340
0-986-031-360	0-986-031-361	0-986-031-460	0-986-033-250	0-986-033-330	0-986-033-910
0-986-034-120	0-986-034-490	0-986-034-640	0-986-034-730	0-986-034-931	0-986-035-630
0-986-035-690	0-986-036-480	0-986-036-750	9-120-144-073	9-120-144-086	9-120-144-087
9-120-144-101	9-120-144-105	9-120-144-109	9-120-144-121	9-120-144-122	9-120-144-124
9-120-144-205	9-120-144-207	9-120-144-216	9-120-144-217	9-120-144-234	9-120-144-236
9-120-144-237	9-120-144-255	9-120-144-266	9-120-690-020	9-120-690-021	9-120-690-025
9-120-690-111	9-120-690-115	9-120-690-117	9-120-690-119		



**RB-03HA**

\*114mm OD  
\*6-35 Amp Diodes

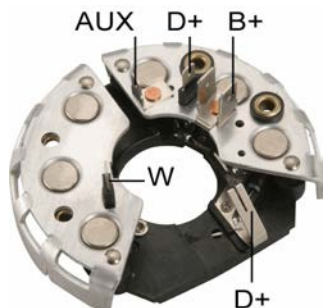

**Replaces**

**AUDI/VW :**

68903359

**BOSCH :**

1-127-011-116    1-127-320-506    1-127-320-614    1-127-320-648

**Unit no.**

BOSCH

0-120-489-080	0-120-489-081	0-120-489-082	0-120-489-083	0-120-489-186	0-120-489-209
0-120-489-210	0-120-489-211	0-120-489-248	0-120-489-249	0-120-489-250	0-120-489-282
0-120-489-283	0-120-489-470	0-120-489-960	0-120-489-961	0-120-489-966	0-120-489-967
0-120-489-968	0-120-489-969	0-120-489-971	0-120-489-972	0-120-489-973	0-120-489-974
0-120-489-975	0-120-489-976	0-120-489-977	0-120-489-978	0-120-489-979	0-120-489-980
0-120-489-981	0-986-031-470	0-986-031-480	0-986-031-481	0-986-031-501	0-986-033-340
0-986-033-350					

**RB-04H**

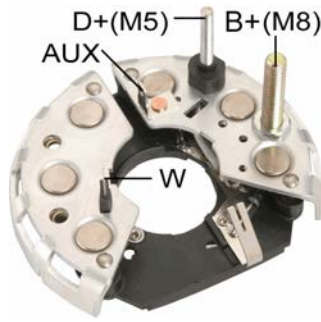

\*114mm OD  
\*6-35 Amp Diodes

**Replaces**

**AUDI/VW :**

068903539B      068903539C      069903359D

**BOSCH :**

1127320664      1127320665      1127320666      1127320661      1127320662      1127320926  
1127320945

**DELCO REMY (LUCAS) :**

21221418

**KLOCKNER-HUMBOL-DEUTZ :**

1318566

**LUCAS :**

21221418      UBB420

**MAN :**

81261090014

**VOLVO :**

9130086

**Unit no.**

**BOSCH**

0-120-488-134	0-120-488-138	0-120-488-205	0-120-488-226	0-120-488-227	0-120-488-238
0-120-488-241	0-120-488-245	0-120-488-246	0-120-488-247	0-120-488-249	0-120-488-257
0-120-488-258	0-120-488-259	0-120-488-260	0-120-488-264	0-120-488-272	0-120-488-285
0-120-489-367	0-120-489-368	0-120-489-369	0-120-489-370	0-120-489-374	0-120-489-376
0-120-489-377	0-120-489-378	0-120-489-379	0-120-489-425	0-120-489-434	0-120-489-435
0-120-489-436	0-120-489-437	0-120-489-438	0-120-489-444	0-120-489-445	0-120-489-446
0-120-489-447	0-120-489-449	0-120-489-495	0-120-489-496	0-120-489-497	0-986-032-930
0-986-034-240	0-986-034-500	0-986-034-501	0-986-034-530	0-986-034-531	0-986-034-560
0-986-034-570	0-986-034-990	0-986-038-050	0-986-038-080		

**RB-05H**

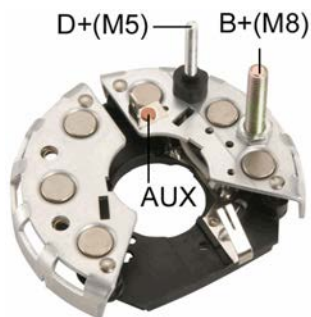

\*114mm OD  
\*6-35 Amp Diodes

**Replaces**

**AUDI/VW :**

036903359E      036903359F      036903359G      036903359H

**BOSCH :**

1-127-320-601    1-127-320-661    1-127-320-662    1-127-320-691

**SAAB :**

8598096            9555301

**VOLVO :**

9130092

**Unit no.**

**BOSCH**

0-120-469-592	0-120-469-959	0-120-488-196	0-120-488-197	0-120-488-198	0-120-488-199
0-120-488-236	0-120-488-237	0-120-488-239	0-120-488-240	0-120-488-261	0-120-488-262
0-120-488-263	0-120-488-265	0-120-488-279	0-120-489-311	0-120-489-312	0-120-489-362
0-120-489-363	0-120-489-364	0-120-489-365	0-120-489-366	0-120-489-371	0-120-489-372
0-120-489-373	0-120-489-380	0-120-489-381	0-120-489-382	0-120-489-383	0-120-489-427
0-120-489-428	0-120-489-429	0-120-489-430	0-120-489-431	0-120-489-432	0-120-489-433
0-120-489-439	0-120-489-440	0-120-489-441	0-120-489-443	0-120-489-448	0-120-489-499
0-986-034-220	0-986-034-230	0-986-034-231	0-986-034-250	0-986-034-251	0-986-034-510
0-986-034-511	0-986-034-520	0-986-034-550	0-986-034-580	0-986-035-010	0-986-036-260
0-986-036-510	9-120-080-129				

**RB-06HA**



\*114mm OD  
\*6-35 Amp Diodes

**Replaces**

**BOSCH :**

1-127-011-139    1-127-320-372    1-127-320-580    1-127-320-652    1-127-320-673

**DELCO REMY (LUCAS) :**

21221419

**FORD :**

6088149            81AB-10304DA    81DB-10304CA

**Unit no.**

**BOSCH**

0-120-488-176	0-120-488-177	0-120-488-182	0-120-488-210	0-120-489-047	0-120-489-048
0-120-489-074	0-120-489-075	0-120-489-088	0-120-489-090	0-120-489-091	0-120-489-093
0-120-489-103	0-120-489-175	0-120-489-176	0-120-489-245	0-120-489-267	0-120-489-287
0-120-489-288	0-120-489-290	0-120-489-291	0-120-489-313	0-120-489-314	0-120-489-345
0-120-489-403	0-120-489-426	0-120-489-956	0-120-489-957	0-120-489-958	0-120-489-959
0-986-030-760	0-986-030-761	0-986-030-790	0-986-033-860	0-986-033-940	0-986-034-200
0-986-036-010	0-986-036-020	0-986-036-110	9-120-144-281	9-120-144-282	9-120-144-301

**RB-07H**

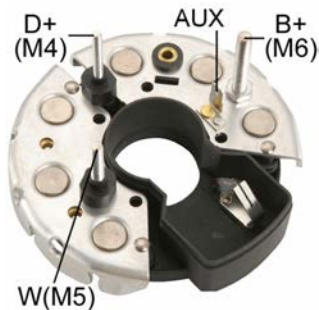

\*114mm OD  
\*6-35 Amp Diodes

**Replaces**

**BOMAG :**

5726891

**BOSCH :**

1-127-011-095	1-127-011-096	1-127-011-097	1-127-011-103	1-127-320-147	1-127-320-331
1-127-320-337	1-127-320-356	1-127-320-358	1-127-320-364	1-127-320-365	1-127-320-368
1-127-320-375	1-127-320-398	1-127-320-540	1-127-320-541	1-127-320-598	1-127-320-604

**CLAAS :**

1326530

**IHC :**

3079385R91      3079411R91

**JOHN DEERE :**

AL30419      AZ31708

**KLOCKNER-HUMBOL-DEUTZ :**

1304898	1308450	1308783	1309115	42485735	42486339
42487911					

**MAN :**

81261090001      81261090004      81261090005

**MERCEDES-BENZ :**

1542016	1542116	1542316	1543016	1543116	1544616
1545716	1546016	1546216			

**POCLAIN :**

B2140611      C2140612

**SONACOME :**

1120314      1124036

**VOLVO :**

244343      244488

**Unit no.**

**BOSCH**

0-120-469-603	0-120-469-610	0-120-486-221	0-120-488-125	0-120-488-137	0-120-488-153
0-120-488-289	0-120-488-900	0-120-489-022	0-120-489-023	0-120-489-032	0-120-489-034
0-120-489-060	0-120-489-071	0-120-489-156	0-120-489-231	0-120-489-284	0-120-489-303
0-120-489-643	0-120-489-658	0-120-489-704	0-120-489-710	0-120-489-724	0-120-489-725
0-120-489-728	0-120-489-730	0-120-489-731	0-120-489-756	0-120-489-827	0-120-489-885
0-120-489-886	0-120-489-900	0-120-489-902	0-120-489-944	0-120-489-994	0-120-489-995
0-120-489-996	0-986-031-270	0-986-031-300	0-986-031-320	0-986-031-370	0-986-031-450
0-986-033-820	0-986-035-910	0-986-038-090	9-120-080-114	9-120-080-130	9-120-080-136
9-120-080-137	9-120-080-138	9-120-080-144	9-120-080-150	9-120-080-157	9-120-080-160
9-120-080-162	9-120-080-166	9-120-144-112	9-120-144-113	9-120-144-115	9-120-144-116
9-120-144-117	9-120-144-119	9-120-144-120	9-120-144-137	9-120-334-137	

**RB-08H**



\*114mm OD  
\*6-35 Amp Diodes

**Replaces**

**BOSCH :**

1-127-011-098	1-127-011-101	1-127-320-344	1-127-320-363	1-127-320-366	1-127-320-367
1-127-320-545	1-127-320-546	1-127-320-599			

**DAF :**

694065

**FAUN :**

4791517

**FORD :**

6094903                    82DB-10304BA

**KLOCKNER-HUMBOL-DEUTZ :**

1308400                    42487053

**MAGIRUS-DEUTZ :**

8197578                    8198257

**MERCEDES-BENZ :**

1542416                    1542516                    1542716                    1545816                    1546316

**MWM :**

8011080002                    8398150001

**SAAB :**

282916

**SCANIA :**

282916                    305158

**STEYR :**

61200090706

**VOLVO :**

6239264                    94095

**Unit no.**

**BOSCH**

0-120-488-137	0-120-488-224	0-120-489-027	0-120-489-032	0-120-489-053	0-120-489-060
0-120-489-071	0-120-489-192	0-120-489-221	0-120-489-230	0-120-489-231	0-120-489-303
0-120-489-387	0-120-489-388	0-120-489-658	0-120-489-684	0-120-489-702	0-120-489-707
0-120-489-710	0-120-489-723	0-120-489-725	0-120-489-726	0-120-489-727	0-120-489-733
0-120-489-756	0-120-489-757	0-986-030-660	0-986-031-190	0-986-031-230	0-986-031-250
0-986-031-251	0-986-031-260	0-986-031-290	0-986-031-310	0-986-031-330	0-986-033-510
0-986-033-570	0-986-034-210	0-986-034-350	9-120-080-112	9-120-080-113	9-120-080-126
9-120-080-132	9-120-080-134	9-120-080-140	9-120-080-145	9-120-080-149	9-120-080-151
9-120-080-154	9-120-080-158	9-120-144-112	9-120-144-113	9-120-144-115	9-120-144-116
9-120-144-117	9-120-144-120	9-120-144-122	9-120-144-123	9-120-144-125	9-120-144-127
9-120-144-130	9-120-144-131	9-120-144-132	9-120-144-133	9-120-334-137	

**RB-101H**

\*112mm OD  
\*6-50A Avalanche Diodes

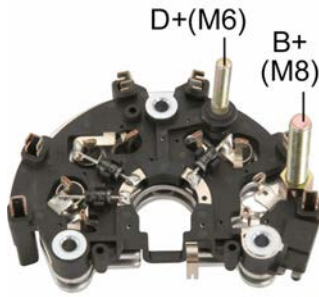

**Replaces**

**BOSCH :**

1-127-319-009    1-127-319-623    1-127-319-862

**Unit no.**

**BOSCH**

0-123-320-012    0-986-040-380

**RB-105H**

\*112mm OD  
\*6-50A Avalanche Diodes



**Replaces**

**BOSCH :**

1-127-319-570

**Unit no.**

**BOSCH**

0-120-310-023    0-120-310-048    0-123-320-050

**RB-107H**

\*122mm OD  
\*M8 Battery Post  
\*6-50A Avalanche Diodes

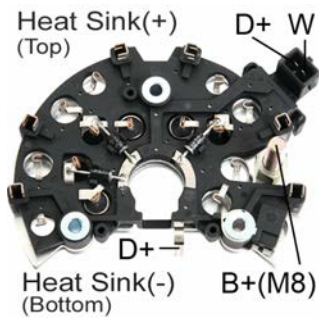

**Replaces**

**BOSCH :**

1127319572    1127319734    1127319540    1127319572    1127319733    1127319734

**Unit no.**

**BOSCH**

0-120-510-053    0-120-510-054    0-120-510-056    0-120-510-065    0-120-515-016

**RB-108H**

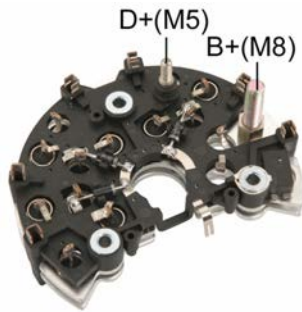

- \*122mm OD
- \*M8 Battery Post
- \*12-50A Avalanche Diodes

**Replaces**

**BOSCH :**

1-127-319-035    1-127-319-635    1-127-319-710

**Unit no.**

**BOSCH**

0-123-510-004    0-123-510-018    0-123-510-021    0-123-510-060    0-123-510-074    0-123-510-075

**RB-10H**

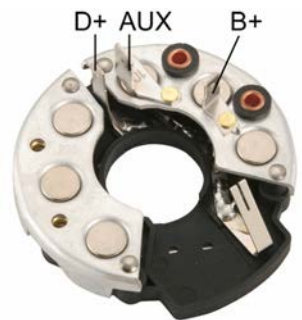

- \*90mm OD
- \*6-35 Amp Diodes

**Replaces**

**BOSCH :**

1-127-320-152    1-127-320-192    1-127-320-319

**FIAT :**

4474564    929167    9928604    9934756    9957574    9957575

**MAGNETI MARELLI :**

74986411    74995001    74995801    940038202

**SAME :**

294390902

**SEAT :**

3898152    NG981008.29

**STEYR :**

30800090739

**Unit no.**

**BOSCH**

0-120-300-568    0-120-300-569    0-120-300-592    0-120-339-515    0-120-339-516    0-120-339-523  
 0-120-339-526    0-120-339-527    0-120-339-528    0-120-339-534    0-986-030-120    0-986-030-121  
 0-986-033-077    9-120-143-017    9-120-143-204    9-120-143-218

**RB-110H**

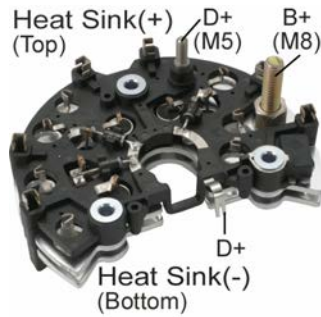

- \*122mm OD
- \*6-50A Avalanche Diodes
- \*M8 Battery Post

**Replaces**

**BOSCH :**

1-127-319-558    1-127-319-562    1-127-319-568

**Unit no.**

BOSCH

0-123-510-023    0-123-510-031&nbs0-123-510-033&nbs0-123-510-038    0-123-510-039    0-123-510-041&nbs  
 0-123-510-044    0-123-510-045&nbs0-123-510-049    0-123-510-050    0-123-510-051    0-123-510-058  
 0-123-510-059    0-123-510-061    0-123-510-066&nbs0-123-510-067    0-123-510-070&nbs0-123-510-072  
 0-123-510-080&nbs0-123-510-088&nbs0-123-510-091&nbs0-123-512-500&nbs0-123-515-003&nbs0-123-515-008&nbs  
 0-123-515-009&nbs0-123-515-011&nbs0-123-515-012&nbs0-123-515-024&nbs

**RB-112H**

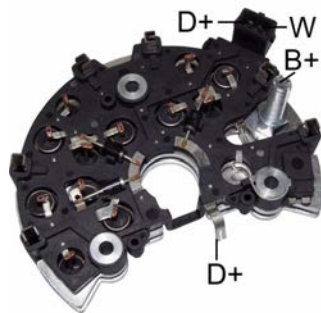

- \*122mm OD
- \*M8 Battery Post
- \*12-50A Avalanche Diodes

**Replaces**

**BOSCH :**

1-127-319-631

**Unit no.**

BOSCH

0-123-520-002    0-123-520-005

**RB-113H**

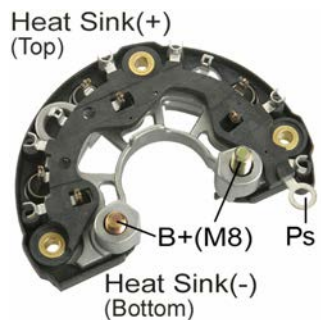

- \*120mm OD
- \*M8 Battery Post
- \*6-50 Avalanche Diodes

**Replaces**

**BOSCH :**

F-00M-123-204    F-00M-123-217

**Unit no.**

BOSCH

0-124-325-006    0-124-325-007    0-124-325-024



**RB-115H**

- \*120mm OD
- \*M8 Battery Post
- \*6-50A Avalanche Diodes

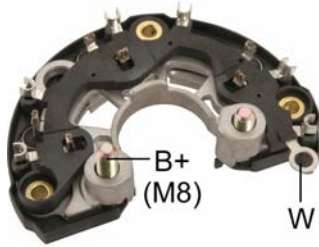

**Replaces**

**BOSCH :**

F00M123202      F00M123337

**Unit no.**

BOSCH

0-124-415-001    0-124-415-002    0-124-415-005    0-124-415-006    0-124-415-008    0-124-415-009  
0-124-415-010

**RB-116H**

- \*120mm OD
- \*M8 Battery Post
- \*6-50A Avalanche Diodes

Heat Sink(+)  
(Top)

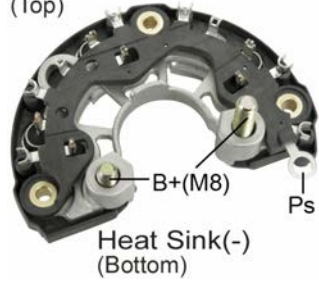

**Replaces**

**BOSCH :**

F-00M-123-201

**Unit no.**

BOSCH

0-124-225-010    0-124-315-001    0-124-315-002    0-124-315-003    0-124-315-004    0-124-315-005  
0-124-315-006    0-124-315-007    0-124-315-008    0-124-315-010    0-124-315-011    0-124-315-013  
0-124-315-014    0-124-320-001    0-124-325-001    0-124-325-002    0-124-325-003    0-124-325-004  
0-124-325-011    0-124-325-012

**RB-117H**

- \*120mm OD
- \*M8 Battery Post
- \*6-50A Avalanche Diodes

Heat Sink(+)  
(Top)

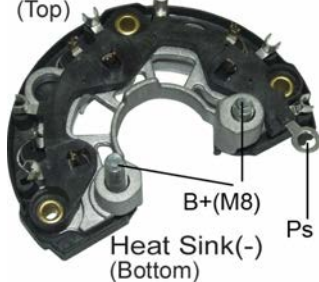

**Replaces**

**BOSCH :**

F-00M-133-224

**Unit no.**

BOSCH

0-124-555-001    0-124-555-002    0-124-555-004    0-124-555-007    0-124-555-008    0-124-555-015  
0-124-655-001    0-124-655-002    0-124-655-004  
MERCEDES-BENZ  
0121541002      0121541102

**RB-118H**

Heat Sink(+)  
(Top)

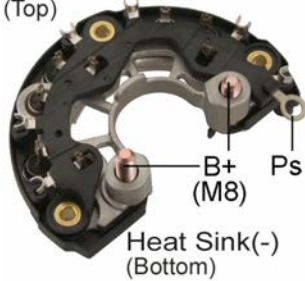

- \*120mm OD
- \*M8 Battery Post
- \*8-50A Avalanche Diodes

**Replaces**

**BOSCH :**  
F-00M-113-200

**Unit no.**

BOSCH					
0-124-225-001	0-124-225-002	0-124-225-004	0-124-225-009	0-124-225-023	0-124-225-024
0-124-225-025	0-124-225-026	0-124-225-027			

**RB-119H**

Heat Sink(+)  
(Top)

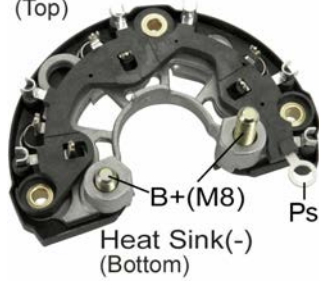

- \*120mm OD
- \*M8 Battery Post
- \*6-50A Avalanche Diodes

**Replaces**

**BOSCH :**  
F00M133201    F00M133228    F00M133244    F00M133246    F00M133351    F00M133363

**Unit no.**

BOSCH					
0-124-512-013	0-124-515-010	0-124-515-011	0-124-515-012	0-124-515-017	0-124-515-019
0-124-515-020	0-124-515-022	0-124-515-024	0-124-515-025	0-124-515-026	0-124-515-027
0-124-515-034	0-124-515-038	0-124-515-039	0-124-515-054		

**RB-11H**

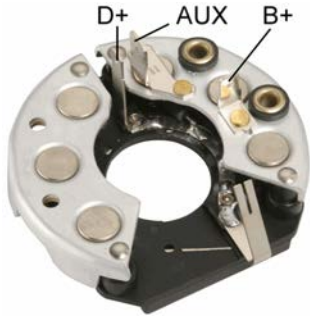

\*90mm OD  
\*6-35 Amp Diodes

**Replaces**

**ALFA ROMEO :**

208000000      700.2080.000.00      700208

**BOSCH :**

1-127-320-102      1-127-320-114      1-127-320-122      1-127-320-124      1-127-320-151      1-127-320-173  
1-127-320-327

**FIAT :**

8223891      82273891      9921409      9923275      9924967      9927730

**FORD :**

1477518      71BB-10304AA

**HANOMAG :**

582901738

**MERCEDES-BENZ :**

1541216

**Unit no.**

**BOSCH**

0-120-300-519	0-120-300-522	0-120-300-523	0-120-300-529	0-120-300-533	0-120-300-540
0-120-300-544	0-120-300-545	0-120-300-546	0-120-300-547	0-120-300-548	0-120-300-551
0-120-300-559	0-120-300-564	0-120-300-588	0-120-339-502	0-120-339-503	0-120-339-504
0-120-339-505	0-120-339-506	0-120-339-509	0-120-339-510	0-120-339-517	0-120-339-518
0-120-339-519	0-120-339-520	0-120-339-522	0-120-339-536		

**RB-121H**

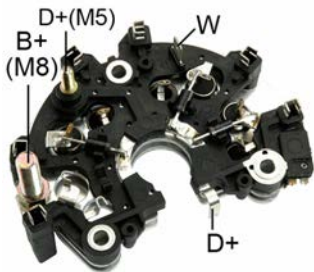

\*112mm OD  
\*M8 Battery Post  
\*6-50A Avalanche Diodes

**Replaces**

**BOSCH :**

1127320807      1127319510      1127319593      1127319729      1127319730      1127320844  
1127320864

**Unit no.**

**BOSCH**

0-120-485-011	0-120-485-012	0-120-485-022	0-123-315-005	0-123-320-029	0-123-320-044
0-123-320-045					

**RB-122H**

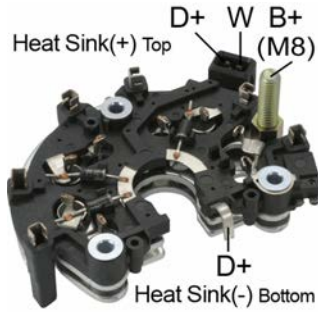

- \*112mm OD
- \*M8 Battery Post
- \*6-50A Avalanche Diodes

**Replaces**

**BOSCH :**

1-127-319-552    1-127-320-852

**Unit no.**

**BOSCH**

0-120-485-034	0-120-485-043	0-120-485-044	0-123-310-002	0-123-310-003	0-123-310-024
0-123-310-025	0-123-310-032	0-123-315-002	0-123-320-017	0-123-320-019	

**RB-123H**

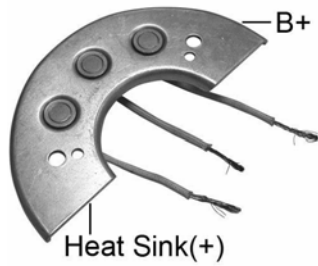

- \*3-35 Amp Diodes

**Replaces**

**BOSCH :**

1-125-715-064    1-125-715-065    9-121-080-244    9-121-080-349    9-121-080-671    9-121-080-849

**Unit no.**

**BOSCH**

9-120-080-020	9-120-080-031	9-120-080-054	9-120-080-082	9-120-080-084	9-120-080-091
9-120-080-110	9-120-080-125				

**RB-124H**

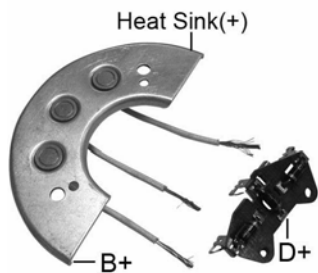

- \*w/Diode Trios
- \*3-35 Amp Diodes

**Replaces**

**BOSCH :**

1-125-715-064    1-125-715-065    9-121-080-244    9-121-080-349    9-121-080-671    9-121-080-849

**Unit no.**

**BOSCH**

9-120-080-020	9-120-080-031	9-120-080-054	9-120-080-082	9-120-080-084	9-120-080-091
9-120-080-110	9-120-080-125				

**RB-125H**

\*3-35 Amp Diodes



**Replaces**

**BOSCH :**

9-121-450-310    9-121-450-311    9-121-450-533

**Unit no.**

**BOSCH**

9-190-450-042    9-190-450-044    9-190-450-052    9-190-450-071    9-190-450-100    9-190-450-101  
 9-190-450-102    9-190-450-113    9-190-450-118    9-190-450-119

**RB-128H**

\*3-35 Amp Diodes



**Replaces**

**BOSCH :**

9-121-450-310    9-121-450-311    9-121-450-533

**Unit no.**

**BOSCH**

9-120-450-042    9-120-450-044    9-120-450-052    9-120-450-053    9-120-450-058    9-120-450-071  
 9-120-450-085    9-120-450-090    9-120-450-092    9-120-450-093    9-120-450-100    9-120-450-102  
 9-120-450-113    9-120-450-130    9-120-450-132

**RB-12H**

\*90mm OD

\*6-35 Amp Diodes

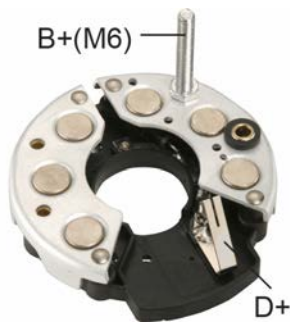

**Replaces**

**ALFA ROMEO :**

116.0005.061.00    116.0005.061.21

**BOSCH :**

1-127-320-118    1-127-320-121    1-127-320-342

**OPEL :**

1205552

**Unit no.**

**BOSCH**

0-120-300-531    0-120-300-537    0-120-300-539

**RB-130H**

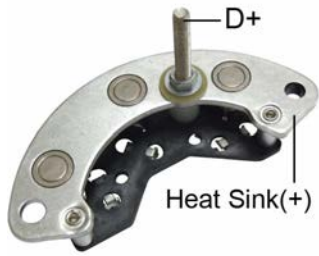

- \*w/Diode Trios
- \*M5 Battery Post
- \*3-35 Amp Diodes

**Replaces**

**BOSCH :**  
9-121-080-374

**Unit no.**

BOSCH  
 9-120-080-045    9-120-080-049    9-120-080-057    9-120-080-085    9-120-080-094    9-120-080-107  
 9-120-080-138    9-120-080-146

**RB-131H**

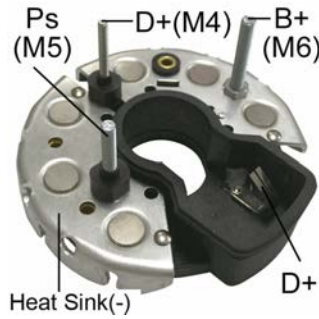

- \*6-35 Amp Diodes
- \*M6 Battery Post

**Replaces**

**BOSCH :**  
9-122-080-509

**Unit no.**

BOSCH  
 9-120-080-181    9-120-080-183    9-120-080-219

**RB-132H**

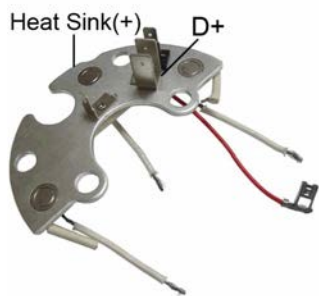

- \*w/Diode Trios
- \*3-35 Amp Diodes

**Replaces**

**BOSCH :**  
9-121-450-587

**Unit no.**

BOSCH  
 9-120-450-110

**RB-134H**

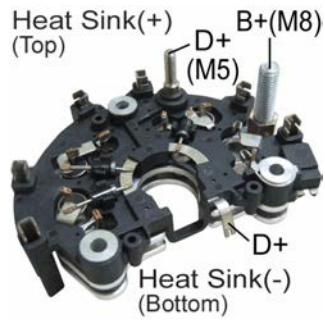

\*M5 Battery Post  
\*6-50A Avalanche Diode

**Replaces**

**BOSCH :**

1-127-319-011    1-127-319-560    1-127-319-749

**Unit no.**

BOSCH

0-123-310-042    0-123-315-020    0-123-315-500    0-123-320-030

**RB-135H**

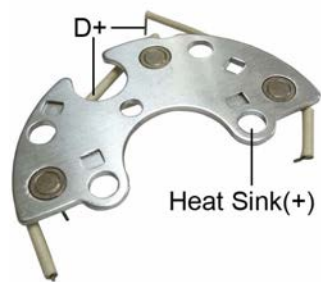

\*w/Diode Trios  
\*3-35 Amp Diodes

**Replaces**

**BOSCH :**

9-121-450-574

**Unit no.**

BOSCH

9-120-450-014    9-120-450-073    9-120-450-129    9-120-450-133    9-120-450-134    9-120-450-137

**RB-137H**

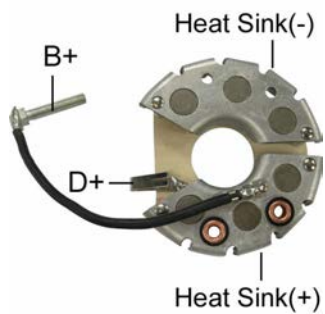

\*M6 Battery Post  
\*6-35A Amp Diodes

**Replaces**

**BOSCH :**

9-121-080-595

**Unit no.**

BOSCH

9-120-080-041    9-120-080-061    9-120-080-072    9-120-080-090

**RB-137HV**

Same as RB-137H but W/6-50 Amp Diodes  
 \*M6 Battery Post

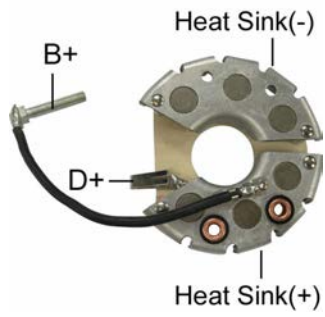

**Replaces**

**BOSCH :**  
 9-121-080-595

**Unit no.**

**BOSCH**  
 9-120-080-041    9-120-080-061    9-120-080-072    9-120-080-090

**RB-138H**

\*M5 Battery Post  
 \*6-35 Amp Diodes

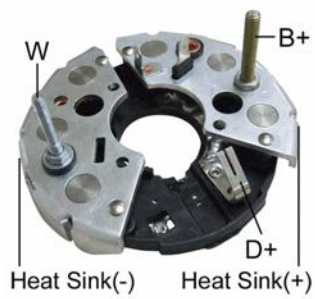

**Replaces**

**BOSCH :**  
 9-122-080-638

**Unit no.**

**BOSCH**  
 9-120-080-197



**RB-13H**



- \*90mm OD
- \*M6 Battery Post
- \*6-35 Amp Diodes

**Replaces**

**BOMAG :**

5726892

**BOSCH :**

1-127-320-115	1-127-320-116	1-127-320-141	1-127-320-142	1-127-320-146	1-127-320-316
1-127-320-317	1-127-320-569	1-227-320-116	1-237-320-345		

**IHC :**

3078957R91      3078957R92

**JOHN DEERE :**

AL27374      AZ24486

**KLOCKNER-HUMBOL-DEUTZ :**

1306533      9941262

**LAMBORGHINI :**

294390706      294391002

**MWM :**

8011080001	8339940004	833994001	8398150001	839815001
------------	------------	-----------	------------	-----------

**Unit no.**

**BOSCH**

0-120-300-535	0-120-300-552	0-120-300-562	0-120-300-567	0-120-300-575	0-120-300-576
0-120-300-577	0-120-300-578	0-120-300-579	0-120-300-580	0-120-300-584	0-120-300-585
0-120-300-586	0-120-300-589	0-120-300-590	0-120-339-511	0-120-339-512	0-120-339-513
0-120-339-514	0-120-339-521	0-120-339-531	0-120-339-532	0-120-339-535	0-120-339-536
0-120-339-537	0-120-339-538	0-120-339-542	0-120-339-544	0-120-339-545	0-120-339-584
0-120-400-836	0-120-400-837	0-986-030-110	0-986-030-130	0-986-030-140	0-986-031-120
9-120-143-003	9-120-143-021	9-120-143-025	9-120-143-026	9-120-143-201	9-120-143-202
9-120-143-222	9-120-143-223	9-120-143-228			

**RB-141H**



- \*M8 Battery Post
- \*8-50 Amp Diodes

**Replaces**

**BOSCH :**

9-128-041-566

**RB-145H**

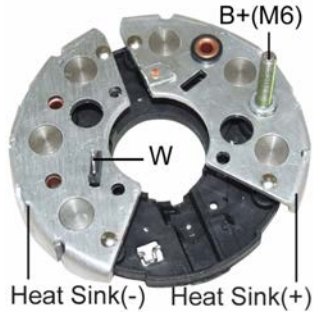

\*M6 Battery Post  
\*6-35 Amp Diodes

**Replaces**

**BOSCH :**  
9-122-080-923

**Unit no.**

BOSCH  
9-120-080-215    9-120-080-222    9-120-080-231

**RB-146H**

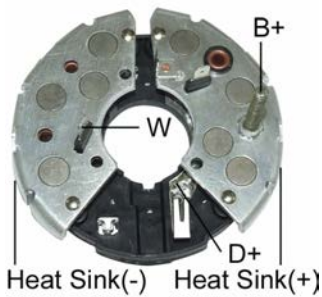

\*M6 Battery Post  
\*8-35A Avalanche Diode

**Replaces**

**BOSCH :**  
F-000-LD1-006

**Unit no.**

BOSCH  
9-120-080-226    9-120-080-232    F-000-LD0-100    F-000-LD0-102

**RB-148H**

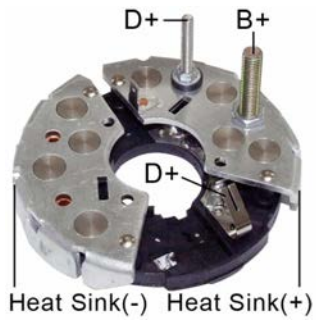

\*M8 Battery Post  
\*8-35 Amp Diodes

**Replaces**

**BOSCH :**  
9-122-080-676

**Unit no.**

BOSCH  
9-120-080-167

**RB-14H**

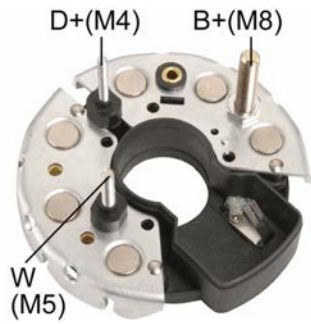

- \*114mm OD
- \*M8 Battery Post
- \*6-35 Amp Diodes

**Replaces**

**BOSCH :**  
 1-127-320-909    9-127-041-132    9-127-041-133    1-127-320-910  
**MERCEDES-BENZ :**  
 1547016

**Unit no.**

BOSCH  
 0-120-489-316

**RB-158H**

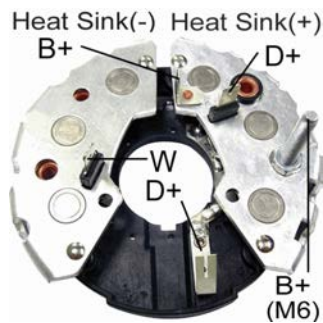

- \*115mm OD
- \*M6 Battery Post
- \*6-35 Amp Diodes

**Replaces**

**BOSCH :**  
 F-000-LD1-012

**Unit no.**

BOSCH  
 9-120-080-212    9-120-080-230

**RB-159H**



- \*115mm OD
- \*3-35 Amp Diodes

**Unit no.**

BOSCH  
 9-120-450-006    9-120-450-124  
 FORD  
 87HLL-10300DA    E5HT-10300EA

**RB-15H**



- \*114mm OD
- \*M6 Battery Post
- \*6-35 Amp Diodes

**Replaces**

**BOSCH :**  
1-127-320-668

**Unit no.**

BOSCH  
0-120-488-125    0-120-489-156    0-120-489-643    0-120-489-703    0-120-489-704    0-986-033-320  
9-120-144-119

**RB-160H**

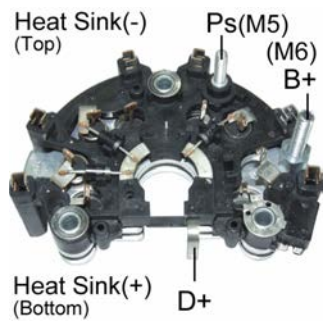

- \*112mm OD
- \*M6 Battery Post
- \*6-50A Avalanche Diodes

**Replaces**

**BOSCH :**  
1-127-319-584

**Unit no.**

BOSCH  
0-120-485-029    0-123-310-014    0-123-310-015    0-123-310-029    0-123-310-053    0-123-320-014  
0-986-036-690    0-986-038-660

**Used On**

**FORD**

Escort	1992-2000
Fiesta	1992-2000
Escort 1.6L 16V	1995-2000

**RB-161H**

Heat Sink(+)  
(Top)

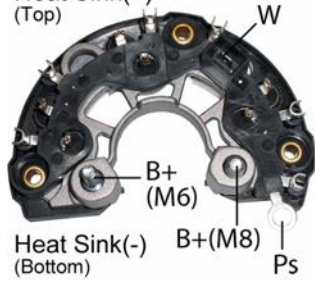

- \*120mm OD
- \*M6 Battery Post
- \*6-50 Avalanche Diodes

Unit no.

BOSCH  
0-124-325-064  
FORD  
1C35-10300AA    1C35-10300AB

Used On

**FORD**

Truck 3.9L 1998-2006

**RB-163H**

Heat Sink(+)  
(Top)

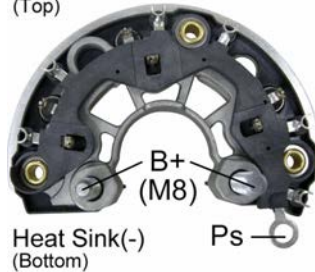

- \*130mm OD
- \*M8 Battery Post
- \*6-50A Avalanche Diodes

Replaces

**BOSCH :**  
F-00M-133-206    F-00M-133-230    F-00M-133-248

Unit no.

BOSCH  
0-124-515-028    0-124-515-040

**RB-166H**

Heat Sink(+)  
(Top)

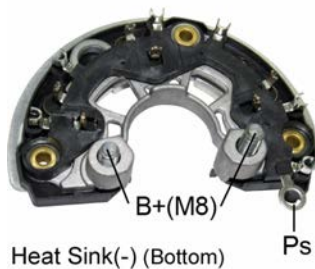

- \*130mm OD
- \*M8 Battery Post
- \*6-70A Avalanche Diodes

Replaces

**BOSCH :**  
F00M133276    F00M133249    F00M133204    F00M133214    F00M133215    F00M133218  
F00M133229    F00M133247

Unit no.

BOSCH  
0-124-625-001    0-124-625-003    0-124-625-005    0-124-625-006    0-124-625-007    0-124-625-010  
0-124-625-020    0-124-625-022    0-124-625-024    0-124-625-025    0-124-625-026    0-124-625-028

**RB-167HV**

Heat Sink(+)(Top)

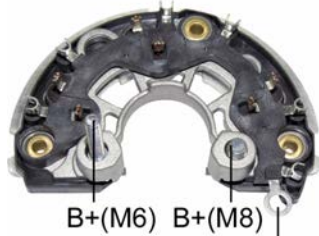

Heat Sink(-)(Bottom) Ps

- \*130mm OD
- \*M8 Battery Post
- \*6-50A Avalanche Diodes
- \*□ connection

**Replaces**

**BOSCH :**

F-00M-123-265

Unit no.

BOSCH

0-124-325-121    0-124-325-153

GENERAL MOTORS

15200267    15222342

**RB-168H**

Heat Sink(+)(Top)

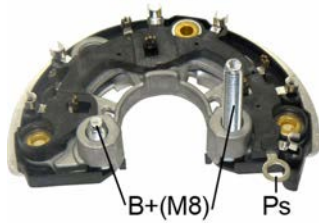

Heat Sink(-)(Bottom)

- \*130mm OD
- \*M8 Battery Post
- \*6-50A Avalanche Diodes

**Replaces**

**BOSCH :**

F00M133226    F00M133369    F00M133372

Unit no.

BMW

12317501595    12317501597    12317501599    12317501690

BOSCH

0-124-515-050    0-124-515-097

**RB-16H**

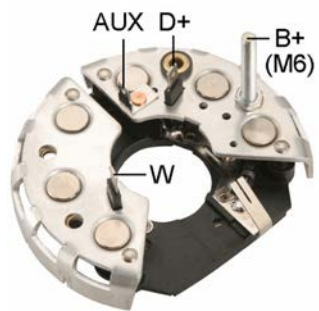

- \*114mm OD
- \*M6 Battery Post
- \*6-35 Amp Diodes

**Replaces**

**BOSCH :**

1-127-011-131

Unit no.

BOSCH

0-120-489-069    0-120-489-070    0-120-489-183    0-120-489-286    0-120-489-294    0-120-489-296

0-120-489-475    0-120-489-481

**RB-170HD**

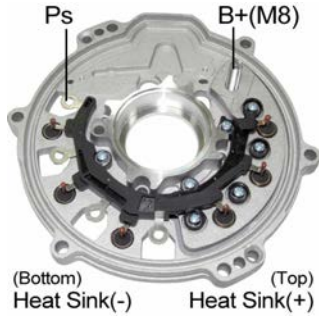

\*M8 Battery Post  
\*6-70A Avalanche Diodes

**Replaces**

**BOSCH :**  
F-00M-256-202

**Unit no.**

BOSCH  
0-122-468-015

**RB-171HV**

Heat Sink(+)(Top)

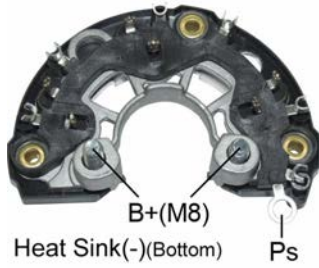

\*120mm OD  
\*6-50 Amp Diodes

**Replaces**

**BOSCH :**  
F-00M-133-202

**Unit no.**

BOSCH  
0-124-525-002    0-124-525-003    0-124-525-006    0-124-525-007    6-004-ML0-000    6-004-ML0-001  
6-004-ML0-005  
CHRYSLER  
56041120AC    56041322    56041322AB

**Used On**

**DODGE**

Dakota Pickup 4.7L    2000 -  
Durango 4.7L    2000 -

**JEEP**

Grand Cherokee 4.0L    1999-2000  
Grand Cherokee 4.7L    1999-2000

**RB-172H**

Heat Sink(+)  
(Top)

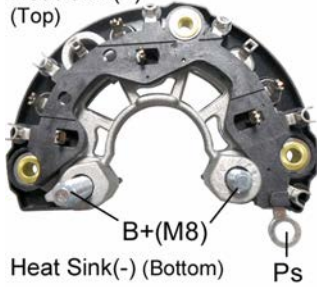

- \*120mm OD
- \*M8 Battery Post
- \*6-50A Avalanche Diodes

**Replaces**

**BOSCH :**

F-00M-123-249    F-00M-123-228

**Unit no.**

BOSCH

0-124-325-066    0-124-325-076

**RB-174HD**

Heat Sink(-)    Heat Sink(+)  
(Bottom)        (Top)

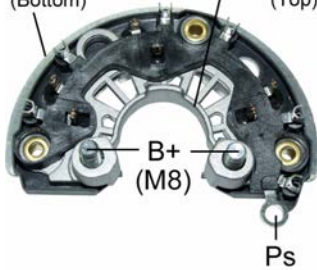

- \*130mm OD
- \*M8 Battery Post
- \*6-70A Avalanche Diodes

**Replaces**

**BOSCH :**

F-00M-133-267    F-00M-133-311

**Unit no.**

BMW

12317532965    12317532966    12317532969    12317533270

BOSCH

0-124-525-063    0-124-525-059

**Used On**

**BMW**

116

2004-

118

2004-

120

2004-

Z4 Series

2004-

316 1.6L

2001-2005

318 1.6L

2001-2005



**RB-175HD**

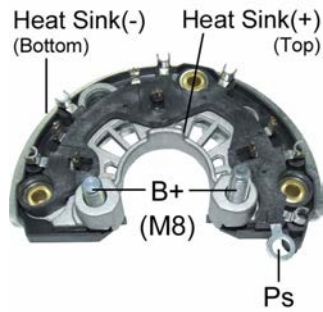

- \*130mm OD
- \*M8 Battery Post
- \*6-70A Avalanche Diodes

**Replaces**

**BOSCH :**

F-00M-133-265    F-00M-133-278    F-00M-133-312    F-00M-133-313

**Unit no.**

BOSCH  
0-124-525-026

**Used On**

**BMW**

325 Series 2.5L	2004-
525i 2.5L	2004-
X3 2.5L	2004-
Z4 3.0L	2003-
Z4 2.5L	2003-

**RB-178H**

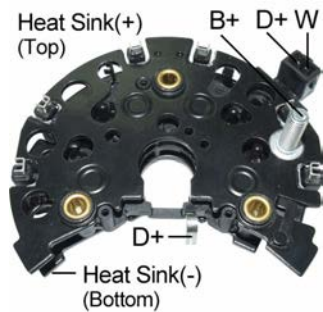

- \*122mm OD
- \*8-35 Amp Diodes

**Replaces**

**BOSCH :**

1127319738    1127320854    1127319737    1127319576

**VOLKSWAGEN :**

028-903-359G

**Unit no.**

BOSCH  
0-986-038-950    0-986-039-030    0-986-040-940    0-120-465-019    0-120-465-021

**Used On**

**VOLKSWAGEN**

Corrado 2.8L	1992-
Corrado V6 ABV	1992-1995
Vento 2800 V6	1992-1995

**RB-179HV**

Heat Sink(+)  
(Top)

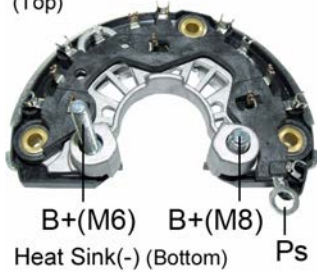

- \*130mm OD
- \*M8 Battery Post
- \*6-50A Avalanche Diodes
- \*Y connection

**Replaces**

**BOSCH :**  
F-00M-123-266

**Unit no.**

BOSCH  
0-124-325-133  
GM  
15124532

**RB-17H**



- \*114mm OD
- \*M8 Battery Post
- \*6-35 Amp Diodes

**Replaces**

**BOSCH :**  
9-121-147-302

**OPEL :**  
1205568                      90010012

**Unit no.**

BOSCH					
0-120-488-000	0-120-488-001	0-120-488-002	0-120-488-003	0-120-488-004	0-120-488-005
0-120-488-007	0-120-488-008	0-120-488-009	0-120-488-010	0-120-488-011	0-120-488-012
0-986-034-450	9-120-144-292	9-120-144-305	9-120-144-605	9-120-144-606	9-120-144-608
9-120-144-609	9-120-144-610	9-120-144-611	9-120-144-612	9-120-144-613	9-120-144-614
9-120-144-617	9-120-144-618	9-120-144-621	9-120-144-622	9-120-144-626	9-120-144-635
9-120-334-626	9-120-334-628	9-120-334-635	9-120-344-628		

**RB-180HV**

Heat Sink(+)  
(Top)

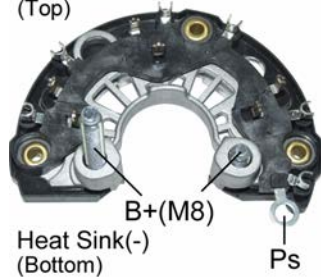

- \*120mm OD
- \*M8 Battery Post
- \*6-50 Amp Diodes

**Replaces**

**BOSCH :**  
F-00M-133-225

**Unit no.**

BOSCH				
0-124-425-001	0-124-525-004	0-124-525-005	0-124-525-041	0-124-525-105
CHRYSLER				
4801475AA	AB; 56028238AB	56028239AB	56028732AA	

**Used On**

**DODGE**

Ram 1500 3.9L	1999-2000
Ram 1500 5.2L	1999-2000
Ram 1500 5.9L	1999-2000
Ram 2500 8.0L	1999-2000
3500 8.0L	1999-2000
Ram 4000 5.9L	1999-2000

**RB-181HD**

Heat Sink(+)  
(Top)

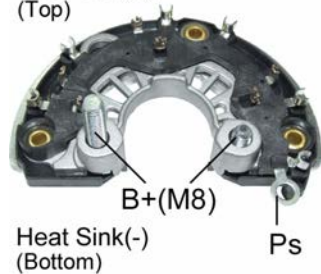

- \*M8 Battery Post
- \*6-70A Avalanche Diodes

**Replaces**

**BOSCH :**  
F-00M-133-274    F-00M-133-292

**Unit no.**

BOSCH	
0-124-525-054	0-124-525-055

**RB-184HV**

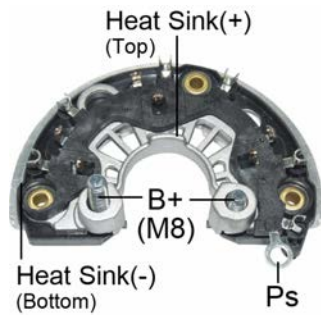

- \*130mm OD
- \*M8 Battery Post
- \*6-50A Avalanche Diodes

Unit no.   
 BOSCH  
 0-124-615-029

**RB-185HV**

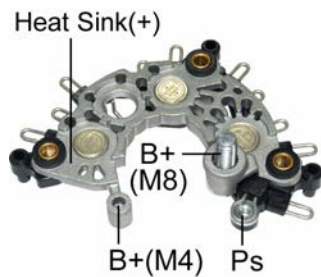

- \*117mm OD
- \*M8 Battery Post
- \*3-50A Avalanche Diodes
- \*Positive Rectifier

Unit no.   
 BOSCH  
 F-000-BL0-424 F-000-BL0-618

**Used On**

**VOLKSWAGEN**

Polo 1.4 Non-Turbo Gas	CDD	2011-
Polo 1.4 Non-Turbo Gas	CLP	2011-
Polo 1.4 Non-Turbo Gas	CLP	2013-
Polo 1.4 Turbo Gas	CFB	2012-
Polo 1.6 Non-Turbo Gas	CDE	2009-
Polo 1.6 Non-Turbo Gas	CLS	2011-

**RB-188H**

- \*6-35A Avalanche Diodes

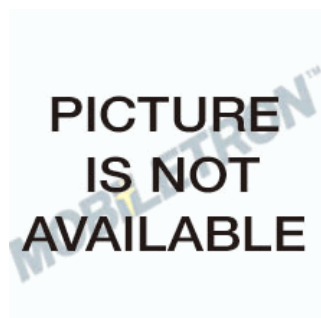

Unit no.   
 BOSCH  
 0-124-325-116

**RB-189H**

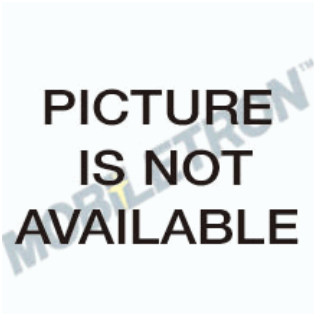

Unit no.   
 BOSCH   
 F-000-BL0-740 F-000-BL0-743

**RB-18H**

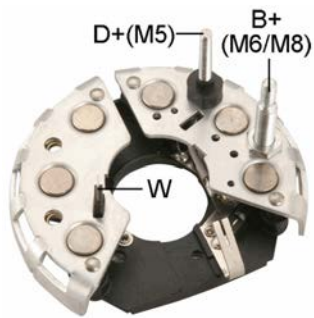

- \*114mm OD
- \*M6/M8 Battery Post
- \*6-35 Amp Diodes

**Replaces**   
 **BOSCH :**   
 1127320914   
 **GM :**   
 90350009   
 **OPEL :**   
 1205572

Unit no.   
 BOSCH   
 0-120-488-186 0-120-488-187

**RB-19H**

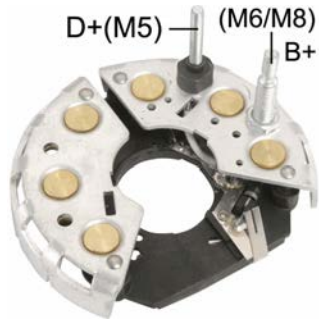

- \*114mm OD
- \*M6/M8 Battery Post
- \*6-35 Amp Diodes

**Replaces**

**BOSCH :**

1-127-320-651      1-127-320-677

**GM :**

90349909

**OPEL :**

1205571              1205573              90017587

**Unit no.**

**BOSCH**

0-120-488-156	0-120-488-157	0-120-488-158	0-120-488-159	0-120-488-160	0-120-488-161
0-120-488-162	0-120-488-163	0-120-488-164	0-120-488-165	0-120-488-166	0-120-488-167
0-120-488-168	0-120-488-169	0-120-488-170	0-120-488-171	0-120-488-172	0-120-488-173
0-120-488-174	0-120-488-175	0-120-488-190	0-120-488-191	0-120-488-192	0-120-488-193
0-120-488-200	0-120-488-201	0-120-488-202	0-120-488-203	0-120-488-204	0-120-488-255
0-120-488-281	0-986-030-840	0-986-030-880	0-986-030-920	0-986-030-930	0-986-034-650
0-986-034-651	0-986-034-660	0-986-034-930	0-986-036-530	0-986-036-540	

**RB-24H**

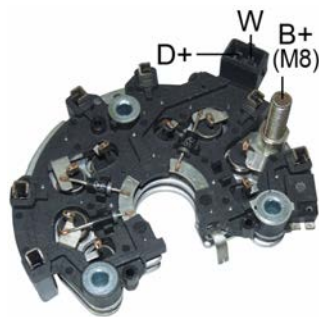

- \*112mm OD
- \*M8 Battery Post
- \*8-50A Avalanche Diodes

**Replaces**

**BOSCH :**

1-127-319-667      1-127-320-850

**Unit no.**

**BOSCH**

0-120-485-036	0-120-485-038	0-120-485-039	0-123-320-001	0-123-320-002	0-123-320-005
0-123-340-002	0-123-340-003	0-123-340-005			

**RB-26H**

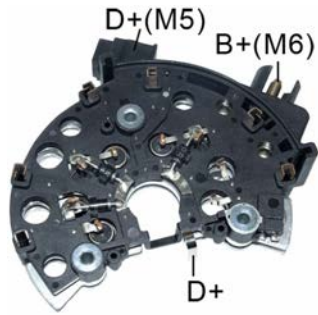

- \*122mm OD
- \*M6 Battery Post
- \*6-50A Avalanche Diodes

**Replaces**

**BOSCH :**

1-127-319-033    1-127-319-580    1-127-319-715

Unit no.

BOSCH

0-123-212-001

**RB-28H**

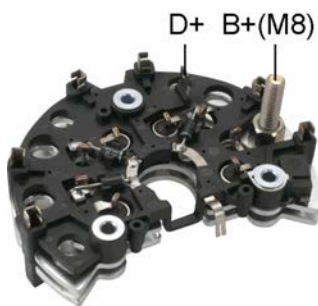

- \*122mm OD
- \*M8 Battery Post
- \*8-50A Avalanche Diodes

**Replaces**

**BOSCH :**

1-127-319-512    1-127-320-818

Unit no.

BOSCH

0-120-465-018    0-120-465-029

**RB-29H**

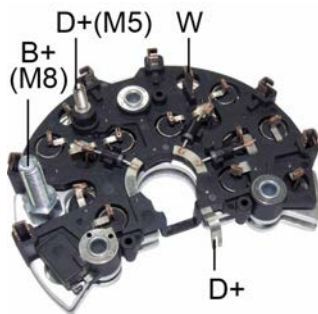

- \*122mm OD
- \*M8 Battery Post
- \*14-50A Avalanche Diodes

**Replaces**

**BOSCH :**

1-127-319-031    1-127-319-637

Unit no.

BOSCH

0-120-465-003    0-120-465-004    0-120-465-013    0-120-465-014

**RB-30H**



- \*112mm OD
- \*M8 Battery Post
- \*8-50A Avalanche Diodes

**Replaces**

**BOSCH :**  
1-127-319-019

**Unit no.**

BOSCH  
0-123-320-003    0-123-340-001    0-124-485-020    0-124-485-023

**RB-32H**

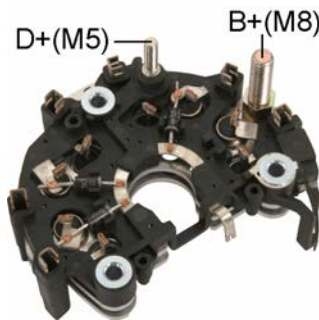

- \*106mm OD
- \*M8 Battery Post
- \*8-50A Avalanche Diodes

**Replaces**

**BOSCH :**  
1-127-319-005    1-127-319-601    1-127-319-766

**Unit no.**

BOSCH  
0-123-110-005    0-123-120-001

**RB-33H**



- \*122mm OD
- \*M8 Battery Post
- \*6-50A Avalanche Diodes

**Replaces**

**BOSCH :**  
1127319013    1127319597    1127319778    1127319743    1127319744    1127319665

**Unit no.**

BOSCH  
0-123-505-001    0-123-505-004    0-123-510-003    0-123-510-020    0-123-510-052



**RB-36H**



- \*112mm OD
- \*M8 Battery Post
- \*6-50A Avalanche Diodes

**Replaces**

**BOSCH :**

1-127-319-522    1-127-319-607    1-127-319-694

**Unit no.**

**BOSCH**

0-123-310-010    0-123-310-011    0-123-310-012    0-123-310-013    0-123-320-017

**RB-37H**



- \*112mm OD
- \*M8 Battery Post
- \*6-50A Avalanche Diodes

**Replaces**

**BOSCH :**

1-127-319-530    1-127-319-599    1-127-319-726

**Unit no.**

**BOSCH**

0-123-100-001    0-123-100-002

**RB-38H**

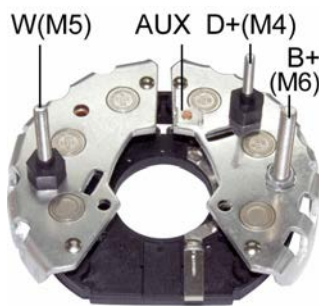

- \*114mm OD
- \*M6 Battery Post
- \*6-35 Amp Diodes

**Replaces**

**BOSCH :**

1127320667    1127319113

**FORD :**

6156187    86AB10304AA

**GM :**

90350013

**LUCAS :**

2131030    UBB429

**MAGNETI MARELLI :**

940038210

**Unit no.**

**BOSCH**

0-120-488-228    0-120-488-286    0-120-489-346    0-120-489-347    0-120-489-389    0-120-489-392  
 0-120-489-408    0-986-034-470

**RB-40H**

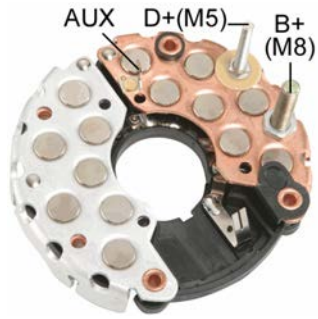

- \*120mm OD
- \*M8 Battery Post
- \*14-35 Amp Diodes

**Replaces**

**BOSCH :**

1-127-320-584    1-127-320-608

**Unit no.**

BOSCH

0-120-469-623    0-127-469-624

**RB-41H**



- \*120mm OD
- \*12-35 Amp Diodes

**Replaces**

**BOSCH :**

1-127-011-157    1-127-320-565

**Unit no.**

BOSCH

0-120-469-586    0-120-469-588    0-120-469-589    0-120-469-590

**RB-42H**



- \*120mm OD
- \*12-35 Amp Diodes

**Replaces**

**BOSCH :**

1-127-320-369

**FORD :**

78GB-10304AA

**MERCEDES-BENZ :**

1543516

**Unit no.**

BOSCH

0-120-469-516    0-120-469-517    0-120-469-530    0-120-469-531    0-120-469-570    0-120-469-571  
 0-120-469-573    0-120-469-574    0-120-469-594    0-120-469-595    0-986-030-560    0-986-030-561

**RB-43H**



\*120mm OD  
\*12-35 Amp Diodes

**Replaces**

**AUDI/VW :**

053903359C

**BOSCH :**

1-127-320-360 1-127-320-538

**LUCAS :**

21221435

**MERCEDES-BENZ :**

1544116

**Unit no.**

BOSCH

0-120-469-515 0-120-469-534 0-120-469-535 0-120-469-555 0-120-469-556 0-120-469-558

0-120-469-583 0-120-469-584 0-120-469-721 0-986-030-510 0-986-033-110 0-986-033-140

**RB-44H**

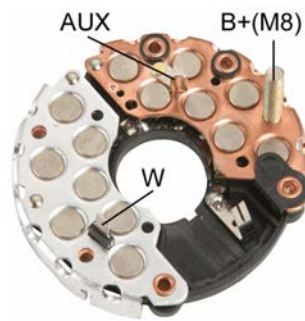

\*120mm OD  
\*14-35 Amp Diodes

**Replaces**

**BOSCH :**

1-127-320-516

**Unit no.**

BOSCH

0-120-469-545 0-120-469-546 0-120-469-547 0-120-469-548 0-120-469-607

**RB-46H**

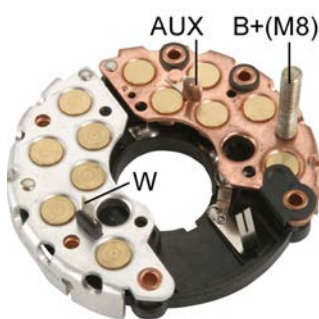

\*120mm OD  
\*12-35 Amp Diodes

**Replaces**

**AUDI/VW :**

069903359A

**BOSCH :**

1-127-320-515

**Unit no.**

BOSCH

0-120-469-541 0-120-469-542 0-120-469-543 0-120-469-544 0-120-469-598 0-120-469-599

**RB-47H**



\*120mm OD  
\*14-35 Amp Diodes

**Replaces**

**BOSCH :**  
1-127-320-370

**Unit no.**

BOSCH					
0-120-450-008	0-120-450-009	0-120-469-564	0-120-469-567	0-120-469-568	0-120-469-628
0-120-469-664	0-120-469-668	0-120-469-670	0-120-469-680	0-120-469-681	0-986-032-990
0-986-033-010	0-986-034-380				

**RB-48H**

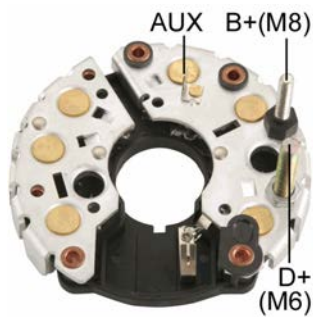

\*120mm OD  
\*6-35 Amp Diodes

**Replaces**

**BOSCH :**  
1-127-320-721

**Unit no.**

BOSCH					
0-120-469-828	0-120-469-829	0-120-469-830	0-120-469-918	0-120-469-919	0-986-036-770

**RB-49H**



\*120mm OD  
\*6-35 Amp Diodes

**Replaces**

**BOSCH :**  
1127320717    1127320726    1127320734    1127320740    1127320935

**Unit no.**

BOSCH					
0-120-468-042	0-120-468-043	0-120-468-061	0-120-468-062	0-120-468-063	0-120-468-064
0-120-468-075	0-120-468-076	0-120-468-077	0-120-468-078	0-120-468-102	0-120-468-103
0-120-468-104	0-120-468-105	0-120-468-110	0-120-469-967	0-120-469-968	0-120-469-969
0-120-469-973	0-120-469-974	0-120-469-984	0-120-469-985	0-123-510-017	0-986-035-740
0-986-035-750	0-986-036-760	0-986-038-310	0-986-038-330	0-986-038-750	

**RB-50H**

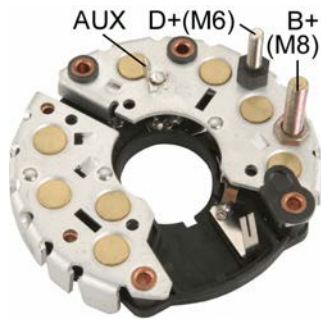

\*120mm OD  
\*8-35 Amp Diodes

**Replaces**

**BOSCH :**  
1-127-320-727

**Unit no.**

BOSCH  
0-120-469-878    0-120-469-879    0-120-469-913    0-120-469-914

**RB-51H**



\*120mm OD  
\*8-35 Amp Diodes

**Replaces**

**BOSCH :**  
1-127-320-700    1-127-320-730

**FIAT :**  
9941712    9942883    9950118    9950193

**FORD :**  
1632835    E5RD10304AA

**Unit no.**

BOSCH  
0-120-469-028    0-120-469-029    0-120-469-034    0-120-469-035    0-120-469-631    0-120-469-632  
0-120-469-633    0-120-469-635    0-120-469-636    0-120-469-671    0-120-469-672    0-120-469-696  
0-120-469-697    0-120-469-698    0-120-469-699    0-120-469-700    0-120-469-708    0-120-469-712  
0-120-469-715    0-120-469-716    0-120-469-720    0-120-469-847    0-120-469-848    0-120-469-858  
0-120-469-859    0-120-469-860    0-120-469-861    0-120-469-875    0-120-469-892    0-120-469-893  
0-120-469-937    0-120-469-939    0-120-469-940    0-120-469-979    0-120-469-980    0-120-469-981  
0-986-032-730    0-986-033-160    0-986-034-130    0-986-034-150    0-986-034-160    0-986-035-700  
0-986-035-710    0-986-035-720    0-986-036-780

**RB-52H**

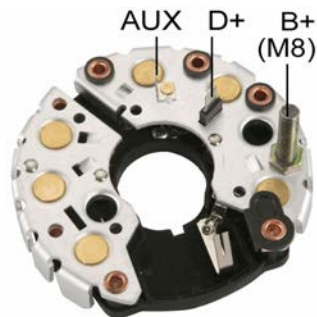

\*120mm OD  
\*6-35 Amp Diodes

**Replaces**

**BOSCH :**

1-127-320-704

**FIAT :**

9939575                      9950067

**Unit no.**

BOSCH

0-120-469-646	0-120-469-647	0-120-469-666	0-120-469-710	0-120-469-836	0-986-035-020
0-986-035-770					

**RB-53H**



\*120mm OD  
\*8-35 Amp Diodes

**Replaces**

**BOSCH :**

1-127-320-706

**FORD :**

6153350                      85GB-10304CA                      86GB-10304CA

**Unit no.**

BOSCH

0-120-469-009	0-120-469-032	0-120-469-659	0-120-469-660	0-120-469-661	0-120-469-662
0-120-469-713	0-120-469-747	0-120-469-748	0-120-469-871	0-120-469-874	0-120-469-899
0-120-469-958	0-986-034-140	0-986-036-000			

**RB-54H**



\*120mm OD  
\*8-35 Amp Diodes

**Replaces**

**AUDI/VW :**

037903359A      26903359      27903359

**BMW :**

12311715167

**BOSCH :**

1-127-320-705    1-127-320-715    1-127-320-723    1-127-320-725    1-127-320-728    1-127-320-732  
1-127-320-739    1-127-320-745    1-127-320-749

**LUCAS :**

UBB433

**MAGNETI MARELLI :**

940038208

**MERCEDES-BENZ :**

1545916

**OPEL :**

1205453      90349703      90443928

**Unit no.**

**BOSCH**

0-120-427-988	0-120-468-017	0-120-468-018	0-120-468-019	0-120-468-020	0-120-468-022
0-120-468-023	0-120-468-024	0-120-468-025	0-120-468-026	0-120-468-027	0-120-468-029
0-120-468-044	0-120-468-052	0-120-468-056	0-120-468-068	0-120-468-069	0-120-468-070
0-120-468-079	0-120-468-101	0-120-468-106	0-120-468-108	0-120-468-109	0-120-468-112
0-120-468-121	0-120-468-123	0-120-468-125	0-120-468-126	0-120-469-002	0-120-469-003
0-120-469-011	0-120-469-012	0-120-469-016	0-120-469-017	0-120-469-588	0-120-469-589
0-120-469-590	0-120-469-591	0-120-469-642	0-120-469-648	0-120-469-649	0-120-469-676
0-120-469-677	0-120-469-689	0-120-469-690	0-120-469-709	0-120-469-725	0-120-469-726
0-120-469-727	0-120-469-728	0-120-469-729	0-120-469-730	0-120-469-731	0-120-469-732
0-120-469-733	0-120-469-742	0-120-469-743	0-120-469-744	0-120-469-745	0-120-469-746
0-120-469-768	0-120-469-777	0-120-469-778	0-120-469-779	0-120-469-780	0-120-469-782
0-120-469-783	0-120-469-790	0-120-469-801	0-120-469-802	0-120-469-804	0-120-469-805
0-120-469-806	0-120-469-808	0-120-469-809	0-120-469-810	0-120-469-926	0-120-469-927
0-120-469-928	0-120-469-941	0-120-469-942	0-120-469-943	0-120-469-946	0-120-469-947
0-120-469-948	0-120-469-949	0-120-469-950	0-120-469-962	0-120-469-970	0-120-469-971
0-120-469-972	0-120-469-992	0-120-469-993	0-120-469-995	0-120-469-996	0-120-469-997
0-120-469-998	0-120-496-777	0-986-033-150	0-986-033-710	0-986-034-020	0-986-034-030
0-986-035-820	0-986-036-350	0-986-036-360	0-986-036-660	0-986-037-040	0-986-038-220
0-986-038-300	0-986-038-340				

**RB-55H**

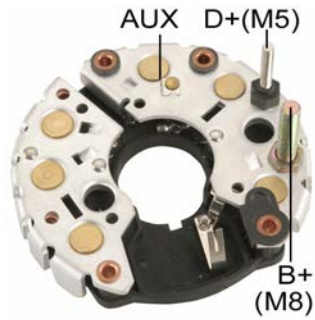

\*120mm OD  
\*6-35 Amp Diodes

**Replaces**

**BMW :**

12311288457

**BOSCH :**

1-127-320-702    1-127-320-709    1-127-320-722

**OPEL :**

1205455            90349855

**VOLVO/DAF :**

9130095

**Unit no.**

**BOSCH**

0-120-469-618	0-120-469-619	0-120-469-641	0-120-469-667	0-120-469-683	0-120-469-684
0-120-469-685	0-120-469-757	0-120-469-758	0-120-469-759	0-120-469-794	0-120-469-795
0-120-469-799	0-120-469-800	0-120-469-881	0-120-496-617	0-986-034-080	0-986-034-110
0-986-034-170					

**RB-56H**

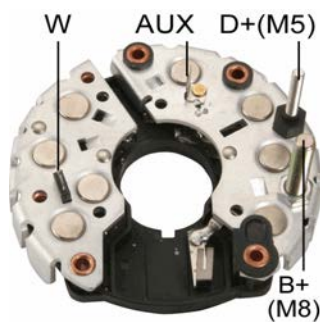

\*120mm OD  
\*8-35 Amp Diodes

**Replaces**

**AUDI/VW :**

75903359

**BOSCH :**

1-127-320-708    1-127-320-731

**LUCAS :**

UBB432

**MAGNETI MARELLI :**

940038206

**MERCEDES-BENZ :**

1547916

**Unit no.**

**BOSCH**

0-120-469-015	0-120-469-020	0-120-469-021	0-120-469-663	0-120-469-722	0-120-469-723
0-120-469-724	0-120-469-734	0-120-469-735	0-120-469-736	0-120-469-737	0-120-469-738
0-120-469-739	0-120-469-740	0-120-469-741	0-120-469-774	0-120-469-813	0-120-469-814
0-120-469-856	0-120-469-857	0-120-469-863	0-120-469-884	0-120-469-903	0-120-469-904
0-120-469-908	0-120-469-929	0-120-469-930	0-120-469-931	0-120-469-932	0-120-469-933
0-120-469-934	0-120-469-953	0-120-469-975	0-120-469-976	0-120-469-977	0-120-469-991



**RB-57H**



\*120mm OD  
\*6-35 Amp Diodes

**Replaces**

**BOSCH :**  
1-127-320-707

**FORD :**  
6153349                    85GB-1034BA

**Unit no.**

BOSCH  
0-120-469-655    0-120-469-656    0-120-469-657    0-120-469-658    0-120-469-781    0-986-034-010  
0-986-036-050    0-986-037-010

**RB-58H**



\*120mm OD  
\*8-35 Amp Diodes

**Replaces**

**BOSCH :**  
1-127-320-712    1-127-320-735

**Unit no.**

BOSCH  
0-120-469-784    0-120-469-785    0-120-469-786    0-120-469-787    0-120-469-793    0-120-469-838  
0-120-469-882    0-120-469-883    0-120-469-910    0-120-469-915    0-120-469-916    0-120-469-924  
0-120-469-935

**RB-59H**

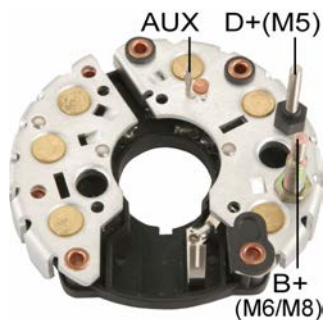

\*120mm OD  
\*6-35 Amp Diodes

**Replaces**

**BOSCH :**  
1-127-320-713

**VOLVO/DAF :**  
1398640

**Unit no.**

BOSCH  
0-120-468-009    0-120-468-010    0-120-468-011    0-120-468-012    0-120-468-015    0-120-468-016

**RB-60H**

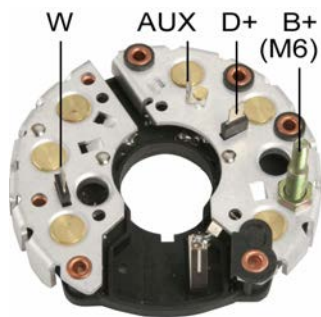

\*120mm OD  
\*6-35 Amp Diodes

**Replaces**

**BOSCH :**  
1-127-320-711  
**VOLVO/DAF :**  
1363741

**Unit no.**

BOSCH  
0-120-469-750    0-120-469-751    0-986-034-690

**RB-61H**

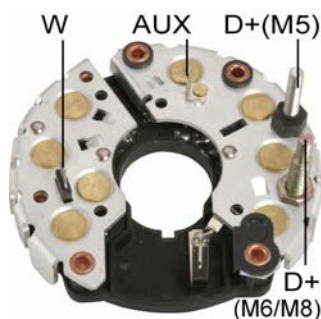

\*120mm OD  
\*8-35 Amp Diodes

**Replaces**

**BOSCH :**  
1-127-320-716  
**VOLVO/DAF :**  
3515707

**Unit no.**

BOSCH  
0-120-469-787    0-120-469-788    0-120-469-789

**RB-62H**

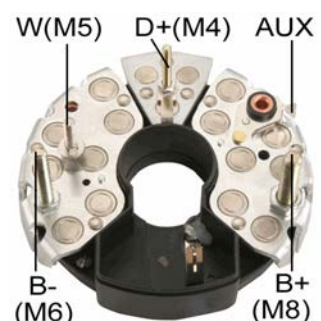

\*120mm OD  
\*14-35 Amp Diodes

**Replaces**

**BOSCH :**  
1-127-320-390    1-127-320-959

**Unit no.**

BOSCH  
0-120-469-014    0-120-469-522

**RB-63H**



\*120mm OD  
\*8-35 Amp Diodes

**Replaces**

**BOSCH :**

1-127-320-590    1-127-320-977

**Unit no.**

BOSCH

0-120-469-549    0-120-469-569    0-120-469-643    0-120-469-679

**RB-66H**

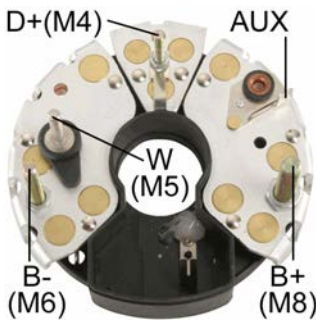

\*120mm OD  
\*8-50A Avalanche Diodes

**Replaces**

**BOSCH :**

1-127-320-602    1-127-320-924    1-127-320-951    1-127-320-955    1-127-320-980    1-127-320-981

**MAN :**

81261090016

**VOLVO :**

1698182

**Unit no.**

BOSCH

0-120-468-037    0-120-488-208    0-120-488-273    0-986-037-760

**RB-67H**

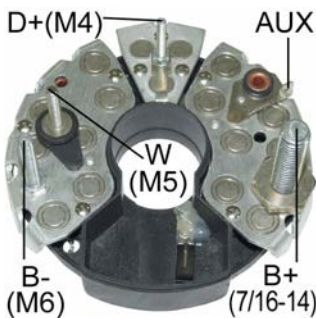

\*120mm OD  
\*14-50A Avalanche Diode

**Replaces**

**BOSCH :**

1-127-320-954

**Unit no.**

BOSCH

0-120-468-028    0-120-468-055

**RB-67HA**

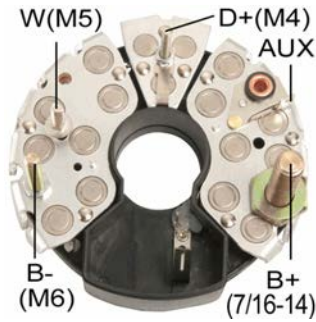

\* 120mm OD  
\* 14-50 Amp Diode

**Replaces**

**BOSCH :**  
1-127-320-920

**Unit no.**

BOSCH  
0-120-468-028    0-120-468-055

**RB-71H**

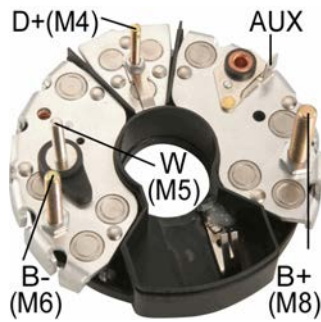

\*120mm OD  
\*8-50A Avalanche Diodes

**Replaces**

**BOSCH :**  
1-127-320-928    1-127-320-946    1-127-320-956    1-127-320-969    1-127-320-970    1-127-320-971  
1-127-320-989    1-127-320-990

**IVECO :**

93160252

**KHD :**

1318310

**MAN :**

81261090018

**VOLVO :**

3090260            3090262            68132

**Unit no.**

BOSCH  
0-120-465-010    0-120-468-107    0-120-468-113    0-120-468-114    0-120-468-124    0-120-468-131  
0-120-468-137    0-120-469-008    0-120-469-010    0-120-469-019    0-120-469-022    0-120-469-023  
0-120-469-025    0-120-469-026    0-120-469-027    0-120-469-030    0-120-469-031    0-120-469-891  
0-120-469-978    0-120-469-999    0-986-030-520    0-986-034-420    0-986-036-920

**RB-72H**

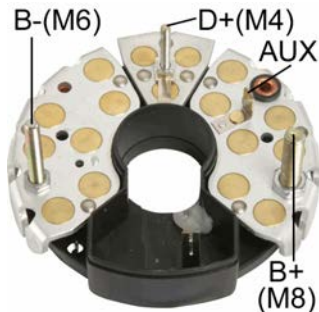

\*120mm OD  
\*14-35 Amp Diodes

**Replaces**

**AUDI/VW :**

049903359D

**BOSCH :**

1-127-320-361	1-127-320-379	1-127-320-386	1-127-320-388	1-127-320-395	1-127-320-543
1-127-320-653	1-127-320-654	1-127-320-655	1-127-320-656		

**FORD :**

613319                      83DB-10304AA

**LUCAS :**

UBB434

**VOLVO :**

244610                      698121

**Unit no.**

**BOSCH**

0-120-450-010	0-120-450-015	0-120-468-065	0-120-469-518	0-120-469-519	0-120-469-520
0-120-469-521	0-120-469-522	0-120-469-523	0-120-469-526	0-120-469-527	0-120-469-532
0-120-469-540	0-120-469-562	0-120-469-569	0-120-469-579	0-120-469-580	0-120-469-629
0-120-469-630	0-120-469-653	0-120-469-692	0-120-469-749	0-120-469-752	0-120-469-753
0-120-469-761	0-120-469-763	0-120-469-772	0-120-469-773	0-120-469-797	0-120-469-798
0-120-469-807	0-120-469-843	0-120-469-850	0-120-469-851	0-120-469-852	0-120-469-853
0-120-469-854	0-120-469-855	0-120-469-900	0-120-469-905	0-120-469-951	0-120-469-952
0-120-469-955	0-120-469-959	0-120-469-960	0-120-471-979	0-986-032-720	0-986-033-100
0-986-033-530	0-986-033-840	0-986-034-070	0-986-034-360	0-986-034-370	0-986-034-430
0-986-036-240					

**RB-73H**

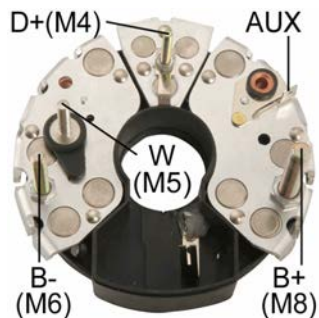

\*122mm OD  
\*M5 W Post  
\*8-35 Amp Diodes

**Replaces**

**BOSCH :**

1127320961	1127320388	1127320390	1127320395	1127320653	1127320654
1127320655	1127320656	1127320928	1127320946	1127320959	1127320960
1127320961	1127320969	1127320995	1127320361		

**RENAULT :**

1127320960

**Unit no.**

**BOSCH**

0-120-450-015	0-120-468-518	0-120-469-038	0-120-469-519	0-120-469-520	0-120-469-521
0-120-469-523	0-120-469-562	0-120-469-579	0-120-469-585	0-120-469-592	0-120-469-652
0-120-469-653	0-120-469-692	0-120-469-752	0-120-469-761	0-120-469-763	0-120-469-772
0-120-469-797	0-120-469-798	0-120-469-807	0-120-469-850	0-120-469-851	0-120-469-854
0-120-469-855	0-120-469-920	0-120-469-959	0-120-469-960		

**RB-74H**

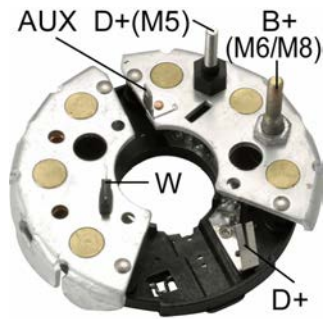

\*114mm OD  
\*6-50A Avalanche Diode

**Replaces**

**BOSCH :**  
1-127-319-104

**Unit no.**

BOSCH  
0-120-488-283

**RB-75H**



\*120mm OD  
\*M6 Battery Post  
\*6-35 Amp Diodes

**Replaces**

**BOSCH :**  
1-127-320-718    1-127-320-719

**Unit no.**

BOSCH  
0-120-450-012    0-120-450-014    0-120-450-016    0-120-450-017

**RB-77H**



\*120mm OD  
\*8-35 Amp Diodes

**Replaces**

**BOSCH :**  
1-127-320-720    1-127-320-741    1-127-320-911

**Unit no.**

BOSCH  
0-120-468-007    0-120-468-008    0-120-468-030    0-120-468-031    0-120-468-050    0-120-468-051  
0-120-468-067    0-120-468-095    0-120-468-096    0-120-469-775    0-120-469-776    0-120-469-989  
0-120-469-990    0-986-035-730    0-986-035-810

**RB-78H**

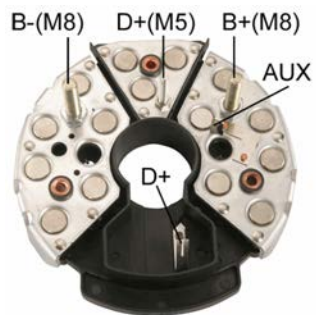

- \*145mm OD
- \*M8 Battery Post
- \*12-50A Avalanche Diodes

**Replaces**

**BOSCH :**

1-127-320-973

**IVECO :**

93163820

**KHD :**

1319100

**MERCEDES-BENZ :**

0011540816

**SCANIA :**

1347012

**VOLVO :**

3097306

**Unit no.**

**BOSCH**

0-120-689-533	0-120-689-534	0-120-689-535	0-120-689-538	0-120-689-539	0-120-689-540
0-120-689-541	0-120-689-542	0-120-689-543	0-120-689-545	0-120-689-546	0-120-689-549
0-120-689-550	0-120-689-551	0-120-689-552	0-120-689-553	0-120-689-555	0-120-689-557
0-120-689-558	0-120-689-559	0-120-689-561	0-120-689-562	0-120-689-563	0-120-689-564
0-120-689-566	0-120-689-567	0-120-689-569	0-120-689-570	0-120-689-571	0-120-689-572
0-120-689-573	0-120-689-574	0-120-689-575	0-120-689-576	0-120-689-577	0-120-689-582
0-120-689-583	0-120-689-584				

**RB-78HA**

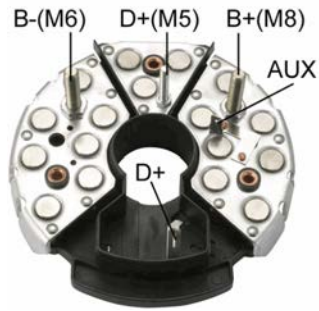

- \*145mm OD
- \*14-35 Amp Diodes
- \*With W terminal

**Replaces**

**BOSCH :**

1-127-320-547    1-127-320-550    1-127-320-571

**IVECO :**

8122274

**KHD :**

1320547

**MAGIRUS-DEUTZ :**

1309660

**MERCEDES-BENZ :**

0001545116    0001545416

**SAAB :**

424968

**VOLVO :**

1698762    696002

**Unit no.**

**BOSCH**

0-120-489-503	0-120-505-010	0-120-689-503	0-120-689-504	0-120-689-505	0-120-689-506
0-120-689-507	0-120-689-508	0-120-689-510	0-120-689-511	0-120-689-512	0-120-689-513
0-120-689-514	0-120-689-515	0-120-689-516	0-120-689-517	0-120-689-520	0-120-689-521
0-120-689-522	0-120-689-523	0-120-689-524	0-120-689-525	0-120-689-526	0-120-689-527
0-120-689-528	0-120-689-530	0-120-689-532	0-120-689-623	0-986-031-600	0-986-033-520
0-986-033-550	0-986-034-600	0-986-034-610	0-986-034-910		

**RB-79H**

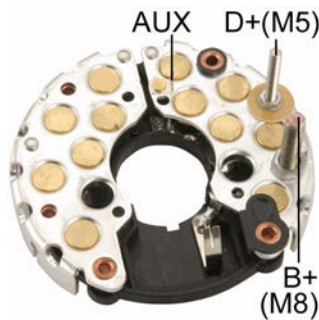

- \*120mm OD
- \*12-35 Amp Diodes
- \*With Anti Feed Back Diode

**Replaces**

**BOSCH :**

1-127-320-607

**Unit no.**

**BOSCH**

0-120-469-621	0-120-469-622	0-120-469-639	0-120-469-640
---------------	---------------	---------------	---------------



**RB-80H**

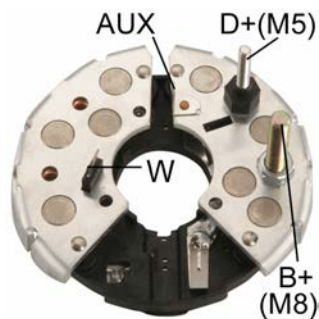

\*114mm OD  
 \*8-50A Avalanche Diode(19~24V)

**Replaces**

**BOSCH :**  
 1127320692

**Unit no.**

BOSCH  
 0-120-484-001    0-120-484-011    0-120-484-012    0-120-484-015    0-120-484-018    0-120-484-020  
 0-120-484-022    0-120-484-024

**RB-80HA**

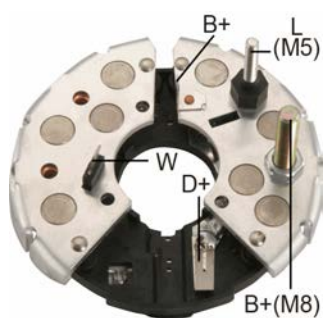

\*114mm OD  
 \*8-50A Avalanche Diodes(32~40V)

**Replaces**

**BOSCH :**  
 9-122-067-305

**RB-81H**

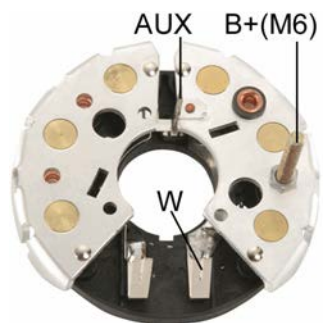

\*114mm OD  
 \*6-50A Avalanche Diode

**Replaces**

**BOSCH :**  
 9-121-067-379

**Unit no.**

BOSCH  
 9-120-060-027

**RB-82H**

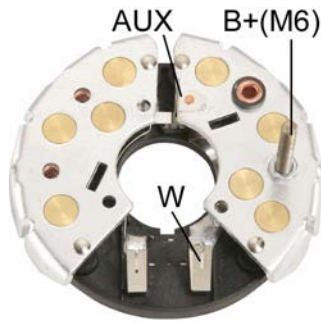

\*114mm OD  
\*8-35 Amp Diodes

**Replaces**

**FORD :**  
E9YJ-10304A

**Unit no.**

BOSCH  
9-120-060-020  
FORD  
E9YJ-10346A

**RB-83H**

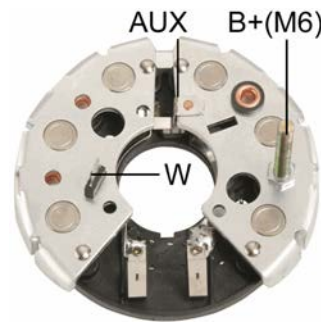

\*114mm OD  
\*6-50A Avalanche Diodes

**Unit no.**

BOSCH  
9-120-067-027

**RB-84H**

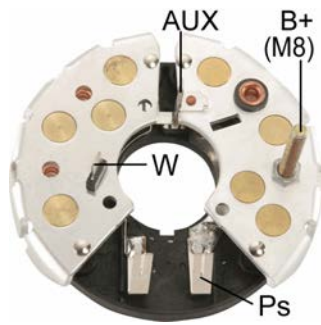

\*114mm OD  
\*8-50A Avalanche Diodes

**Replaces**

**BOSCH :**  
9121067067      9121067364      9121067371      9121067374      9121067375      9121067388  
9121067394

**Unit no.**

BOSCH  
9-120-060-009      9-120-060-023      9-120-060-027

**RB-85H**

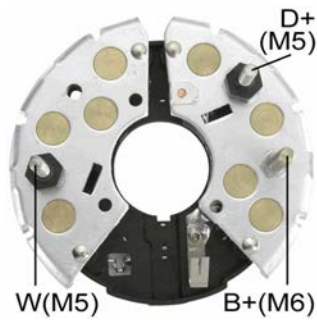

- \*114mm OD
- \*M6 Battery Post
- \*8-35 Amp Diodes

**Replaces**

**BOSCH :**  
9-128-040-953J

**Unit no.**

BOSCH  
9-120-180-020J

**RB-86H**

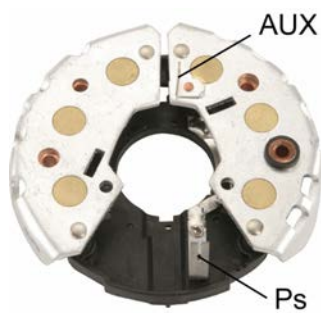

- \*114mm OD
- \*6-35 Amp Diodes

**Replaces**

**BOSCH :**  
1-127-320-903

**Unit no.**

BOSCH  
0-120-488-146    0-120-488-147    0-120-488-148    0-120-488-149    0-120-488-150    0-120-488-179  
0-120-488-180    0-120-488-181    0-120-488-243

**RB-87H**

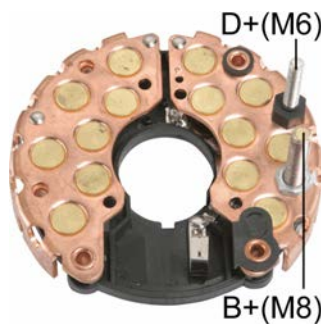

- \*120mm OD
- \*14-35 Amp Diodes

**Replaces**

**BOSCH :**  
1-127-320-901    1-127-320-912    1-127-320-918    1-127-320-938

**Unit no.**

BOSCH  
0-100-468-074    0-120-468-013    0-120-468-014    0-120-468-032    0-120-468-048    0-120-468-049  
0-120-468-071    0-120-468-072    0-120-468-073    0-120-468-097    0-120-468-098



**RB-929HV**

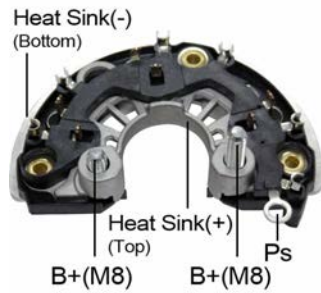

- \*M8 Battery Post
- \*130mm OD
- \*Delta connection
- \*6-70A Avalanche Diodes
- \*Replace to part number RB-129HV

**Replaces**

**BOSCH :**

F-00M-133-215    F-00M-133-218    F-00M-133-247    F-00M-133-259    F-00M-133-229

**MEC(OLD) :**

RB-129HV

**Unit no.**

BOSCH

6-004-ML0-017    6-004-ML0-021

**RB-92H**

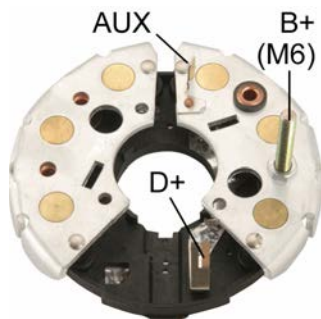

- \*114mm OD
- \*6-50A Avalanche Diode

**Replaces**

**BOSCH :**

9-122-337-307

**Unit no.**

BOSCH

9-120-334-631    9-120-334-632

**RB-93H**

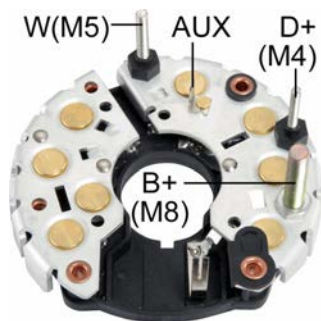

\*120mm OD  
\*8-50A Avalanche Diodes

**Replaces**

**BOSCH :**

1127320753      1127320750

**DAF :**

132114

**IVECO :**

42531816

**MERCEDES-BENZ :**

0005481416      0011542216

**Unit no.**

**BOSCH**

0 120 468 143    0 120 468 145    0 120 469 101    0 120 469 107    0 120 469 108    0 120 469 109

0 120 469 110    0 120 469 111    0 120 469 112    0 120 469 113    0 120 469 114    0 120 469 115

0 120 469 116    0-120-469-100    0-120-469-102    0-120-469-103

**MERCEDES-BENZ**

0101549102      0101549202

**RB-952H**

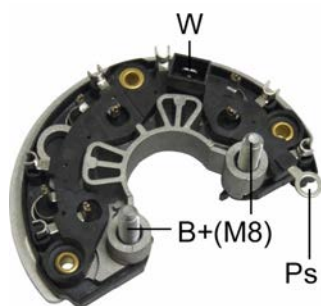

\*130mm OD  
\*M8 Battery Post  
\*6-50 Avalanche Diodes  
\*Replace to part number RB-152H

**Replaces**

**BOSCH :**

F-00M-133-269

**MEC(OLD) :**

RB-152H

**RB-954H**



- \*130mm OD
- \*M6 Battery Post
- \*6-70A Avalanche Diodes
- \*Replace to part number RB-154H

**Replaces**

**BOSCH :**  
F-00M-133-277  
**MEC(OLD) :**  
RB-154H

**Unit no.**

BOSCH  
0-124-525-072

**RB-96H**

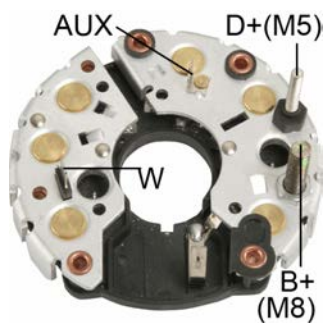

- \*120mm OD
- \*6-35 Amp Diodes

**Replaces**

**BOSCH :**  
1-127-320-743

**Unit no.**

BOSCH  
0-120-468-080    0-120-468-081    0-120-468-084    0-120-468-085    0-120-468-086    0-120-468-119  
0-120-468-120

**RC-19**

\*3-50 Amp Diodes  
\*Without Terminal

Heat Sink(+)  
Top



Heat Sink(-)  
Bottom

**Replaces**

**CHRYSLER :**  
4364855      4467162      5226009

**RC-21N**

\*Negative  
\*3-25 Amp Diodes

Heat Sink (-)



**Replaces**

**CHRYSLER :**  
3438721      3755114

**RC-21P**

\*Positive  
\*3-25 Amp Diodes

Heat Sink(+)

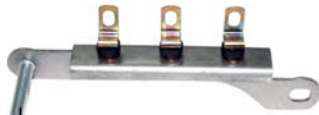

B+ (1/4-20uNC)

**Replaces**

**CHRYSLER :**  
3438727      3874268      3874269      3874343      4026082      4026083  
4026282      4240488



**RD-16**

\*8-50 Amp Diodes



**Replaces**

DAEWOO :

262100	267000	276000
--------	--------	--------

**RD-32**

\*6-50A Avalanche Diodes

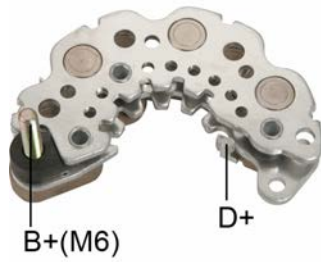

**Unit no.**

DAEWOO

219170	96380673	266000
--------	----------	--------

DELCO

19020601	19020609	19020611	19020612
----------	----------	----------	----------

**RD-04B**

\*O.E. TYPE with 6-50A Avalanche Diodes

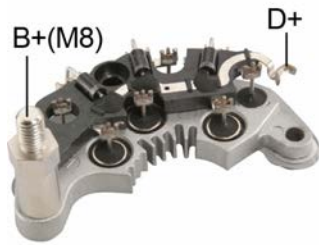

**Replaces**

**DELCO :**

10475034	1205464	589714	10475034
----------	---------	--------	----------

**Unit no.**

**DELCO**

10479914	10479923	10479947	10479955	3493947
----------	----------	----------	----------	---------

**RD-05**

\*6-50 Amp Diodes  
\*Wide Fin Gull Wing Style Heat Sinks



**Replaces**

**DELCO :**

1988976	D3987
---------	-------

**Unit no.**

**DELCO**

1105585	1105680	1105683	1105690	1117880	1117894
1117910	1117923	1117953	1117956	19010105	

**RD-06**

\*6-50A Avalanche Diodes  
\*Wide Fin Gull Wing Style Heat Sink  
\*For use on 21SI, CS144 100A Alternators



**Replaces**

**BOSCH :**

111233	111240
--------	--------

**DELCO :**

10469265	D3929
----------	-------

**Unit no.**

**DELCO**

1117886	1117892	1117937
---------	---------	---------

**RD-06A**



- \*3-50A Diodes, 3-50A Avalanche diodes
- \*Wide Fin Gull Wing Style Heat Sinks
- \*For use on 21SI, CS144 100A Alternators

**Replaces**

**DELCO :**

10471170	1989774	10467052	10470609	D3990	D3992
D3931					

**Unit no.**

**DELCO**

1117895	1117903	1117927	1117932	1117957	1117958
1117959					

**RD-06B**



- \*6-50A Avalanche Diodes
- \*Wide Fin Gull Wing Style Heat Sink
- \*Heavy Duty Version of RD-06 for use on 21SI, CS144 120A Alternators

**RD-07**

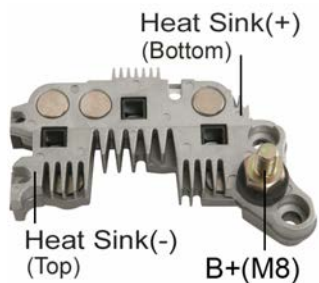

- \*6-50A Avalanche Diodes
- \*Wide Fin Gull Wing Style Heat Sinks
- \*CS144 Alternators

**Replaces**

**DELCO :**

10475800

**Unit no.**

**DELCO**

10479891	10479966	10480010	1102625
----------	----------	----------	---------

**RD-08**

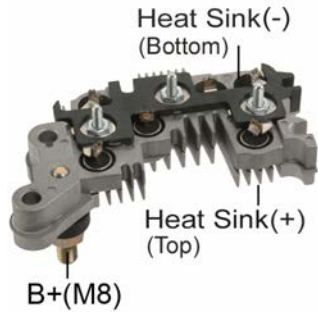

- \*6-50A Avalanche Diodes
- \*Wide Fin Gull Wing Style Heat Sinks
- \*CS144 Alternators

**Replaces**

**DELCO :**  
10472095

**Unit no.**

DELCO					
104080200	10479821	10479852	10479891	10479966	10479995
1048008	10480111	10480139	1101580	1101850	1102625

**RD-09**

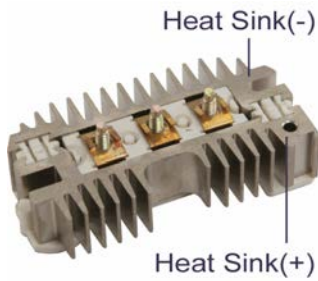

- \*6-25 Amp Diodes
- \*10SI,20SI,30SI Series
- \*Negative Ground Version of RD-30
- \*(RD-30 is Positive Ground Version.)

**Replaces**

**DELCO :**  
1852209      1875627      1891055      1971987      1984638      D3915

**Unit no.**

DELCO					
1100499	1102916	1102921	1102934	1102935	1103116
1103123	1103129	1103190			

**RD-09H**

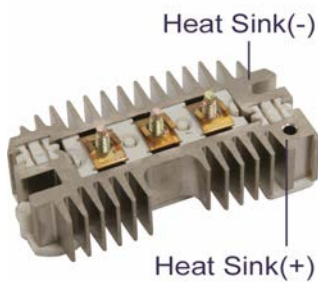

- \*6-35 Amp Diodes
- \*For DELCO 10SI, 20SI, 30SI alternators
- \*Negative Ground Version of RD-30H
- \*(RD-30H is Positive Ground Version.)
- \*Economy Version: RD-09HA

**Replaces**

**DELCO :**  
1852209      1875627      1891055      1971987      1984638      D3915

**Unit no.**

DELCO					
1100499	1102916	1102921	1102934	1102935	1103116
1103123	1103129	1103190			

**RD-10**

\*6-25 Amp Diodes

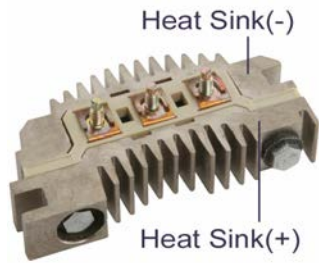

**Replaces**

<b>DELCO :</b>			
3472311	7982716	7982718	DR1000

**Unit no.**

DELCO					
3472002	3472004	3472008	3472014	3472018	3472022
3472023	3472024	3472025	3472026	3472027	3472028
3472032	3472033	3472037	3472038		

**RD-10H**

\*6-35 Amp Diodes

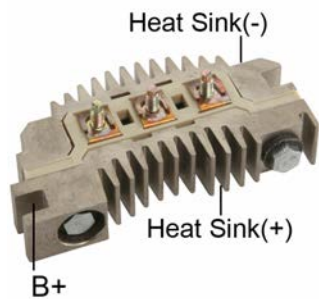

**Replaces**

<b>DELCO :</b>			
3472311	7982716	7982718	DR3900

**RD-10HV**

\*6-50 Amp Diodes

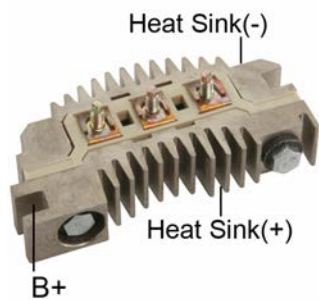

**Replaces**

<b>DELCO :</b>
7332312

**Unit no.**

DELCO					
3027014	3720002	3720004	3720008	3720018	3720022
3720023	3720024	3720026	3720027	3720028	3720032
3720037					

**RD-11**

\*6-25 Amp Diodes

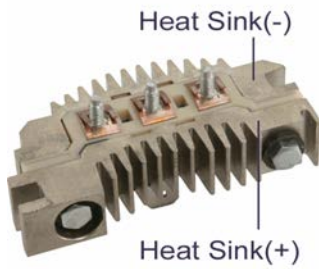

**Replaces**

**DELCO :**

7982623	7982659	7982756	7982772
---------	---------	---------	---------

**Unit no.**

**DELCO**

7892744	7982574	7982575	7982600	7982601	7982604
7982605	7982645	7982648	7982652	7982657	7982674
7982698	7982699	7982703	7982704	7982705	7982707
7982710	7982717	7982720	7982721	7982728	7982738
7982739	7982740	7982741	7982742	7982743	7982744
7982745	7982747	7982748	7982749	7982750	7982752
7982753	7982758	7982759	7982762	7982766	7982778
7982787	7982811	7982812	7982822	7982854	7982856
7982857	7982864	7982865	7982872	7982873	7982874
7982875	7982952	7982953	7982981	7982986	7982988

**RD-11H**

\*6-35 Amp Diodes

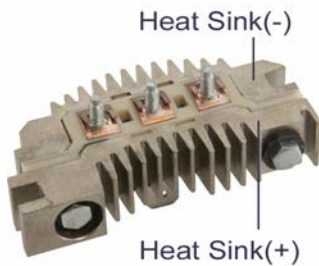

**Replaces**

**DELCO :**

7982623	7982659	7982756	7982772
---------	---------	---------	---------

**VW/BRAZIL :**

31-127

**RD-12**

\*6-25 Amp Diodes  
\*12SI Series

Heat Sink(-)



Heat Sink(+)

**Replaces**

**DELCO :**

1984454                      D3924

**Unit no.**

DELCO

1100200	1100207	1100208	1100240	1100241	1100242
1100258	1101285	1101439	1101440	1105367	1105440
1105536	1105538				

**RD-13HV**

\*6-50 Amp Diodes  
\*For 12SI Alternators

Heat Sink(-)



Heat Sink(+)

**Replaces**

**DELCO :**

1987061                      D3986

**Unit no.**

DELCO

1005425	1005428	1005493	1105425	1105428	1105493
---------	---------	---------	---------	---------	---------

**RD-14**

\*6-25 Amp Diodes  
\*15SI 70-85 Amp Series  
\*Positive Ground Version  
\*(RD-31 is Negative Ground Version)

Heat Sink(+)



Heat Sink(-)

**Replaces**

**DELCO :**

1975313                      D3919

**Unit no.**

DELCO

1100184	1100190	1100192	1101077	1101096	1101438
1101446					

**RD-14H**

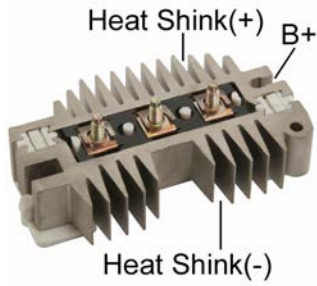

- \*6-35 Amp Diodes
- \*15SI 70-85 Amp Series
- \*Positive Ground Version
- \*(RD-31H is Negative Ground Version.)
- \*Economy Version: RD-14HA

**Replaces**

**DELCO :**

1975313                      D3919

**Unit no.**

DELCO

1100184	1100190	1100192	1101077	1101096	1101438
1101446					

**RD-15**

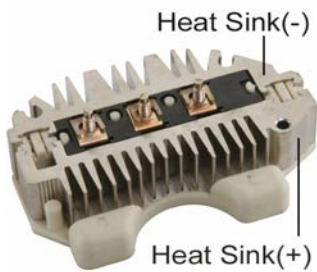

- \*6-25 Amp Diodes
- \*6 Pos. & 3 Neg. Diodes
- \*17SI 97-108 Amp

**Replaces**

**DELCO :**

1985801                      D3985

**Unit no.**

DELCO

1105085	1105450	1105451	1105491	1105513
---------	---------	---------	---------	---------

**RD-15H**

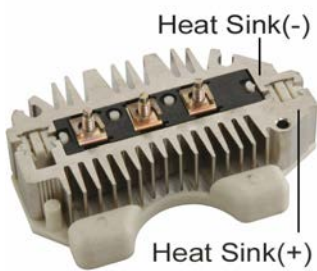

- \*6-35 Amp Diodes
- \*6 Pos. & 3 Neg. Diodes
- \*17SI 97-108 Amp
- \*Economy Version: RD-15HA

**Replaces**

**DELCO :**

1985801                      D3985

**Unit no.**

DELCO

1105085	1105450	1105451	1105491	1105513
---------	---------	---------	---------	---------



**RD-17**

\*6-25 Amp Diodes  
 \*27SI, Type 100,200,29SI,30SI Negative Ground Alternators

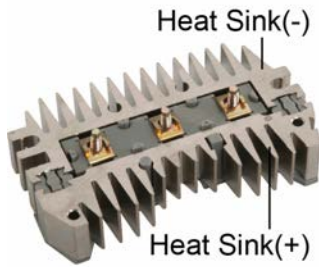

**Replaces**

**DELCO :**

1875645	1892914	801816	D3982	D3983
---------	---------	--------	-------	-------

**Unit no.**

DELCO

1100077	1100078	1100080	1100095	1100177	1101015
1101016	1101018	1101020	1101091	1101450	1101550
1105472	1105477	1117160	1117163	1117732	1117801
1117805	1117807	1117818			

**RD-17H**

\*6-35 Amp Diodes  
 \*27SI Type 100,200,29SI,30SI Negative Ground Alternators

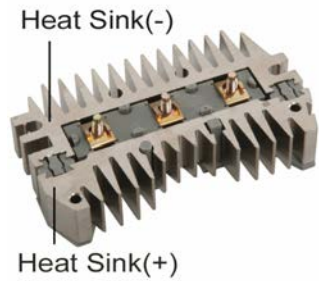

**Replaces**

**CATERPILLAR :**

9L6776

**DELCO :**

1875645	1892914	801816	D3982	D3983	1975645
---------	---------	--------	-------	-------	---------

**Unit no.**

DELCO

1100077	1100078	1100080	1100095	1100177	1101015
1101016	1101018	1101020	1101091	1101450	1101550
1105472	1105477	1117160	1117163	1117732	1117801
1117805	1117807	1117818			

**RD-18H**

\*6-35 Amp Diodes  
 \*Economy Version: RD-18HA

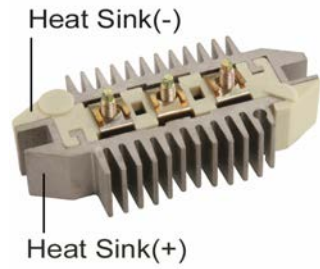

**Replaces**

<b>DELCO :</b>			
3472813	3493714	3493721	6065301
<b>OPEL :</b>			
1205409			

**Unit no.**

DELCO					
3472057	3472058	3472059	3472060	3472061	3472062
3472065	3472066	3472067	3472068		
OPEL					
1204012	1204013	1204015	1204018	1204020	1204021
1204040	1204043	1204045	1204068	1204088	1204095
1204109	1204112	1204121	1204203	1204217	

**RD-18HA**

\*6-35 Amp Diodes



**Replaces**

<b>DELCO :</b>			
3472813	3493714	3493721	6065301
<b>OPEL :</b>			
1205409			

**Unit no.**

DELCO					
3472057	3472058	3472059	3472060	3472061	3472062
3472065	3472066	3472067	3472068		
OPEL					
1204012	1204013	1204015	1204018	1204020	1204021
1204040	1204043	1204045	1204068	1204088	1204095
1204109	1204112	1204121	1204203	1204217	

**RD-20HA**

\*6-35 Amp Diodes



**Replaces**

<b>DELCO :</b>					
3493008	3493417	3493716	3493717		
<b>OPEL :</b>					
1205454					

**Unit no.**

DELCO					
3742106	3742121	3742130	3742134	3742137	3742144
OPEL					
1204100	1204131	1204219			

**RD-21**

\*6-25 Amp Diodes

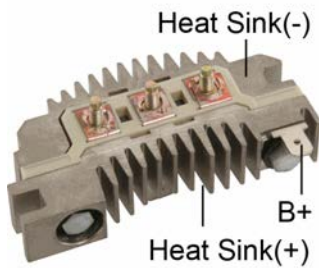

**Replaces**

<b>DELCO :</b>		
3472820	3478627	3478687

**Unit no.**

DELCO			
3472020	3472021	3472063	3472064

**RD-21H**

\*6-35 Amp Diodes

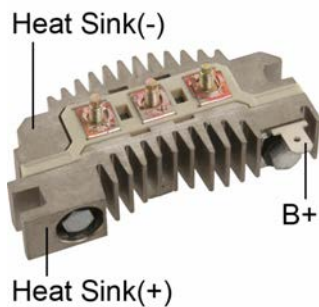

**Replaces**

<b>DELCO :</b>		
3472820	3478627	3478687

**Unit no.**

DELCO			
3472020	3472021	3472063	3472064

**RD-22**

\*6-25 Amp Diodes  
\*40SI Series

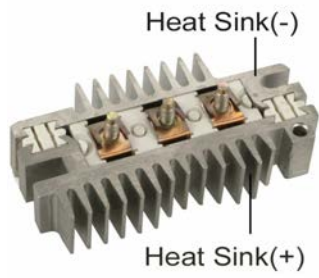

**Replaces**

DELCO :  
1867531

Unit no.

DELCO  
1117148

**RD-22H**

\*6-35 Amp Diodes  
\*40SI Alternators

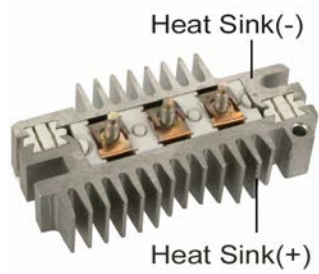

**Replaces**

DELCO :  
1867531

Unit no.

DELCO  
1117148

**RD-25A**

\*6-50A Avalanche Diodes

Heat Sink(+) Top



Heat Sink(-) Bottom

**Replaces**

DELCO :  
10492300

**RD-26**

\*6-50A Avalanche Diodes

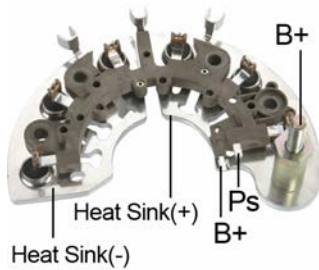

**Replaces**

DELCO :  
10494744

**Unit no.**

DELCO					
10480229	10480234	10480241	10480244	10480303	10480326
10480327	10480341	10480388	10480428		

**RD-26HD**

\*6-70A Avalanche Diodes

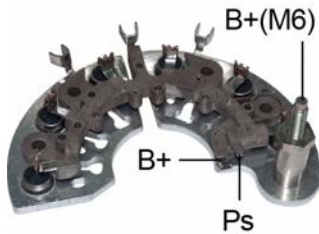

**Replaces**

DELCO :  
10494503

**Unit no.**

DELCO					
10310982	10311493	10464395	10464405	10464406	10464408
10464430	10464440	10464441	10464442	10464443	10464452
10464453	10464456	10464460	10464461	10464466	10464467
10464468	10464469	10464476	10464480	10464482	10464485
10464487	10464488	10464489	10464492	10464493	10480231
10480234	10480244	10480270	10480285	10480298	10480303
10480327	10480341	10480350	10480357	10480368	10480383
10480390	10480414	10480428	10480480	10494492	15056099
15056100	15062413	15087022	15087024	15162839	15750871
15754097	15768830	15769253	15769254	25744162	25744163
25744165					

**RD-27H**

\*6-35 Amp Diodes  
 \*For 25SI Alternators, Negative Ground

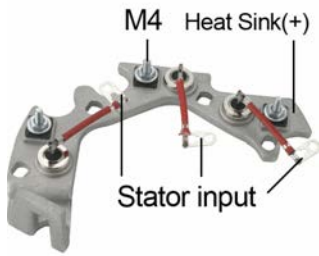

**Replaces**

<b>DELCO :</b>		
1971670	1851437	1969132
<b>VALEO :</b>		
593797	2650430	

**Unit no.**

DELCO					
10459003	10459006	1117155	1117225	1117226	1117227
1117228	1117231	1117233	1117234		

**RD-28H**

\*6-35 Amp Diodes  
 \*For 25SI Alternators, Positive Ground

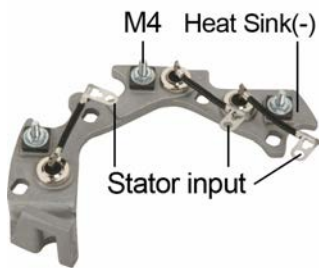

**Replaces**

<b>DELCO :</b>
1971867

**Unit no.**

DELCO		
1117232	1117235	1117245

**RD-29**

\*6-50A Avalanche Diodes



**Replaces**

<b>DELCO :</b>			
10493596	3472020	3472820	3478687
<b>OPEL :</b>			
6205432			

**Unit no.**

DELCO	
90543910	UD12AB
OPEL	
6204072	

**RD-30**

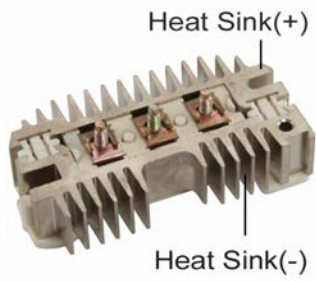

\*6-25 Amp Diodes  
 \*Positive Ground Version of RD-09

**Replaces**

DELCO :  
 233195

**RD-31**

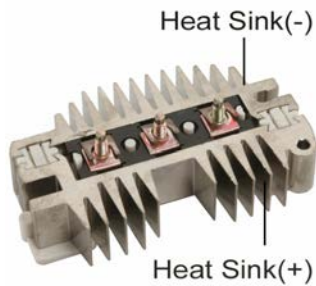

\*6-25 Amps Diodes  
 \*15SI 70-85 Amps Alternators  
 \*Negative Ground Version  
 \*(RD-14 is Positive Ground Version.)

**Replaces**

DELCO :  
 1975313                      D3919

**Unit no.**

DELCO					
1100184	1100190	1100192	1101077	1101096	1101438
1101446					

**RD-31H**

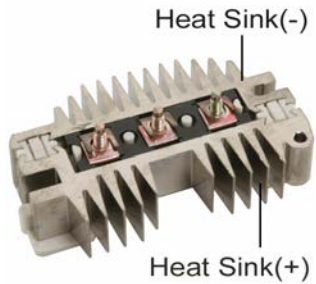

\*6-35 Amps Diodes  
 \*15SI 70-85 Amps Alternators  
 \*Negative Ground Version  
 \*(RD-14H is Positive Ground Version.)  
 \*Economy Version: RD-31HA

**Replaces**

DELCO :  
 1975313                      D3919

**Unit no.**

DELCO					
1100184	1100190	1100192	1101077	1101096	1101438
1101446					

**RD-33**

\*6-50A Avalanche Diodes  
 \*M8 Battery Post

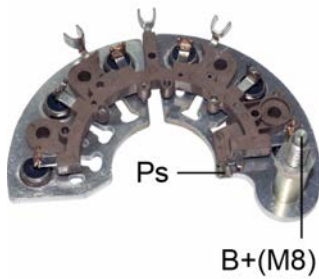

**Replaces**

DELCO :  
 19055072

Unit no.

DELCO  
 10333165      10442783      10333166      10442782

**RD-33HD**

\*6-50A Avalanche Diodes  
 \*M8 Battery Post

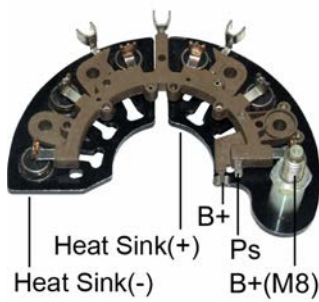

Unit no.

DELCO  
 10346705

**RD-35**

\*35SI Series  
 \*6-70A Avalanche Diodes

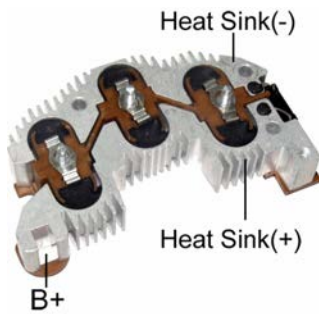

**Replaces**

DELCO :  
 10511353



**RD-35A**

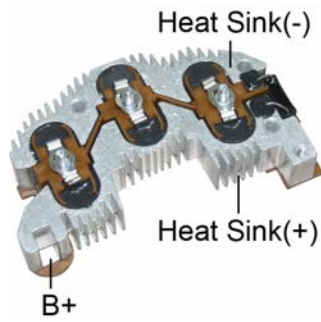

\*23SI, 33SI, 34SI Series  
 \*For 24V System  
 \*6-70A(38-43V) Avalanche Diodes

**Replaces**

DELCO :

10501635                      10512366

**Unit no.**

DELCO

19011004                      19011015                      19011019

**RD-36**

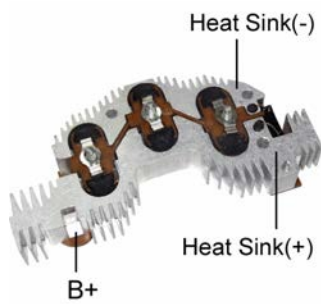

\*6-70A Avalanche Diodes  
 \*36SI Series

**Replaces**

DELCO :

10512371

**RD-37**

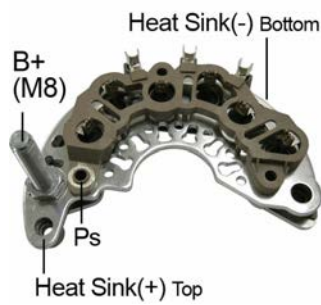

\*6-35A Avalanche Diodes  
 \*M8 Battery Post

**Unit no.**

GM

96540542                      96838439

**Used On**

**CHEVROLET**

Aveo    1.6L    2004-2007

**SUZUKI**

Swift    1.6L    2004-2005

**RD-38**

\*6-50A Avalanche Diodes(32~40V)

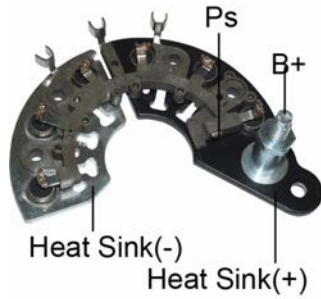

**Replaces**

DELCO :  
10510456

**Unit no.**

DELCO  
8600016            8600017            8600154

**RD-38A**

\*6-50A Avalanche Diodes(24~32V)

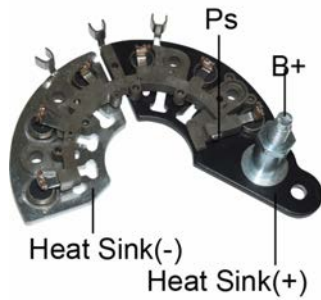

**Replaces**

DELCO :  
10502870

**Unit no.**

DELCO  
19202900            19202901            19202902            19202903

**RD-39H**

\*6-35A Avalanche Diodes  
\*M8 Battery Post

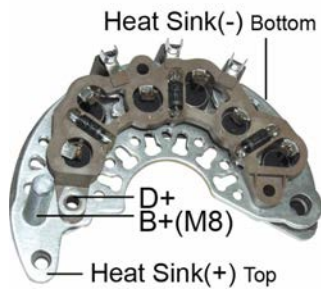

**Unit no.**

DELCO  
1861166  
SUZUKI  
31400-85Z00            31400-85Z01

**Used On**

**SUZUKI**

Forenza Base	4Cyl 2.0L GAS	2006-
Forenza EX	4Cyl 2.0L GAS	2004-2005
Forenza LX	4Cyl 2.0L GAS	2004-2005
Forenza Premium	4Cyl 2.0L GAS	2006-
Forenza S	4Cyl 2.0L GAS	2004-2005

**RD-40H**

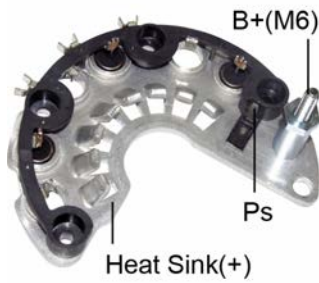

- \*M6 Battery Post
- \*3-70A Avalanche Diodes
- \*Same as RD-40HA but w/o S.R.E frame
- \*Regitar No.: RD-40HS

**Replaces**

**DELCO :**

10503581                      10510904

**Unit no.**

DELCO

10392759                      15200109                      15200268                      15263858

**RD-40HA**



- \*150mm OD
- \*6-70A Avalanche Diodes
- \*M6 Battery Post
- \*Negative & Positive Assembly
- \*Same as RD-40H but w/S.R.E. frame
- \*Regitar No.: RD-40H

**Replaces**

**DELCO :**

10503581                      10510904

**Unit no.**

DELCO

10392759                      15200109                      15200110                      15200268                      15263858                      18000002

**RD-41**

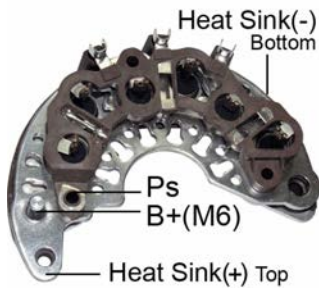

- \*6-50A Avalanche Diodes
- \*M6 Battery Post

**Unit no.**

DELCO

96408588

SUZUKI

31400-85Z00                      31400-85Z01

**RD-43**

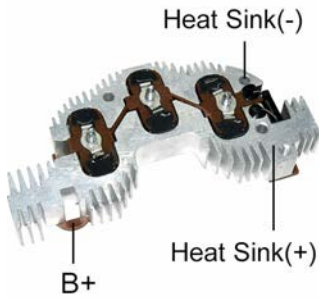

**Replaces**

DELCO :  
10514498

**Unit no.**

DELCO  
8600110                      8600111

**RD-95A**

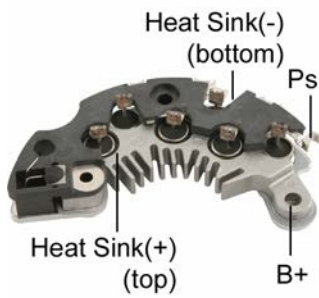

\*6-60A Avalanche Diodes  
\*For CS121,CS130 Series Alternators

**Replaces**

DELCO :  
1989658                      D3991

**Unit no.**

DELCO					
1101227	1101266	1101267	1101271	1101465	1101467
1101478	1101480	1101565	1101583	1101599	1101605
1101608	1101612	1101816	1102601	1102617	1102644
1105667	1105725	3211068	321338	321344	321348
321349	321350	321351	321352	321353	321365
321424	321425	321430	321435	321436	321455
321457	321469	321496	321523	CS121	CS130

**RD-95HD**



\*6-70A Avalanche Diodes  
\*For CS121,CS130 Series Alternators

**RD-96**

\*6-50A Avalanche Diodes

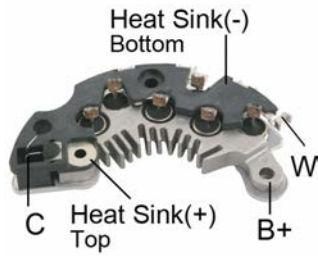

**Replaces**

**DELCO :**

1989658	D3991	10456401	10457236	10457690	10470730
10472597					

**Unit no.**

**DELCO**

1101227	1101266	1101267	1101271	1101465	1101467
1101468	1101480	1101583			

**RD-97A**

\*6-50A Avalanche Diodes  
 \*M8 x 36.5mm Battery Post w/14mm Thread  
 \*For CS130D Series

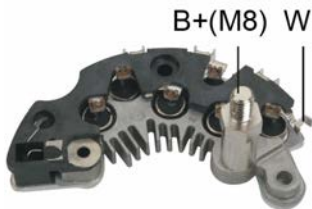

**Replaces**

**DELCO :**

10475758	CS130D
----------	--------

**Unit no.**

**DELCO**

10463443	10479981	10479984	10480017	10480043	10480052
10480071	10480072	10480119	3211008	3211023	3211025
3211026	3211027	3211031	3211048	3211051	CS130DALTERNAT

**RD-97B**

\*6-50A Avalanche Diodes  
 \*M8 x 32.5mm Battery Post w/11mm Thread



**RD-97D**

\*6-50A Avalanche Diodes  
 \*M6 x 30.8mm Battery Post

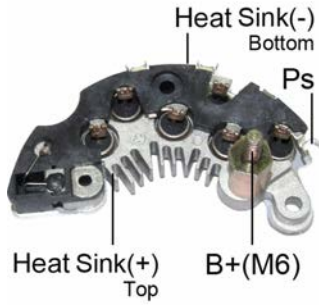

**Replaces**

DELCO :  
 10491097      10492837      10492838

**Unit no.**

DELCO  
 10479214      10480190

**RD-97HD**

\*6-70A Avalanche Diodes  
 \*For CS130D Alternators



**RD-97HV**

\*6-50A Avalanche Diode Chips  
 \*For CS130D Alternators



**Replaces**

DELCO :  
 10475758

**Unit no.**

DELCO  
 10463443      3211008      3211023      3211025      3211026      3211027  
 3211031      3211048      3211051

**RD-98A**

\*6-50A Avalanche Diodes  
 \*Same as RD-97A but w/o Battery Post



**RD-99**

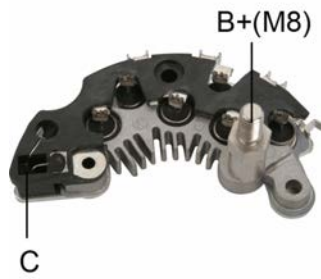

- \*M8 Battery Post
- \*6-50A Avalanche Diodes
- \*For CS121,CS130 Series

**Replaces**

**DELCO :**

10475758	10491097	10492838
----------	----------	----------

**Unit no.**

DELCO

10463443	3122026	3211008	3211023	3211025	3211027
3211031	3211048	3211051			

**RN-01**



- \*103mm OD
- \*M6 Battery Post
- \*8-50 Amp Diodes
- \*With Mounting Hole for Ground Strap

**Replaces**

**DENSO :**

021580-3640    021580-4660    021580-4840    021580-3680    021580-4120

**Unit no.**

DENSO

0121000-3000	0121000-3100	0121000-3300	0121000-3310	0121000-3330	0121000-3360
0121000-3370	0121000-3380	0121000-3390	0121000-3400	0121000-3410	0121000-3430
0121000-3440	0121000-3450	0121000-3480	100211-8230	100211-8320	100211-8370
100211-8530	100211-8590	100211-8810	100211-8820	100211-8870	101211-5220
101211-5460	101211-5550				

**RN-01P**

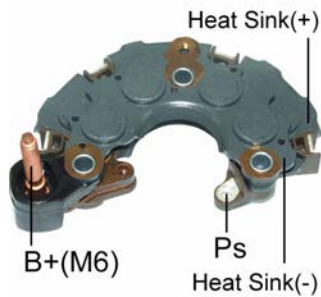

- \*103mm OD
- \*M6 Battery Post
- \*8-35A Avalanche Press-fit Diodes
- \*With Mounting Hole for Ground Strap

**Unit no.**

DENSO

100211-8230    100211-8320    100211-8370    100211-8530    101211-5220    101211-5460

101211-5550

**RN-01PL**

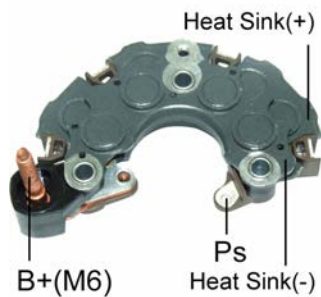

- \*103mm OD
- \*M6 Battery Post
- \*8-35A Avalanche Press-fit Diodes
- \*Aluminum Heat Sinks
- \*With Mounting Hole for Ground Strap

**Unit no.**

DENSO

100211-8230    100211-8320    100211-8370    100211-8530    101211-5220    101211-5460

101211-5550



**RN-02**



- \*113mm OD
- \*M6 Battery Post
- \*With Mounting Hole for Ground Strap
- \*8-50 Amp Diodes

**Replaces**

**DENSO :**  
021580-4820

**Unit no.**

CHRYSLER

5233599            5233608            5233660            5234651

DENSO

121000-4000        121000-4010        121000-4030        121000-4040        121000-4050        121000-4060

121000-4070        121000-4080        121000-4090        121000-4130

**RN-03**

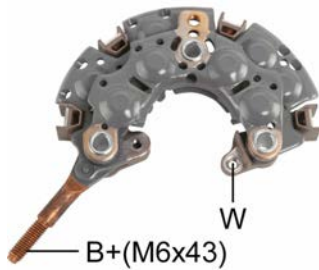

- \*103mm OD
- \*M6 Battery Post
- \*With Mounting Hole for Ground Strap
- \*8-50 Amp Diodes

**Replaces**

**DENSO :**  
021580-3830        021580-4080        021580-4480        021580-4630

**Unit no.**

DENSO

100211-5110        100211-5150        100211-5270        100211-5620        100211-8020        100211-8030

100211-8050        100211-8070        100211-8150        100211-8300        100211-8380        100211-8390

100211-8540        100211-8550        100211-8560        100211-8570        100211-8740        100211-8750

100211-8770        100211-8860        100211-8911        100211-9330        101211-9960        101211-9230

GM

94847129

TOYOTA

27060-0D010        27060-16230        27060-42030

**Used On**

**TOYOTA**

Corolla 4Cyl. 1.8L	2002-
RAV4 4Cyl. 2.0L	2003-
RAV4 4Cyl. 2.4L	2004-2005

**RN-03PL**

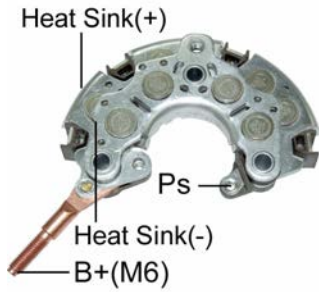

- \*103mm OD
- \*M6 Battery Post
- \*With Mounting Hole for Ground Strap
- \*8-50 Amp Press-fit Diodes
- \*Aluminum Heat Sinks

**Replaces**

**DENSO :**

021580-3830	021580-4080	021580-4480	021580-4630	012580-4510	012580-4760
021580-3660	021580-4030	021580-5160	021580-5810		

**HONDA :**

31127-PT0-003

**TOYOTA :**

27357-16310	27357-55080	27357-62040	27357-74050	27357-74160	
-------------	-------------	-------------	-------------	-------------	--

**Unit no.**

**DENSO**

100211-5110	100211-5150	100211-5270	100211-5620	100211-8020	100211-8030
100211-8050	100211-8070	100211-8150	100211-8300	100211-8380	100211-8390
100211-8540	100211-8550	100211-8560	100211-8570	100211-8740	100211-8750
100211-8770	100211-8860	100211-8911	100211-9330	101211-9230	

**GM**

94847129

**TOYOTA**

27060-16230	27060-42030				
-------------	-------------	--	--	--	--

**Used On**

**TOYOTA**

Corolla 4Cyl. 1.8L	2002-
RAV4 4Cyl. 2.0	2003-
RAV4 4Cyl. 2.4L	2004-2005

**RN-04**

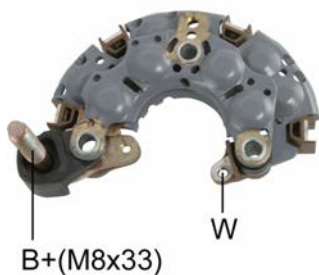

- \*103mm OD
- \*M8 Battery Post
- \*With Mounting Hole for Ground Strap
- \*8-50 Amp Diodes

**Replaces**

**DENSO :**

021580-4850

**Unit no.**

**DENSO**

100211-8620	100211-8630				
-------------	-------------	--	--	--	--

**RN-05**

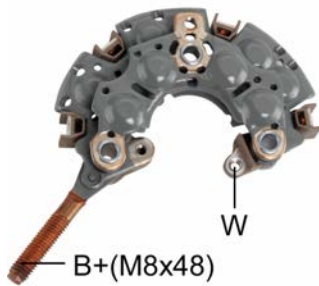

- \*103mm OD
- \*M8 Battery Post
- \*With Mounting Hole for Ground Strap
- \*8-50 Amp Diodes

Unit no.

DENSO

100211-2400      100211-5450

**RN-08**

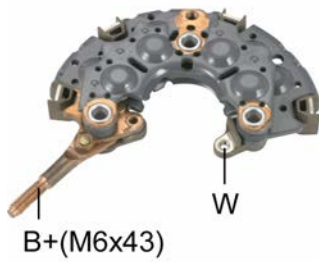

- \*113mm OD
- \*M6 Battery Post
- \*8-50 Amp Diodes
- \*Similar to RN-11
- \*With Mounting Hole for Ground Strap

Unit no.

DENSO

121000-4230      121000-4400      102211-0920

TOYOTA

27060-28160

**RN-10**

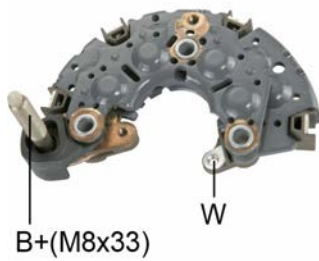

- \*113mm OD
- \*M8 Battery Post
- \*With Mounting Hole for Ground Strap
- \*8-50 Amp Diodes

**Replaces**

**DENSO :**

021580-4250      021580-4590

**HONDA :**

31127-PY3-0030

Unit no.

DENSO

100211-6160      100211-6170

HONDA

31100-PY3-003

**Used On**

**HYUNDAI**

Sonata 6Cyl. 3.3L

2007-

Sonata 6Cyl. 3.3L

2009-

**RN-11**

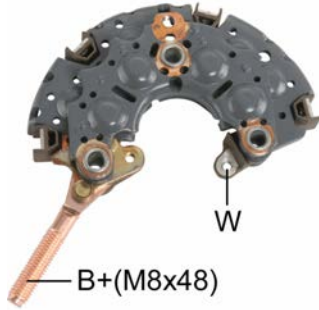

- \*113mm OD
- \*M8 Battery Post
- \*With Mounting Hole for Ground Strap
- \*8-50 Amp Diodes

**Replaces**

**DENSO :**

021580-3750	021580-3990	021580-4040	021580-4100	021580-4110	021580-4430
021580-4610	021580-4690	021580-5040			

**RN-12**

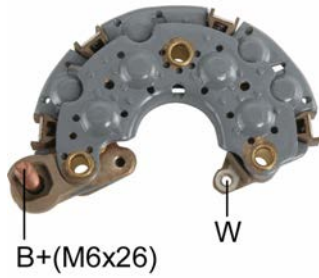

- \*100mm OD
- \*M6 Battery Post
- \*8-50 Amp Diodes

**Replaces**

**DENSO :**

021580-2511	021580-2512	021580-2510	021580-2521	021580-2522	021580-5060
-------------	-------------	-------------	-------------	-------------	-------------

**ISUZU :**

8-94125884-0

**TOYOTA :**

27357-70081

**Unit no.**

**DENSO**

0121000-2500	100211-1070	100211-7780	100211-7910	100211-7950	100211-7951
100211-7952	100211-7990	100211-9890	101211-0160		

**ISUZU**

8-97027-568-0

**RN-13**

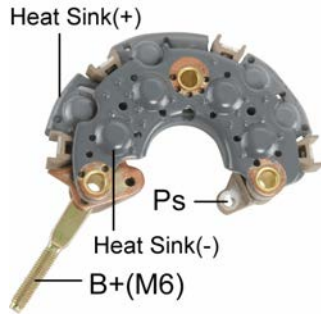

- \*100mm OD
- \*M6 Battery Post
- \*8-50 Amp Diodes

**Replaces**

**DENSO :**  
021580-2160      021580-2230

**TOYOTA :**  
27060-72010      27357-63020

**Unit no.**

DENSO					
100211-100	100211-1000	100211-1001	100211-1010	100211-1020	100211-1030
100211-104	100211-1040	100211-1041	100211-105	100211-1050	100211-1060
100211-108	100211-1080	100211-1081	100211-1090	100211-1091	100211-1170
100211-118	100211-1180	100211-1440	100211-200	100211-2000	100211-2001
100211-201	100211-2010	100211-2011	100211-202	100211-2020	100211-2021
100211-2030	100211-205	100211-2050	100211-206	100211-2060	100211-2061
100211-207	100211-2070	100211-210	100211-2100	100211-2102	100211-2140
100211-215	100211-2150	100211-217	100211-2170	100211-221	100211-2210
100211-2250	100211-250	100211-2500	100211-255	100211-2550	100211-3030
100211-3040	100211-3060	100211-3070	100211-3090	100211-3150	100211-3170
100211-3180	100211-3190	100211-3210	100211-3240	100211-3260	100211-3300
100211-3310	100211-3320	100211-3350	100211-3390	100211-3400	100211-3410
100211-3430	100211-3520	100211-3630	100211-3680	100211-7000	100211-7040
100211-7050	100211-7060	100211-7070	100211-7100	100211-7140	100211-7180
100211-7330	100211-7440	100211-7450	100211-7460	100211-7500	100211-7570
100211-7800	100211-7810	100211-7820	100211-7970	100211-8910	100211-9710
100211-9730	100211-9770	100211-9780	100211-9840	101211-0070	101211-0120
101211-0130	101211-0190	101211-0250	101211-0340	101211-0590	
HONDA					
31100-PD2-024	31100-PD6-014	31100-PH1-014	31100-PH3-0243	31100-PH5-0242	31100-PH7-004
31100-PH7-0040	31100-PH7-0240	31100-PJ0-0633	31100-PK1-004	31100-PK1-0147	31100-PK2-004
31100-PP8-0040	31100-PR3-0030	31100-PR5-0030	31100-PR6-0030		
ISUZU					
8-94131-357-2	8-94408-674-0				
TOYOTA					
27060-16010	27060-16012	27060-16080	27060-16122	27060-43060	27060-43111
27060-63020	27060-63080	27060-63082	27060-63100	27060-63102	27060-72010
27060-72050	27060-72060	27060-72061	27060-72070	27060-72071	27060-72100
27060-72101	27060-74010	27060-78001	27060-78300		

**RN-13PL**

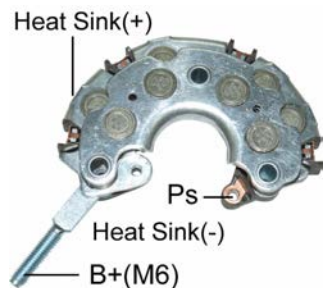

- \*100mm OD
- \*M6 Battery Post
- \*8-50 Amp Press-fit Diodes
- \*Aluminum Heat Sinks

**Replaces**

**DENSO :**

021580-2160      021580-2230

**TOYOTA :**

27060-72010      27357-63020

**Unit no.**

DENSO

100211-100	100211-1000	100211-1001	100211-1010	100211-1020	100211-1030
100211-104	100211-1040	100211-1041	100211-105	100211-1050	100211-1060
100211-108	100211-1080	100211-1081	100211-1090	100211-1091	100211-1170
100211-118	100211-1180	100211-1440	100211-200	100211-2000	100211-2001
100211-201	100211-2010	100211-2011	100211-202	100211-2020	100211-2021
100211-2030	100211-205	100211-2050	100211-206	100211-2060	100211-2061
100211-207	100211-2070	100211-210	100211-2100	100211-2102	100211-2140
100211-215	100211-2150	100211-217	100211-2170	100211-221	100211-2210
100211-2250	100211-250	100211-2500	100211-255	100211-2550	100211-3030
100211-3040	100211-3060	100211-3070	100211-3090	100211-3150	100211-3170
100211-3180	100211-3190	100211-3210	100211-3240	100211-3260	100211-3300
100211-3310	100211-3320	100211-3350	100211-3390	100211-3400	100211-3410
100211-3430	100211-3520	100211-3630	100211-3680	100211-7000	100211-7040
100211-7050	100211-7060	100211-7070	100211-7100	100211-7140	100211-7180
100211-7330	100211-7440	100211-7450	100211-7460	100211-7500	100211-7570
100211-7800	100211-7810	100211-7820	100211-7970	100211-8910	100211-9710
100211-9730	100211-9770	100211-9780	100211-9840	101211-0070	101211-0120
101211-0130	101211-0190	101211-0250	101211-0340	101211-0590	

HONDA

31100-PD2-024	31100-PD6-014	31100-PH1-014	31100-PH3-0243	31100-PH5-0242	31100-PH7-004
31100-PH7-0040	31100-PH7-0240	31100-PJ0-0633	31100-PK1-004	31100-PK1-0147	31100-PK2-004
31100-PP8-0040	31100-PR3-0030	31100-PR5-0030	31100-PR6-0030		

ISUZU

8-94131-357-2      8-94408-674-0

TOYOTA

27060-16010	27060-16012	27060-16080	27060-16122	27060-43060	27060-43111
27060-63020	27060-63080	27060-63082	27060-63100	27060-63102	27060-72010
27060-72050	27060-72060	27060-72061	27060-72070	27060-72071	27060-72100
27060-72101	27060-74010	27060-78001	27060-78300		

**RN-14**



\*100mm OD  
 \*M6 Battery Post  
 \*8-50 Amp Diodes

B+(M6x26)

**Replaces**

<b>DENSO :</b>			
021580-4120	021580-4490	021580-3680	021580-3640
<b>TOYOTA :</b>			
27357-74120	27357-74290		

**Unit no.**

<b>CHRYSLER</b>					
5233418	5233449	5233672			
<b>DENSO</b>					
0121000-2430	0121000-2680	0121000-3000	0121000-3300	0121000-3310	0121000-3370
0121000-3380	0121000-3390	0121000-3400	0121000-3450		

**RN-15**

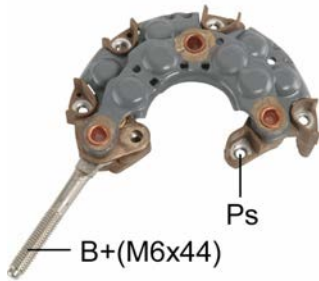

\*90mm OD  
 \*M6 Battery Post  
 \*8-50 Amp Diodes

B+(M6x44)

**Replaces**

<b>DENSO :</b>			
021580-3340	021580-4310	021580-4340	021580-3130
<b>TOYOTA :</b>			
27375-72150	27357-72120		

**Unit no.**

<b>DAIHATSU</b>					
27060-87706					
<b>DENSO</b>					
100211-1430	100211-1550	100211-1560	100211-1570	100211-1580	100211-1610
100211-3500	100211-4070	100211-4130	100211-4150	100211-4170	100211-4260
100211-4350	100211-4460	100211-4490	100211-6600	100211-6720	100211-6870
100211-6880	100211-6990	101211-2020	101211-2130		
<b>ISUZU</b>					
8-94449-781-1					

**RN-15PL**

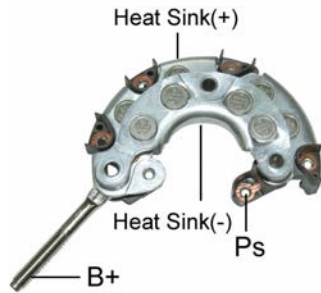

- \*90mm OD
- \*M6 Battery Post
- \*8-50 Amp Press-fit Diodes
- \*Aluminum Heat Sinks

**Replaces**

**DENSO :**  
021580-3130  
**TOYOTA :**  
27375-72150

**Unit no.**

DAIHATSU					
27060-87706					
DENSO					
100211-1430	100211-1550	100211-1560	100211-1570	100211-1580	100211-1610
100211-3500	100211-4070	100211-4130	100211-4150	100211-4170	100211-4260
100211-4350	100211-4460	100211-4490	100211-6600	100211-6720	100211-6870
100211-6880	100211-6990	101211-2020	101211-2130		
ISUZU					
8-94449-781-1					

**RN-16**

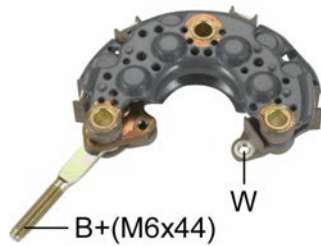

- \*90mm OD
- \*M6 Battery Post
- \*8-50 Amp diodes

**Replaces**

**DENSO :**  
021580-2250      021580-2260  
**TOYOTA :**  
27375-6340

**Unit no.**

DENSO					
100211-1200	100211-1210	100211-1230	100211-1260	100211-1270	100211-1310
100211-1320	100211-1340	100211-1350	100211-1360	100211-1370	100211-1380
100211-2170	100211-2210	100211-2250	100211-2280	100211-2330	100211-2370
100211-2380	100211-3220	100211-3500	100211-3510	100211-3530	100211-3540
100211-3550	100211-3590	100211-3610	100211-3660	100211-3690	100211-3770
100211-3820	100211-3890	100211-3960	100211-3970		
HONDA					
31100-PEO-003					
ISUZU					
8-94413-621-0					
TOYOTA					
27060-10011	27060-10060	27060-10061	27060-10090	27060-11010	27060-11050
27060-15040	27060-16091	27060-55020	27060-63041	27060-64020	27060-64021



**RN-16PL**

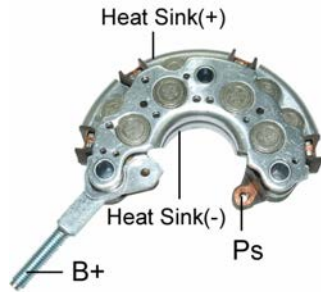

- \*90mm OD
- \*M6 Battery Post
- \*8-50 Amp Press-fit Diodes
- \*Aluminum Heat Sinks

**Replaces**

**DENSO :**  
021580-2250      021580-2260  
**TOYOTA :**  
27375-6340

**Unit no.**

DENSO					
100211-1200	100211-1210	100211-1230	100211-1260	100211-1270	100211-1310
100211-1320	100211-1340	100211-1350	100211-1360	100211-1370	100211-1380
100211-2170	100211-2210	100211-2250	100211-2280	100211-2330	100211-2370
100211-2380	100211-3220	100211-3500	100211-3510	100211-3530	100211-3540
100211-3550	100211-3590	100211-3610	100211-3660	100211-3690	100211-3770
100211-3820	100211-3890	100211-3960	100211-3970		
HONDA					
31100-PEO-003					
ISUZU					
8-94413-621-0					
TOYOTA					
27060-10011	27060-10060	27060-10061	27060-10090	27060-11010	27060-11050
27060-15040	27060-16091	27060-55020	27060-63041	27060-64020	27060-64021

**RN-17**

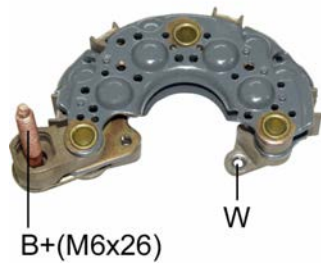

- \*90mm OD
- \*M6 Battery Post
- \*8-50 Amp Diodes

**Replaces**

**DENSO :**  
021580-2340      021580-2341      021580-2342  
**ISUZU :**  
16231-64851

**Unit no.**

DENSO		
100211-1200	100211-1330	100211-3720
ISUZU		
8-97137-345-2		

**RN-18**

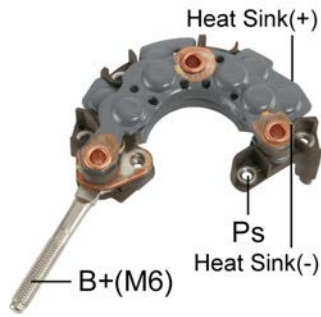

\*83mm OD  
 \*M6 Battery Post  
 \*8-35 Amp Diodes

**Replaces**

**DENSO :**  
 021580-3110

**Unit no.**

DENSO  
 100211-454      100211-4540

**RN-19**

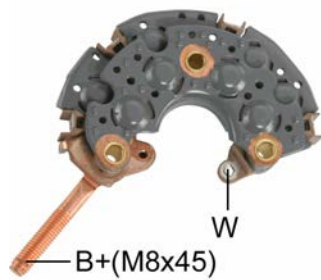

\*107mm OD  
 \*M8 Battery Post  
 \*8-50 Amp Diodes

**Replaces**

**DENSO :**  
 100211-1830      100211-2840

**Unit no.**

DENSO  
 100211-183      100211-1830      100211-2840  
 TOYOTA  
 27060-43100      27060-43130

**RN-20**

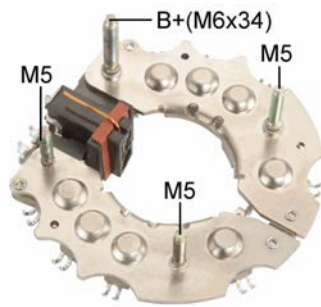

\*114mm OD  
 \*M5 Battery Post  
 \*8-35 Amp Diodes

**Replaces**

**DENSO :**  
 021600-1491      021600-1531      021600-1561

**TOYOTA :**  
 27362-15070      27362-43020

**Unit no.**

DENSO  
 100211-0530      100211-0550      100211-0560      100211-0590      100211-0630      100211-0650  
 100211-0660      100211-0670  
 TOYOTA  
 27060-15020      27060-28050      27060-43020      27060-43021      27060-43030      27060-43040

**RN-22**

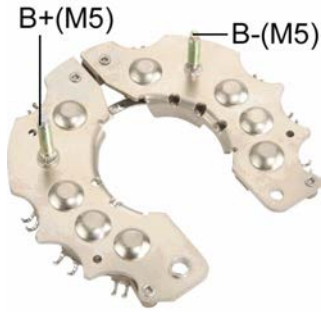

- \*114mm OD
- \*M5 Battery Post
- \*8-35 Amp Diodes
- \*Same as RN-20 but without Brush Holder

**Replaces**

<b>DENSO :</b>		
021600-1491	021600-1531	021600-1561
<b>TOYOTA :</b>		
27362-15070	27362-43020	

**Unit no.**

<b>DENSO</b>					
100211-0530	100211-0550	100211-0560	100211-0590	100211-0630	100211-0650
100211-0660	100211-0670				
<b>TOYOTA</b>					
27060-15020	27060-28050	27060-43020	27060-43021	27060-43030	27060-43040

**RN-24**

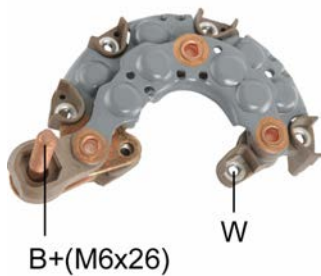

- \*90mm OD
- \*M6 Battery Post
- \*8-50 Amp Diodes

**Unit no.**

<b>DENSO</b>
100211-2460

**RN-26**



- \*83mm OD
- \*M6 Battery Post
- \*8-50 Amp Diodes

**Replaces**

<b>DENSO :</b>	
021580-3890	021580-3450

**Unit no.**

<b>DENSO</b>					
100211-1670	100211-4640	100211-4650	100211-4520	100211-4528	100211-4610
100211-4740	100211-4770	101211-1360			

**RN-29**

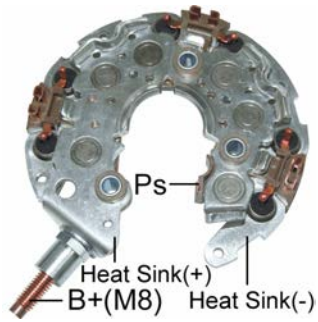

- \*117mm OD
- \*M8 Battery Post
- \*12-50 Amp Diodes

Unit no.

DENSO  
 421000-001      421000-002      421000-004      421000-006

**RN-30**

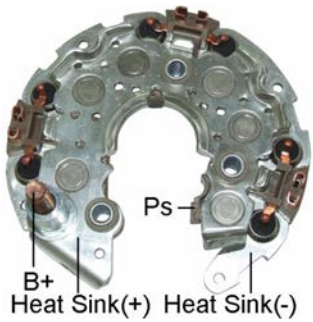

- \*117mm OD
- \*M8 Battery Post
- \*12-50 Amp Diodes

Unit no.

DENSO  
 4210000120

**RN-31**

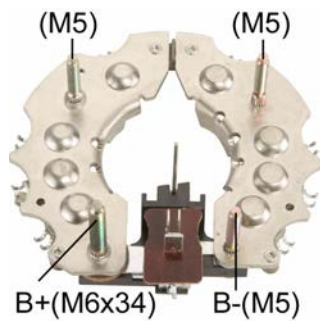

- \*113mm OD
- \*8-35 Amp Diodes

**Replaces**

**DENSO :**  
 021600-1840  
**TOYOTA :**  
 27362-63011

Unit no.

DENSO  
 021000-8270      021000-8310      021000-8311      021000-8340

**RN-32**

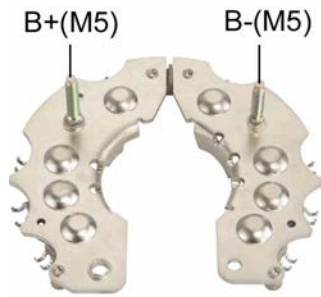

\*113mm OD  
\*6-35 Amp Diodes

**Replaces**

**DENSO :**

021600-0750      021600-1420      021600-1610

**Unit no.**

DENSO

0121000-1010	0121000-1011	0121000-1012	021000-6610	021000-6611	021000-6630
021000-6640	021000-6710	021000-8230	021000-8231		

**RN-33**

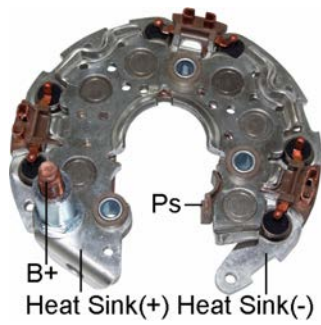

\*117mm OD  
\*M8 Battery Pos  
\*12-50A Avalanche Diodes

**Unit no.**

DENSO

10421-3090      104210-5950

FORD

9L3T-10300AB

**RN-34**

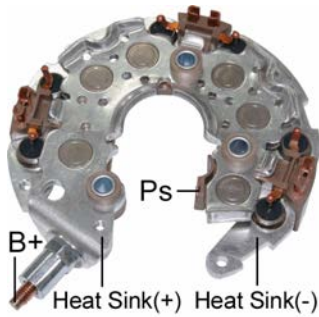

- \*117mm OD
- \*M6 Battery Post
- \*12-50A Avalanche Diodes

**Replaces**

**DENSO :**  
7060

**Unit no.**

DENSO					
104210-347	104210-420	104210-2360	104210-5370	104210-3750	104210-3751
9664219-375	104210-1000	10421-0338			
<b>HONDA</b>					
31100-RZP-G01	CSF37				
<b>TOYOTA</b>					
27060-0P020	27060-31020	27060-0V030	27060-OP240	27060-0F040	27060-75460

**Used On**

**TOYOTA**

Tacoma 6Cyl. 4.0L		2007-2013
Highlander 4Cyl. 2.4L		2007-
Highlander 4Cyl. 2.7L		2010-2013
Highlander 6Cyl. 3.3L		2007-
Sienna 3.3L		2005-2006

**RN-36**

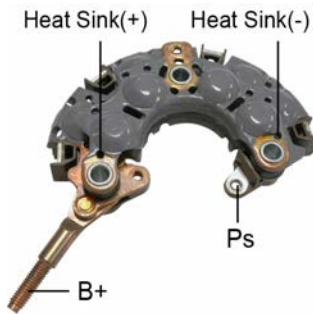

- \*107mm OD
- \*M6 Battery Post
- \*6-35A Avalanche Diodes
- \*With Mounting Hole for Ground Strap

**Replaces**

<b>DENSO :</b>		
021580-06510	021580-5510	021580-5560
<b>TOYOTA :</b>		
27357-22050	27357-22200	

**Unit no.**

DENSO					
102211-1920	102211-1990	102211-2380	102211-2480	104210-8181	104210-8590
<b>TOYOTA</b>					
27060-75490	27060-0H010	27060-21150	27060-22040	27060-22080	27060-28170

**Used On**

**TOYOTA**

Yaris	1.5L	2006-2009
Tacoma 4Cyl. 2.7L		2007-2010
Corolla 4Cyl. 1.8L		2003-2007

**RN-37**

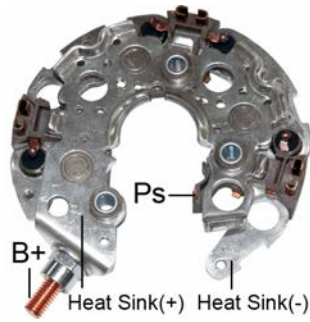

- \*117mm OD
- \*M8 Battery Post
- \*7-50A Avalanche Diodes

**Unit no.**

DENSO		
104210-3512	104210-3513	104210-3511
FORD		
3M5T-10300PD	3M5T-10300PC	

**Used On**

**FORD**

Fiesta V	(JH_,JD_)	1.6 TDCi 66kW	2004-
C-MAX		1.6 TDCi 80kW	2003-2007
Focus II	(DA_)	1.6 TDCi 80kW	2004-
Focus II	(DA_)	2.0 TDCi 100kW	2004-
Fusion	(JU_)	1.6 TDCi 66kW	2004-

**RN-38**

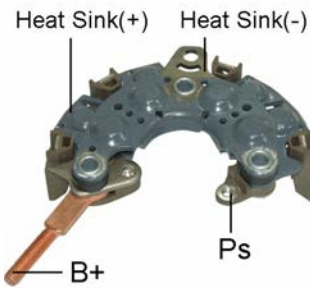

- \*100mm OD
- \*M6 Battery Post
- \*With Mounting Hole for Ground Strap
- \*8-50 Amp Diodes

**Replaces**

**DENSO :**  
021580-5300

**Unit no.**

DENSO					
102211-5013	102211-5022	102211-504	102211-5151	102211-5270	102211-5961
ISUZU					
29012-37800	29012-37801	89710-97800	89710-97801		
SUZUKI					
31400-77E22	31400-77E23				
TOYOTA					
27060-62190					

**Used On**

**SUZUKI**

Escudo	2.4	1996-1998
Sidekick	1.8L	1996-1998

**TOYOTA**

4-Runner	3.4L	1996-1998
4-Runner	2.7L	1996-1998
Tundra Pickup	3.4L	2000-2001

**RN-39**



- \*117mm OD
- \*M8 Battery Post
- \*12-50A (19-24V) Avalanche Diodes

Unit no.

DENSO

104210-3521      104210-3522      104210-3523

FORD

3M5T-10300YB    3M5T-10300YC    3M5T-10300YD

**RN-40**



- \*83mm OD
- \*M6 Battery Post
- \*8-50 Amp Diodes

Replaces

DENSO :

021580-3080      101211-1250

Unit no.

CHRYSLER

4609999AB      56041324

DENSO

100211-1680      121000-4250

TOYOTA

27060-0F020



**RN-41**

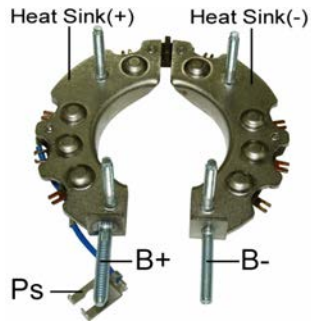

- \*114mm OD
- \*M6 Battery Post
- \*8-35 Amp Diodes

**Replaces**

**DENSO :**

021590-1890      021590-1900      021590-1910      021590-1950

**Unit no.**

**DENSO**

100211-1573      100211-2211      100211-2280      100211-2302      100211-2570      121000-0820

**Used On**

**HONDA**

Civic      1984-1987

**ISUZU**

TFR      1993-1993

**TOYOTA**

Celica 1.6GT      1986-1989

Land Cruiser      2.4D

**RN-41A**

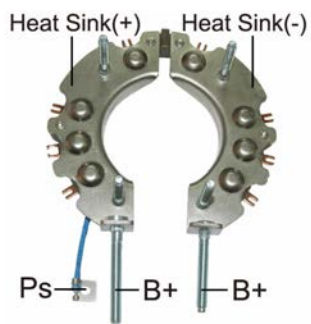

- \*114mm OD
- \*8-35 Amp Diodes

**Unit no.**

**DENSO**

100213-2560

**ISUZU**

8-97940-220-0

**RN-44**

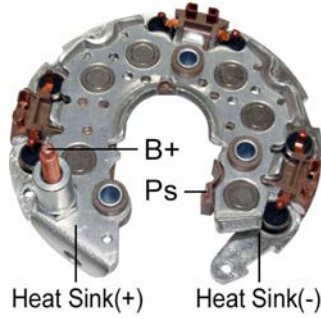

- \*117mm OD
- \*M6 Battery Post
- \*12-50A Avalanche Diodes

**Replaces**

**DENSO :**  
021580-5920

**Used On**

**GM**

Buick	3.8L	2004-2005
Cadillac	4.6L	2001-2002
Cadillac CTS	3.2L	2003-2004

**HONDA**

Accord 4Cyl. 2.4L		2008-2012
-------------------	--	-----------

**RN-45**

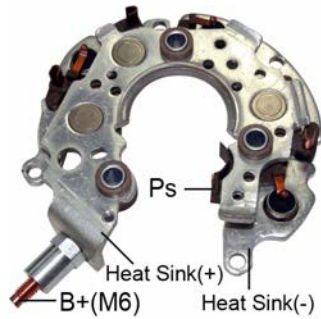

- \*105mm OD
- \*M6 Battery Post
- \*6-35A Avalanche Diodes

**Replaces**

**TOYOTA :**  
27060-0C021      27060-0C020

**Unit no.**

DENSO  
104210-9050  
TOYOTA  
27060-0H090

**Used On**

**TOYOTA**

INNOVA	2011-
KIJANG	2008-2011
Hilux	2008-2011
FORTUNER	2008-2011

**RN-45H**



- \*105mm OD
- \*M6 Battery Post
- \*6-50A Avalanche Diodes

**Unit no.**

DENSO  
104210-900  
TOYOTA  
27060-0C020

**Used On**

**TOYOTA**  
Fortuna

**RN-46**

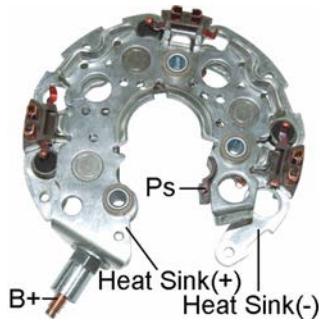

- \*117mm OD
- \*M6 Battery Post
- \*6-50A Avalanche Diodes

**Replaces**

**DENSO :**  
021580-6610

**Unit no.**

DENSO					
104210-388	104210-389	104210-533	104210-4471	104210-2341	104210-4470
104210-4880	104210-4881				
TOYOTA					
27060-0P140	27060-0P141	27060-0H100	27060-28270	27060-28350	27060-0V010

**Used On**

**TOYOTA**

Camary 4Cyl. 2.4L	2007-2010
Highlander 4Cyl. 2.4L	2007-
Solara 2.4L	2008-
Camry 6Cyl. 3.5L	2007-2013
RAV4 6Cyl. 3.5L	2009-2012
Tacoma 6Cyl. 4.0L	2007-2013
Highlander 6Cyl. 3.5L	2010-2012
Corolla 4Cyl. 1.8L	2011-2013
Corolla 4Cyl. 2.4L	2008-2011
Highlander 6Cyl. 3.3L	2007-
RAV4 4Cyl. 2.4L	2004-2008
RAV4 4Cyl. 2.5L	2008-
RAV4 4Cyl. 2.5L	2010-

**RN-47**

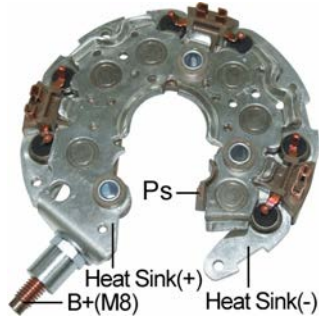

- \*117mm OD
- \*M8 Battery Post
- \*12-50A Avalanche Diodes

**Unit no.**

DENSO

104210-400      104210-448      104210-1240

HONDA

31100-RV0-A01    31100-R70-A01    31100-RCB-Y02    31100-RGL-A01    31100-RGW-A01

TOYOTA

27060-50340

**Used On**

**HONDA**

Accord 6Cyl. 3.5L      2007-2010

**TOYOTA**

Odyssey 6Cyl. 3.5L      2005-2010

**RN-48**

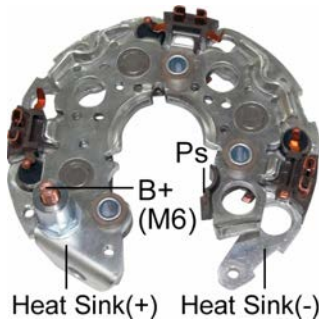

- \*117mm OD
- \*M6 Battery Post
- \*6-50A Avalanche Diodes

**Replaces**

**DENSO :**

021580-6490

**Unit no.**

DENSO

104210-3290      104210-3291      104210-3292      104210-3293

HONDA

31100-RAA-A01    31100-RAA-A03    31100-RAA-A04    31100-RAA-A05

**Used On**

**HONDA**

Accord 4Cyl. 2.4L      2007-

Element 2.4L      2003-2006

Civic 4Cyl. 2.0L      2006-2011

CRV 4Cyl. 2.4L      2007-2011

**RN-49**

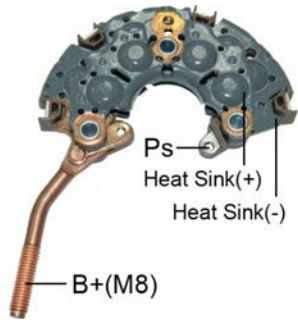

- \*113mm OD
- \*With Mounting Hole for Ground Strap
- \*8-50 Amp Diodes

**Replaces**

**DENSO :**  
021580-4890

**Unit no.**

DENSO					
100211-6300	101211-7090	101211-7091	101211-7800	102211-0730	
MAZDA					
KJ01-18-300	KJ01-18-300A				

**RN-50L**

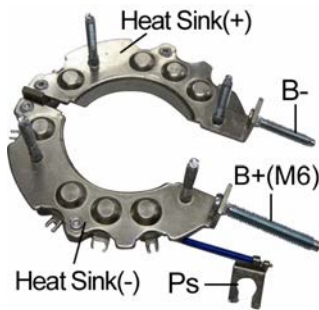

- \*114mm OD
- \*M6 Battery Post
- \*8-35A Avalanche Diodes
- \*Aluminum Heat Sinks

**Replaces**

**DENSO :**  
021590-2050      021590-1990

**Unit no.**

DENSO					
100213-0750	100213-0760	100213-0770	100213-0790	100213-0950	100213-0960

**RN-51**

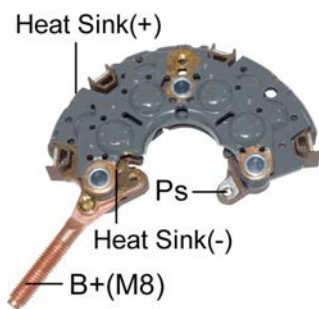

- \*113mm OD
- \*M8 Battery Post
- \*8-50A Avalanche Diodes
- \*With Mounting Hole for Ground Strap

**Replaces**

**DENSO :**  
021580-4780

**Unit no.**

DENSO  
100211-6420

**RN-53**

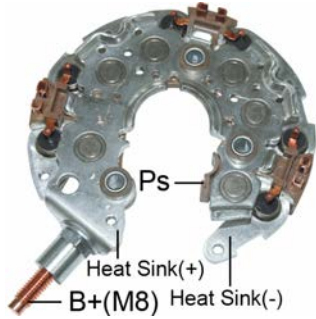

- \*117mm OD
- \*M8 Battery Post
- \*12-50A Avalanche Diodes

Unit no.

DENSO

421000-0410      421000-0470      421000-0530      421000-0540      421000-0541      421000-0542

421000-0560      421000-0700      421000-0810

TOYOTA

104210-2930

**RN-54**

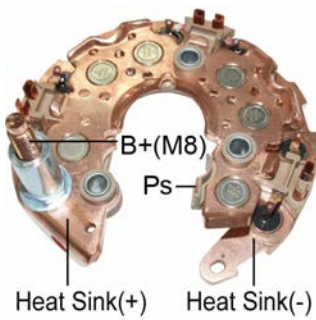

- \*117mm OD
- \*M8 Battery Post
- \*12-50A Avalanche Diodes

Replaces

DENSO :

03726

Unit no.

DENSO

104210-2160      104210-4220      104210-4370      104210-5640

GM

15139480      25755840      25862643

HYUNDAI

37300-3C200

**RN-55**

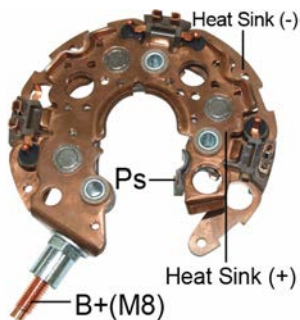

- \*117mm OD
- \*M8 Battery Post
- \*7-50 Amp Diodes

Unit no.

CHRYSLER

04606755AC      04868431AF      04868431AG      4606755AC      4868431AF      4868431AG

56028697AA

DENSO

421000-0210      421000-0222      421000-0223      421000-0225      421000-0230

**RN-56**

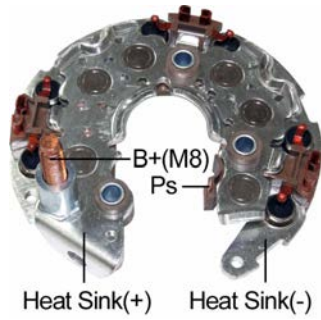

- \*117mm OD
- \*M8 Battery Post
- \*12-50A Avalanche Diodes

**Unit no.**

CHRYSLER

56029915AB      56044380AH

DENSO

421000-0150      421000-0260      421000-0261      421000-0343      421000-0344      421000-0360

421000-0552

**RN-57**

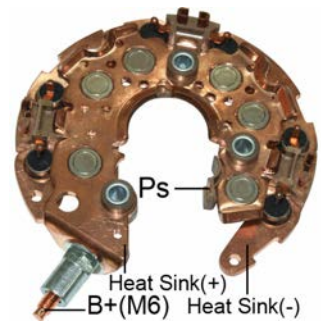

- \*117mm OD
- \*M6 Battery Post
- \*12-50A Avalanche Diodes

**Replaces**

**DENSO :**

021580-5941

**Unit no.**

DENSO

104210-4090      104210-4091      104210-3450      9664219-345

FORD

5F9T-10300BB      5F9Z-10346BA

TOYOTA

27060-0A110

**Used On**

**TOYOTA**

Highlander 6Cyl. 3.5L

2010-2013

RAV4 6Cyl. 3.5L

2006-2012

Sienna 3.3L

2005-2007

Sienna 3.5L

2005-2012

**RN-59**

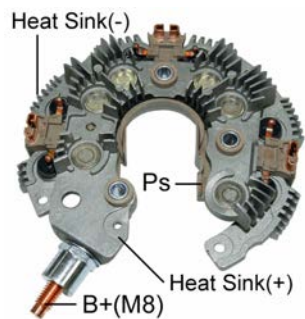

- \*134mm OD
- \*M8 Battery Post
- \*12-50A Avalanche Diodes

**Replaces**

DENSO :  
785

**Unit no.**

DENSO  
104210-6140  
TOYOTA  
27060-38050

**Used On**

**LEXUS**

LX570 5.7L 2008-2011

**TOYOTA**

Land Cruiser 5.7L 2008-2010

Sequoia 4.6L 2010-2012

Sequoia 5.7L 2008-2012

**RN-60**

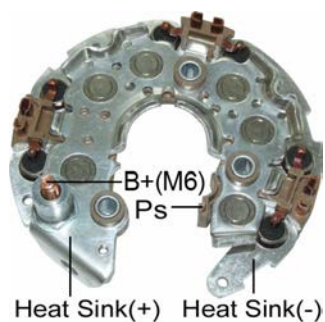

- \*117mm OD
- \*M6 Battery Post
- \*12-50A Avalanche Diodes

**Unit no.**

DENSO  
104210-589  
HONDA  
31100-R40-A01



**RN-63**

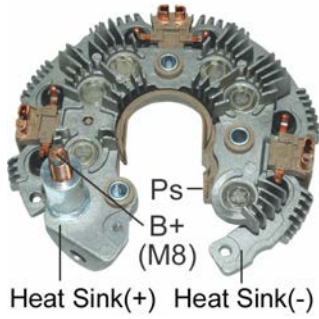

- \*134mm OD
- \*M8 Battery Post
- \*12-50A Avalanche Diodes

**Unit no.**

DENSO					
104210-6101	104210-600	104210-611	104210-6010	104210-6110	4801778AF
P04801778AF					
FORD					
7C3T-10300EE					
GM					
15817893	15868747				
SUZUKI					
31400-78J10					

**RN-64**

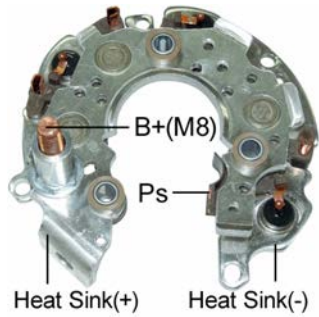

- \*105mm OD
- \*M8 Battery Post
- \*6-50A Avalanche Diodes

**Unit no.**

DENSO	
104210-9031	104210-2341
TOYOTA	
8973697161	

**Used On**

<b>TOYOTA</b>	
Camry 4Cyl. 2.5L	2012-2013
RAV4 4Cyl. 2.5L	2009-2012

**RN-66**

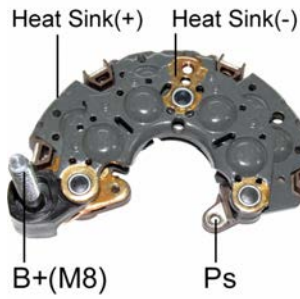

- \*113mm OD
- \*M8 Battery Post
- \*With Mounting Hole for Ground Strap
- \*8-50 A Avalanche Diodes

Unit no.

HYUNDAI  
37300-3C170  
POONG SUNG  
02131-9330

Used On

<b>HYUNDAI</b>	
Entourage 3.8L	2007-2008
<b>KIA</b>	
Sedona 3.8L	2007-2008

**RN-67**



- \*134mm OD
- \*M8 Battery Post
- \*12-50A Avalanche Diodes

Unit no.

DENSO					
104210-6340	104210-6180	104210-6182	104210-6181	104210-6270	104210-6670
104210-6220	104210-6080				

Used On

<b>FORD</b>	
F150 3.7L	2011-

**RN-69**

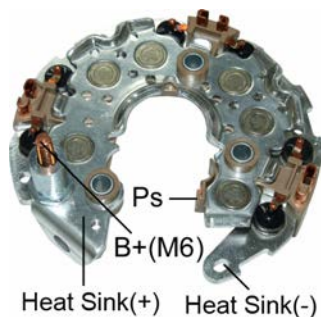

- \*117mm OD
- \*M6 Battery Post
- \*12-50A Avalanche Diodes

Unit no.

DENSO

104210-1530

HONDA

31100-RTA-003    31100-RTA-013    31100-RTA-023    31100-RWC-A01    31100-RX0-A01RM

Used On

**HONDA**

Accord 2.4L	2003-2005
Accord 2000 16V	2002-2008
Accord 2400 16V	2002-2008
Civic 2000	2007-2012
Element 2.4L	2003-2006

**RN-70**

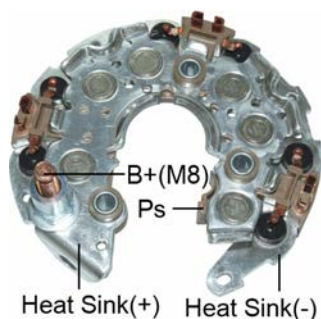

- \*117mm OD
- \*M8 Battery Post
- \*12-50A Avalanche Diodes

Unit no.

DENSO

104210-3970    104210-3971    104210-2460

HONDA

31100-RFE-0130    31100-RFE-003

Used On

**HONDA**

Odyssey	2005-2008
---------	-----------

**RN-71**

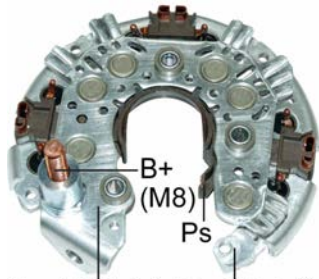

- \*132mm OD
- \*M8 Battery Post
- \*12-50A Avalanche Diodes

Unit no.   
 DENSO  
 421000-7040

**Used On**

<b>CHRYSLER</b>	
300 V6 3.6L	2011-2014
<b>DODGE</b>	
Charger V6 3.6L	2011-2013
Durango V6 3.6L	2011-2014
<b>JEEP</b>	
Grand Cherokee V6 3.6L	2011-2014

**RN-72**

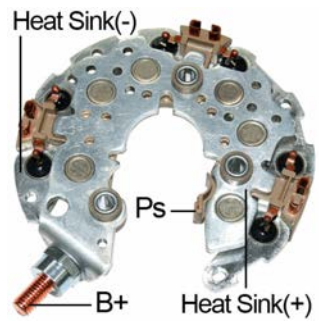

- \*117mm OD
- \*M8 Battery Post
- \*12-50A Avalanche Diodes

Unit no.   
 DENSO  
 104210-8850  
 FORD  
 D2BT-10300AA

**RN-74**

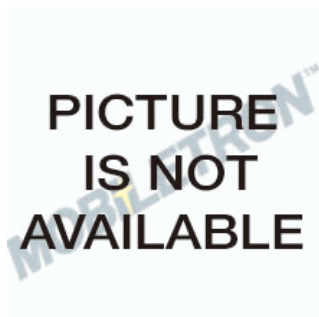

Unit no.   
 DENSO  
 104210-73301    104210-6250    104210-6040

**Used On**

<b>BMW</b>	
X3	2003-2010
X5	2006-2013

**RN-76**

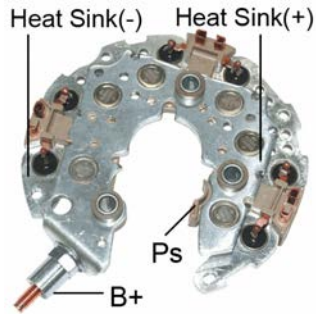

\*117mm OD  
\*12-50 Amp Diodes

Unit no.

DENSO

104211-3200

104211-3201

104211-3202

104211-3010

104211-3000

104210-1350

104210-1351

**RI-07H**

\*6-35 Amp Diodes  
\*110mm OD



**Replaces**

**BOSCH :**  
9-121-337-337

**FEMSA :**  
28466-6

**LUCAS :**  
UBB600

**TOSHIBA :**  
7G2                      7H4

**Unit no.**

BOSCH					
9-120-330-227	9-120-330-292	9-120-330-502	9-120-330-505	9-120-330-506	9-120-330-522
9-120-330-533	9-120-335-217				
FEMSA					
ALB12117	ALB30X92	ALB4077	ALE242	ALE2422	ALE2423
ALE245	ALE246				

**RI-08H**

\*6-35 Amp Diodes  
\*110mm OD



**Replaces**

**BOSCH :**  
9-121-337-324

**FEMSA :**  
25945-9

**TOSHIBA :**  
7M2

**Unit no.**

BOSCH					
9-120-331-802	9-120-331-805	9-120-331-806	9-120-331-814	9-120-331-819	9-120-331-820
9-120-331-855					
FEMSA					
ALS12N14	ALS12N55	ALS24N20	ALS24N5	ALS24NX19	ALS24NX2
ALS24NX6					
FIAT					
4376376	4474933				
MAGNETI MARELLI					
63303213	63303780				

**RI-09H**

\*6-35 Amp Diodes  
\*110mm OD



**Replaces**

**BOSCH :**  
9-121-337-323

**FEMSA :**  
25945-8

**Unit no.**

BOSCH  
9-120-331-847

FEMSA  
ALS12N47

**RF-01**

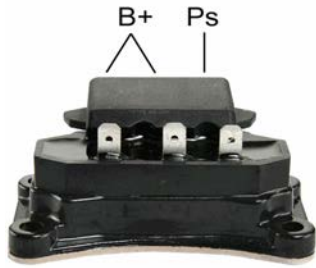

- \*6-25 Amp Diodes
- \*FORD 2G series 75-80 AMP IR/EF Alternators
- \*40-65A Internally Regulated Alternators

**Replaces**

**FORD :**  
E43Z-10304A      E43Z-10335A  
**MOTORCRAFT :**  
GY-1351

**RF-02**

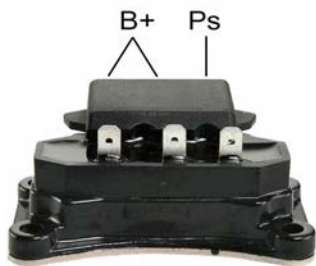

- \*6-35 Amp Diodes
- \*Copper Heat Sink
- \*FORD 2G series 75-80 AMP IR/EF Alternators

**Replaces**

**FORD :**  
E6DZ-10304      E6DZ-10304A  
**MOTORCRAFT :**  
GY-1360

**RF-03**

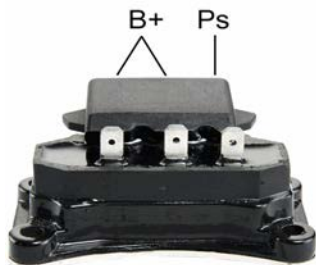

- \*6-50 Amp Diodes
- \*Copper Heat Sink



**RF-043**

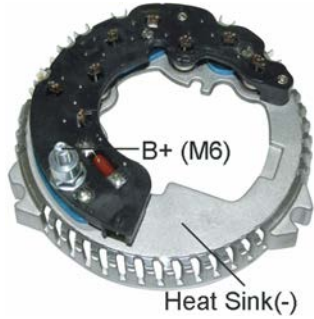

- \*8-35 Amp Diodes
- \*133mm OD
- \*W/Drop Down Leads
- \*Ford 3G Series 75-95 Amp IR/IF Alternators

**Replaces**

**FORD :**  
F5AZ-10304BA

**Unit no.**

FORD  
 98AB-10300EB    98AZ-10346EA    98BB-10300CC    A8ZU-10300AC    F8AU-10300AC    F8RZ-10346CC  
 GL456            XS8Z-10346BB    XS8Z-10346BBRM    XS91-10300BB    XS91-10300BC

**RF-043HV**



- \*8-70 Amp Diodes
- \*133mm OD
- \*W/Drop Down Leads
- \*Ford 3G Series 75-95 Amp IR/IF Alternators

**RF-053**

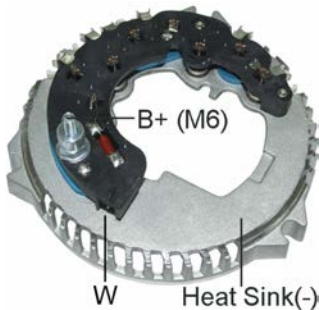

- \*8-50 Amp Diodes
- \*147mm OD
- \*W/Drop Down Leads
- \*Ford 3G Series 115-130 Amp IR/IF Alternators

**Replaces**

**FORD :**  
F5AZ-10304AA    FODU-10A366DAIP

**Unit no.**

FORD  
 94BB-10300AE    96BB-10300AB    97BB-10300AC    F0DF-10300BA    F0DU-10300BC    F0DZ-10346B  
 F0DZ-10346C    F0DZ-10346E    F1DU-10300AD    F1DZ-10346A    F1DZ-10346B    F2TU-10300AF  
 F2UU-10300BE    F2UU-10300DC    F2UU-10300FA    F37U-10300AA    F3AU-10300AC    F3AU-10300BA  
 F3AU-10300CA    F3DU-10300BB    F4DU-10300AA    F4DU-10300BA    F4DU-10300CA    F4DU-10300DA  
 F4PU-10300AA    F4PU-10346BA    F4PU-10346DA    F4PZ-10346BRM    F4PZ-10346D    F4PZ-10346DRM  
 F4SU-10300AB    F4ZU-10300DA    F58U-10300AB    F5AU-10300AA    F5PU-10346CA    F5PU-10346PA  
 F5PZ-10346PA    F5PZ-10346PARM    F5RU-10300BA    F5UU-10300AA    F5UU-10300BA    F65U-10300BB  
 F6AU-10300AA    F6PU-10300AA    F6PZ-10346B    F75U-10300CA    F8ZU-10300BA    XU2U-10346AA  
 XU2Z-10346AA

**RF-053HV**

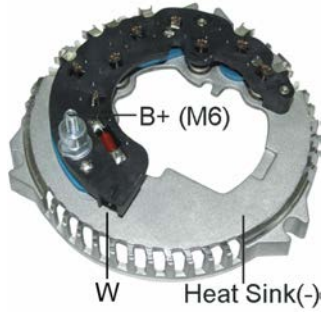

- \*8-70A Avalanche Diodes
- \*147mm OD
- \*W/Drop Down Leads
- \*Ford 3G Series 115-130 Amp IR/IF Alternators

**Replaces**

**FORD :**  
F5AZ-10304AA

**Unit no.**

FORD  
F0DF-10300BA    F0DU-10300BC    F0DZ-10346B    F0DZ-10346C    F0DZ-10346E    F2UU-10300BE

**RF-063**

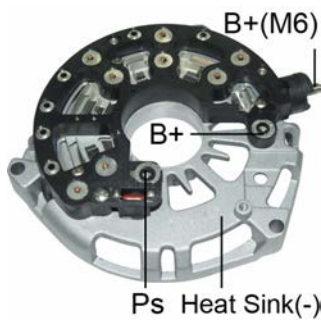

- \*133mm OD
- \*8-50 Amp Diodes
- \*W/Drop Down Leads
- \*Ford 4G Series IR/IF Alternators

**Replaces**

**FORD :**  
F5OZ-10300FA    F6DU-10300BB    F6LU-10300CA    F6OU-10300AA    F6ZU-10300BB    139668

**MOTORCRAFT :**  
GL-331

**Unit no.**

FORD  
F50U-10300FC    F5DU-10300DB    F5OU-10300FA    F5OU-10300GS    F60U-10300AA    F60U-10300AB  
F60Y-10346AA    F68U-10300AD    F68U-10300AF    F68U-10300AS    F6DU-10300BB    F6DU-10300BD  
F6DU-10300DB    F6DU-10300DC    F6DU-10300DD    F6DZ-10346B    F6DZ-10346BRM    F6DZ-10346D  
F6DZ-10346DRM    F6LU-10300CA    F6LU-10300CB    F6LU-10300CC    F6LU-10300CD    F6LU-10346A  
F6LY-10346A    F6OU-10300AA    F6ZU-10300BB    F6ZU-10300BC    F6ZU-10300BE    F6ZU-10300BF  
F6ZU-10300BG    F6ZZ-10346B    F6ZZ-10346BRM    F77U-10300AB    F77U-10300AC    F77Z-10346AB  
F77Z-10346ABRM    F78U-10300AA    F78Z-10346AA    F78Z-10346AARM    F80U-10300CA    F80U-10300CB  
F80Z-10346CA    XF2Z-10346AA    XL2U-10300AA    XL2Z-10346AA    XL2Z-10346AARM    XL3U-10300AA  
XL3U-10300AB    XL3Z-10346AA    XW7U-10300AA    XW7U-10300AD    XW7Z-10346AA    XW7Z-10346AARM

**RF-063HV**

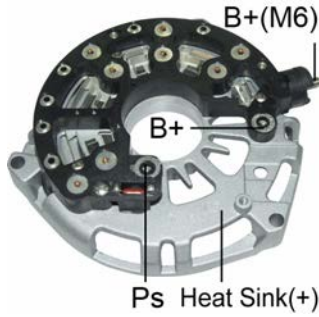

- \*133mm OD
- \*8-70A Avalanche Diodes
- \*W/Drop Down Leads
- \*Ford 4G Series IR/IF Alternators

Unit no.

FORD

F50U-10300FC	F5DU-10300DB	F5OU-10300FA	F5OU-10300GS	F60U-10300AA	F60U-10300AB
F60Y-10346AA	F68U-10300AD	F68U-10300AF	F68U-10300AS	F6DU-10300BB	F6DU-10300BD
F6DU-10300DB	F6DU-10300DC	F6DU-10300DD	F6DZ-10346B	F6DZ-10346BRM	F6DZ-10346D
F6DZ-10346DRM	F6LU-10300CA	F6LU-10300CB	F6LU-10300CC	F6LU-10300CD	F6LU-10346A
F6LY-10346A	F6OU-10300AA	F6ZU-10300BB	F6ZU-10300BC	F6ZU-10300BE	F6ZU-10300BF
F6ZU-10300BG	F6ZZ-10346B	F6ZZ-10346BRM	F77U-10300AB	F77U-10300AC	F77Z-10346AB
F77Z-10346ABRM	F78U-10300AA	F78Z-10346AA	F78Z-10346AARM	F80U-10300CA	F80U-10300CB
F80Z-10346CA	XF2Z-10346AA	XL2U-10300AA	XL2Z-10346AA	XL2Z-10346AARM	XL3U-10300AA
XL3U-10300AB	XL3Z-10346AA	XW7U-10300AA	XW7U-10300AD	XW7Z-10346AA	XW7Z-10346AARM

**RF-07H**



- \*6-35 Amp Diodes
- \*Ford 1G Series ER/EF Alternators

Replaces

FORD :

D6AZ10304A      D9VY10304A      GY1306A

Unit no.

FORD

GY1306A

**RF-07HV**



- \*6-50 Amp Diodes
- \*Ford 1G Series ER/EF Alternators

Replaces

MOTORCRAFT :

GY-1306A

**RF-08H**

\*6-35 Amp Diodes  
 \*Ford 1G Series ER/EF Alternators



**Replaces**

**DELCO :**  
 A3900

**FORD :**  
 D6AZ-10304A     D9VY-10304A

**MOTORCRAFT :**  
 GY-1306A         GY-1327

**RF-08HV**

\*6-70 Amp Diodes  
 \*Ford 1G Series ER/EF Alternators



**Replaces**

**DELCO :**  
 A3900

**FORD :**  
 D6AZ-10304A

**MOTORCRAFT :**  
 GY-1306A

**Unit no.**

DELCO  
 A3900

FORD  
 D64Z-10304A     D9VY-10304A

MOTORCRAFT  
 GY-1306A         GY-1327

**RF-09H**

\*6-35 Amp Diodes  
 \*Ford 1G Series 70 Amp ER/EF Alternators



**Replaces**

**FORD :**  
 D2OZ-10304A  
**MOTORCRAFT :**  
 GY-1026

**Unit no.**

FORD  
 GL215

**RF-09HV**

\*6-50 Amp Diodes  
 \*Ford 1G Series 70 Amp ER/EF Alternators



**Replaces**

**FORD :**  
 D2OZ-10304A    F0TZ-10304A    GY-1026-A  
**MOTORCRAFT :**  
 GY-1026A

**Unit no.**

FORD  
 D9AF-10300CA    E3TF-10300AB    E4LF-10300CA    E6DF-10300CA    E9TF-10300AA    F0TU-10300AA

**RF-103**

\*136mm OD  
 \*8-50 Amp Diodes  
 \*W/Drop Down Leads  
 \*Ford 6G Series 105 Amp IR/IF Alternators

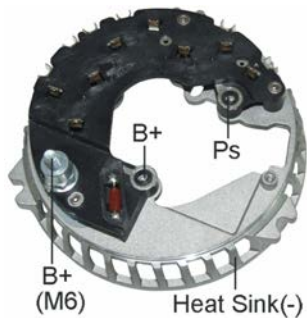

**Replaces**

**FORD :**  
 F8WU10A366AAIP    F8WU10A366AA    F8WU10A336AA1P

**Unit no.**

FORD  
 1S41-10300BB    4C3Z-10346AA    98AB-10300FC    98AZ-10346FA    F81U-10300BA    F81U-10300BC  
 F81U-10300CC    F81U-10300CD    F81U-10300DB    F81U-10300DC    F81U-10300DD    F81U-10300EB  
 F81U-10300GA    F81Z-10346BA    F81Z-10346CA    F81Z-10346DA    F81Z-10346EA    F81Z-10346GA  
 F8WU-10A366AA    XF2U-10300AB    XF2Z-10346AARM    XR3U-10300AA    XR3U-10300AB    XR3U-10300AC  
 XR3Z-10346AA    XR3Z-10346AARM    ZR3U-10300AB

**RF-103HV**

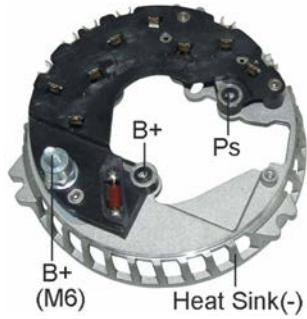

- \*136mm OD
- \*8-70A Avalanche Diodes
- \*W/Drop Down Leads
- \*Ford 6G Series 105 Amp IR/IF Alternators

**Replaces**

**FORD :**  
F8WU-10A366AAIP

**Unit no.**

FORD

1S41-10300BB	4C3Z-10346AA	98AB-10300FC	98AZ-10346FA	F81U-10300BA	F81U-10300BC
F81U-10300CC	F81U-10300CD	F81U-10300DB	F81U-10300DC	F81U-10300DD	F81U-10300EB
F81U-10300GA	F81Z-10346BA	F81Z-10346CA	F81Z-10346DA	F81Z-10346EA	F81Z-10346GA
F8WU-10A366AA	XF2U-10300AB	XF2Z-10346AARM	XR3U-10300AA	XR3U-10300AB	XR3U1-0300AC
XR3Z-10346AA	XR3Z-10346AARM	ZR3U-10300AB			

**RF-113**

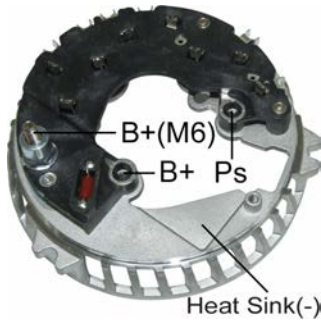

- \*136mm OD
- \*8-50 Amp Diodes
- \*W/Drop Down Leads
- \*Ford 6G Series IR/IF Alternators

**Replaces**

**FORD :**  
233208

**Unit no.**

FORD

98AB-10300EB	98AZ-10346EA	98BB-10300CC	A8ZU-10300AC	F8AU-10300AC	F8RZ-10346CC
GL456	XS8Z-10346BB	XS8Z-10346BBRM	XS91-10300BB	XS91-10300BC	

**RF-123**

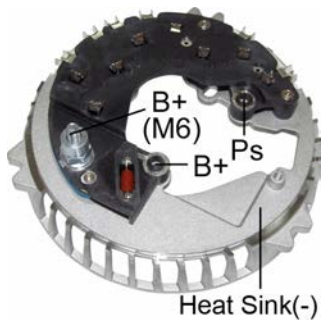

- \*149mm OD
- \*8-50 Amp Diodes
- \*W/Drop Down Leads
- \*Ford 6G Series IR/IF Alternators

**Replaces**

**FORD :**  
F8AU10A366AA F8AU10A366AAIP

**Unit no.**

FORD

3W1U-10300BB	3W1Z-10346BARM	F8AU-10300AB	F8AU-10300AD	F8AZ-10346AB	F8AZ-10346ABRM
F8ZU-10300AC	XF2U-10300BC	XF2U-10300BD	XF2Z-10346BA	XF2Z-10346BARM	

**RF-123HV**

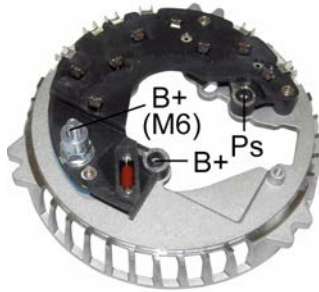

- \*149mm OD
- \*8-70A Avalanche Diodes
- \*W/Drop Down Leads
- \*Ford 6G Series IR/IF Alternators

**Replaces**

FORD :  
F8AU-10A366AAIP

Unit no.

FORD  
 3W1U-10300BB    3W1Z-10346BARM    F8AU-10300AB    F8AU-10300AD    F8AZ-10346AB    F8AZ-10346ABRM  
 F8ZU-10300AC    XF2U-10300BC    XF2U-10300BD    XF2Z-10346BA    XF2Z-10346BARM

**RF-124**

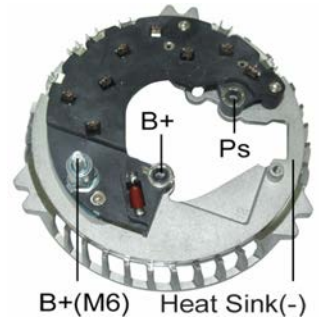

- \*149mm OD
- \*8-50 Amp Diodes
- \*Ford 6G Series 135-140 Amp IR/IF Alternators

Unit no.

FORD  
 5C3T-10300BA    5C3Z-10346BA    6C3T-10300BA    6C3Z-10346BA

**RF-125**

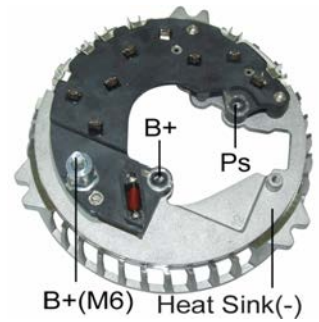

- \*149mm OD
- \*8-50A Avalanche Diodes
- \*Ford 6G Series IR/IF Alternators

Unit no.

FORD  
 3L74-10300AA    3L74-10300BA    3L74-10300BB    3L74-10346AA    3L7Z-10346AA    3L7Z-10346BA  
 6F2Z-10346BA

**RF-133**

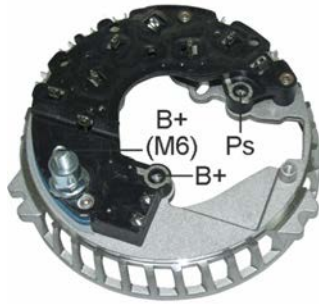

- \*\*Replace RF-13
- \*131mm OD
- \*M6 Battery Post
- \*6-50 Amp Diodes
- \*W/Drop Down Leads

Unit no.

FORD

1L8U-10300CE	1L8Z-10346CB	GL453	GL463	GL466	XS8Z-10346AA
XS91-10300AE	XW4U-10300AA	XW4U-10300AB	XW4U-10300BA	XW4U-10300BB	XW4Z-10346AA
XW4Z-10346BA	YF1U-10300FA	YF1U-10300FB	YF1Z-10346FA		

**RF-143**

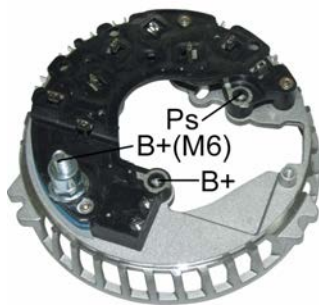

- \*\*Replace RF-14
- \*131mm OD
- \*M6 Battery Post
- \*6-50 Amp Diodes
- \*W/Drop Down Leads

Unit no.

FORD

1L8Z-10346CB

**RF-153**

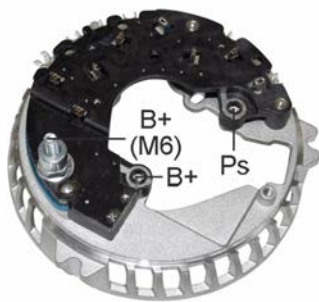

- \*131mm OD
- \*M6 Battery Post
- \*6-50 Amp Diodes
- \*W/Drop Down Leads
- \*Ford 6G Series IR/IF Alternators

Unit no.

FORD

1L8Z-10346AB



**RF-16HD**

\*6-70 Amp Diodes



**Replaces**

**FORD :**  
 D3VY-10304A    E9DZ-10304A    F0HZ-10304A  
**MOTORCRAFT :**  
 GY-1302        GY-1302B        GY-1345A        GY-1346

**RF-16HV**

\*6-50 Amp Diodes



**Replaces**

**FORD :**  
 D3VY-10304A    E9DZ-10304A    F0HZ-10304A  
**MOTORCRAFT :**  
 GY-1302        GY-1302B        GY-1345A        GY-1346

**RF-18HV**

\*8-50A Avalanche Diodes  
 \*M6 Battery Post

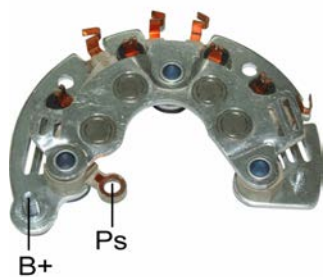

**Unit no.**

**FORD**  
 1S7T-10300BA    1S7T-10300BB    1S7T-10300BC    1S7T-10300DB    1S7T-10300DC

**RF-19H**

\*M6 Battery Post  
\*8-50 Amp Diodes

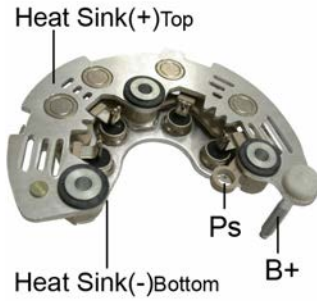

Unit no.

FORD  
CX1FA  
VALEO  
3N2110300BB

**RF-22HV**

\*105mm OD  
\*M6 Battery Post  
\*8-50A Avalanche Diodes

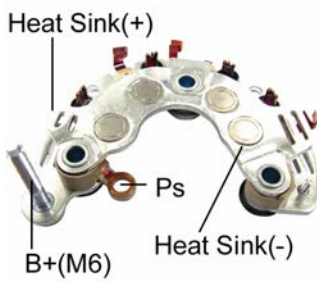

Unit no.

FORD  
2S6T-10300FA 2S6T-10300FB  
VISTEON  
20-150-01001

**RF-23W**

\*6-50 Amp Diodes  
\*FORD 2G Series 40-80A IR/EF Alternators

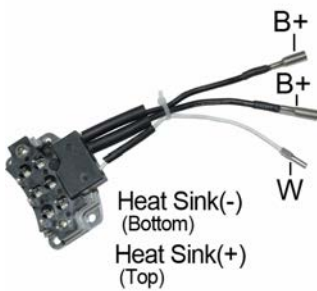

Replaces

FORD :  
E43Z-10304A E6DZ-10304A E6DZ10304 GY1351 GY1360

**RH-01**

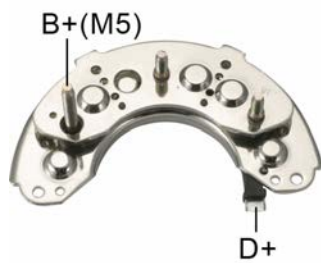

- \*118mm OD
- \*Aluminum Heat Sink
- \*M5 Battery Post w/diode Trio
- \*6-35 Amp Diodes

**Replaces**

**HITACHI :**

L150-13203      L160-3320

**NISSAN :**

23230-06500      23230-Q4601

**SUBARU :**

49534-7101

**Unit no.**

**HITACHI**

LR155-15C	LR160-104	LR160-105	LR160-109	LR160-110	LR160-116
LR160-117	LR160-130	LR160-133	LR160-78	LR160-78B	LR160-82
LR160-82B	LR160-84	LR160-84B	LR160-93	LR170-14	LR170-18
LT150-113	LT150-114	LT150-123			

**NISSAN**

23100-29R00	23100-D0201	23100-D0800	23100-D1700	23100-D3300	23100-H7205
23100-V0101	23100-V0102	23100-V0106	23100-V0107	23100-W5806	23100-W5807

**SUBARU**

23700-AA00Q	23700-AA020	23700-AA160	42990-7000	42990-7010	42990-7300
42990-7320	42990-7330	42990-7340	42990-7400	42990-7500	42990-7600
42990-7700					

**RH-01C**

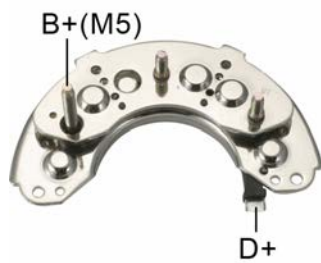

- \*118mm OD
- \*Copper Heat Sinks
- \*M5 Battery Post w/diode Trio
- \*6-35 Amp Diodes

**Replaces**

**HITACHI :**  
L150-13203            L160-3320

**NISSAN :**  
23230-06500            23230-Q4601

**SUBARU :**  
49534-7101

**Unit no.**

HITACHI					
LR155-15C	LR160-104	LR160-105	LR160-109	LR160-110	LR160-116
LR160-117	LR160-130	LR160-133	LR160-78	LR160-78B	LR160-82
LR160-82B	LR160-84	LR160-84B	LR160-93	LR170-14	LR170-18
LT150-113	LT150-114	LT150-123			
NISSAN					
23100-29R00	23100-D0201	23100-D0800	23100-D1700	23100-D3300	23100-H7205
23100-V0101	23100-V0102	23100-V0106	23100-V0107	23100-W5806	23100-W5807
SUBARU					
23700-AA00Q	23700-AA020	23700-AA160	42990-7000	42990-7010	42990-7300
42990-7320	42990-7330	42990-7340	42990-7400	42990-7500	42990-7600
42990-7700					

**RH-02**

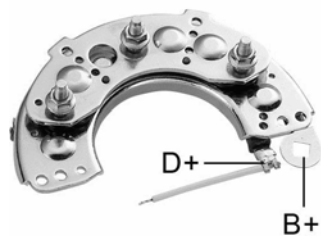

- \*111mm OD
- \*Aluminum Heat Sink
- \*M5 Battery Post w/diode Trio
- \*6-35 Amp Diodes

**Replaces**

**HITACHI :**  
L150-13204

**ISUZU :**  
8-94237-729-0

**NISSAN :**  
23232-W1700

**Unit no.**

HITACHI					
LR150-117C	LR150-133B	LR150-133E	LR150-136E	LR150-147C	LR150-148C
LR150-155B	LR150-157B	LR150-158	LR150-165	LR150-201B	LR150-202
LR150-203	LR150-205B	LR150-206	LR150-211B	LR150-212B	LR150-79H
LR155-16B					
ISUZU					
5-81200-316-3	8-94111-836-0	8-94122-220-1	8-94169-952-0	8-94170-993-0	8-94241-630-2
8-94244-298-2	8-94401-793-2	8-94404-636-0	8-94405-044-2	8-94411-907-2	8-94411-908-2
NISSAN					
23099-34W01	23099-36W01	23099-36W02	23099-36W04	23100-17S00	23100-G3701
23100-W1802					

**RH-02C**

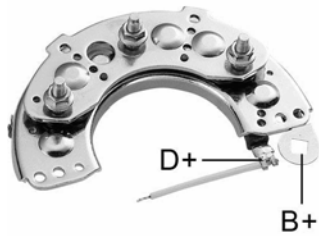

- \*111mm OD
- \*Copper Heat Sinks
- \*M5 Battery Post w/diode Trio
- \*6-35 Amp Diodes

**Replaces**

**HITACHI :**  
L150-13204  
**ISUZU :**  
8-94237-729-0  
**NISSAN :**  
23232-W1700

**Unit no.**

HITACHI					
LR150-117C	LR150-133B	LR150-133E	LR150-136E	LR150-147C	LR150-148C
LR150-155B	LR150-157B	LR150-158	LR150-165	LR150-201B	LR150-202
LR150-203	LR150-205B	LR150-206	LR150-211B	LR150-212B	LR150-79H
LR155-16B					
ISUZU					
5-81200-316-3	5-94111-836-0	8-94122-220-1	8-94169-952-0	8-94170-993-0	8-94241-630-2
8-94244-298-2	8-94401-793-2	8-94404-636-0	8-94405-044-2	8-94411-907-2	9-94411-908-2
NISSAN					
23099-34W01	23099-36W01	23099-36W02	23099-36W04	23100-17S00	23100-G3701
23100-W1802					

**RH-03**

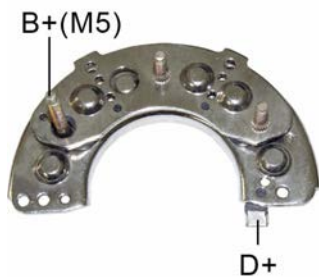

- \*111mm OD
- \*Aluminum Heat Sink
- \*M5 Battery Post w/diode Trio
- \*6-35 Amp Diodes

**Replaces**

**HITACHI :**  
L140-93202    L150-73203    L160-6320    L160-9320    L150-13206  
**ISUZU :**  
5-81262-006-0  
**NISSAN :**  
23230-W7101

**Unit no.**

HITACHI					
LR150-101B	LR150-125	LR150-125B	LR150-140	LR150-186C	LR150-98B
LR150-99	LR150-99B	LR225-68B	LR225-80	LR235-58	LR235-62
LR235-69	LR235-70	LR240-21			
ISUZU					
1-81200-262-2					
NISSAN					
23099-S9000	23099-T9004	23099-W5804	23099-Z5560	23099-Z5561	23100-C7101
23100-D0101	23100-H7702	23100-H7703	23100-M6600	23100-M6601	23100-N9502
23100-T9001	23100-W5803	23100-W5805	23100-Z5518		

**RH-03C**

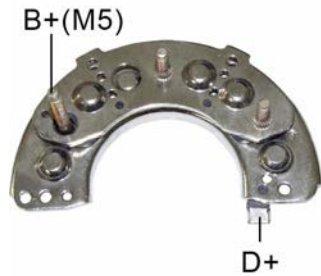

- \*111mm OD
- \*Copper Heat Sinks
- \*M5 Battery Post w/diode Trio
- \*6-35 Amp Diodes

**Replaces**

**HITACHI :**

L150-13206

**ISUZU :**

5-81262-006-0

**NISSAN :**

23230-W7101

**Unit no.**

**HITACHI**

LR150-101B	LR150-125	LR150-125B	LR150-140	LR150-186C	LR150-98B
LR150-99	LR150-99B	LR225-68B	LR225-80	LR235-58	LR235-62
LR235-69	LR235-70	LR240-21			

**ISUZU**

1-81200-262-2

**NISSAN**

23099-S9000	23099-T9004	23099-W5804	23099-Z5560	23099-Z5561	23100-C7101
23100-D0101	23100-H7702	23100-H7703	23100-M6600	23100-M6601	23100-N9502
23100-T9001	23100-W5803	23100-W5805	23100-Z5518		

**RH-04**

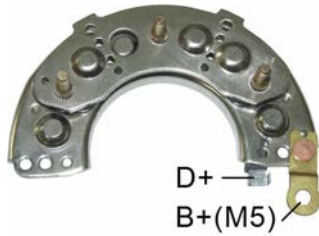

- \*111mm OD
- \*Aluminum Heat Sink
- \*M5 Battery Post w/diode Trio
- \*6-35 Amp Diodes

**Replaces**

**HITACHI :**

L140-13202	L140-53202	L150-43203	L150-83201	L150-83202	L160-13202
L160-4320	L160-53202	L160-7320	L160-93201	L170-5320	L225-4320
L225-6320					

**ISUZU :**

8-94167-411-0

**NISSAN :**

23232-16A00	28230-E3200	23232-09W01	23232-10G01	23232-18A00	23232-18G00
23232-V6601					

**Unit no.**

**HITACHI**

LR140-130P	LR140-402	LR140-408	LR140-415	LR150-139P	LR150-401C
LR150-402C	LR150-403	LR150-421C	LR150-423	LR150-425B	LR150-431
LR155-16P	LR155-408	LR160-401	LR160-401C	LR225-402	LR225-403
LR225-410	LR225-65P	LR225-67P			

**ISUZU**

8-94122-488-3      8-94452-739-0

**NISSAN**

23099-09W00	23099-29W00	23099-C6808	23099-C8600	23099-R8109	23099-R8110
23099-R8111	23099-R8701	23099-R8741	23099-V1708	23100-10G04	23100-16A01
23100-17A01	23100-18A00	23100-18A01	23100-18G02	23100-C8602	23100-C8604

**RH-04C**

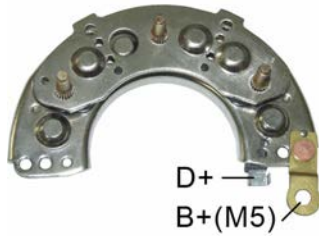

- \*111mm OD
- \*Copper HEat Sinks
- \*M5 Battery Post w/diode Trio
- \*6-35 Amp Diodes

**Replaces**

**HITACHI :**

L140-13202      L140-53202      L150-83201      L150-83202      L160-4320

**ISUZU :**

8-94167-411-0

**NISSAN :**

23232-09W01      23232-10G01      23232-18A00      23232-18G00      23232-V6601

**Unit no.**

**HITACHI**

LR140-130P	LR140-402	LR140-408	LR140-415	LR150-139P	LR150-401C
LR150-402C	LR150-403	LR150-421C	LR150-423	LR150-425B	LR150-431
LR155-16P	LR155-408	LR160-401	LR160-401C	LR225-402	LR225-403
LR225-410	LR225-65P	LR225-67P			

**ISUZU**

8-94122-488-3      8-94452-739-0

**NISSAN**

23099-09W00	23099-29W00	23099-C6808	23099-C8600	23099-R8109	23099-R8110
23099-R8111	23099-R8701	23099-R8741	23099-V1708	23100-10G04	23100-16A01
23100-17A01	23100-18A00	23100-18A01	23100-18G02	23100-C8602	23100-C8604



**RH-04N**



- \*111mm OD
- \*Iron Heat Sink
- \*M5 Battery Post w/diode Trio
- \*6-35 Amp Diodes

**Replaces**

**HITACHI :**

L140-13202	L140-53202	L150-43203	L150-83201	L150-83202	L160-13202
L160-13203	L160-4320	L160-53202	L160-7320	L160-93201	L170-5320
L170G-63201	L225-4320	L225-6320			

**ISUZU :**

8-94167-411-0

**NISSAN :**

23232-02N09	23232-16A00	28230-E3200	23232-09W01	23232-10G01	23232-18A00
23232-18G00	23232-V6601				

**Unit no.**

**HITACHI**

LR140-130P	LR140-402	LR140-408	LR140-415	LR150-139P	LR150-401C
LR150-402C	LR150-403	LR150-421C	LR150-423	LR150-425B	LR150-431
LR155-16P	LR155-408	LR160-401	LR160-401C	LR225-402	LR225-403
LR225-410	LR225-65P	LR225-67P			

**ISUZU**

8-94122-488-3    8-94452-739-0

**NISSAN**

23099-09W00	23099-29W00	23099-C6808	23099-C8600	23099-R8109	23099-R8110
23099-R8111	23099-R8701	23099-R8741	23099-V1708	23100-10G04	23100-16A01
23100-17A01	23100-18A00	23100-18A01	23100-18G02	23100-C8602	23100-C8604

**RH-05C**



- \*100mm OD
- \*Copper Heat Sinks
- \*6-35 Amp Diodes w/diode trio

**Replaces**

**HITACHI :**

L150-43202

**ISUZU :**

8-94424-362-0

**Unit no.**

**HITACHI**

LR155-504

**ISUZU**

8-94362-744-0

**RH-06C**

- \*111mm OD
- \*Copper Heat Sinks
- \*6-35 Amp Diodes



**Replaces**

**HITACHI :**

L150-13205

**ISUZU :**

8-94223-968-0

**Unit no.**

HITACHI

LR150-155B

LR150-78E

LR155-12C

LT150-112C

LT150-115C

LT150-116C

LT150-154

LT150-196

LT150-77C

LT225-73

LT225-75

LT225-76B

ISUZU

5-81200-294-2

5-81200-295-2

5-81200-301-2

5-81200-302-2

5-81200-348-0

5-81200-351-0

5-81200-351-1

5-94150-397-0

8-94221-450-3

8-94246-251-0

**RH-08C**

- \*111mm OD
- \*Copper Heat Sinks
- \*M6 Battery Post w/diode Trio
- \*6-35 Amp Diodes

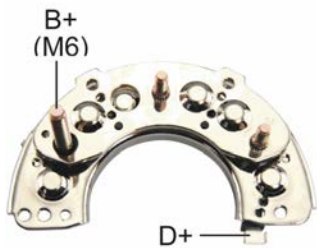

**Replaces**

**HITACHI :**

L160-33202

L160-73202

**Unit no.**

HITACHI

LR150-194B

LR150-197

LR150-197B

LR160-140B

LR160-151

NISSAN

23100-80W00



**RH-103**

- \*114mm OD
- \*M6 Battery Post
- \*6-50A Avalanche Diodes

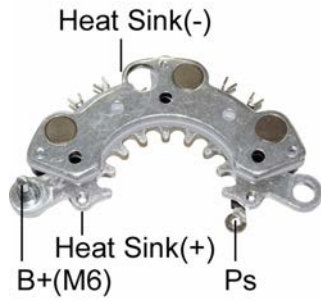

Unit no.   
HITACHI  
LR180-769  
NISSAN  
23100-4Z400

**RH-104**

- \*119mm OD
- \*M6 Battery Post
- \*8-35A Avalanche Diodes

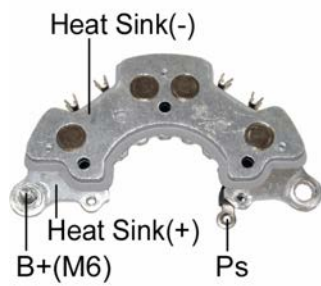

Unit no.   
HITACHI  
LR1110-501  
SUZUKI  
89724-82970

**RH-10C**

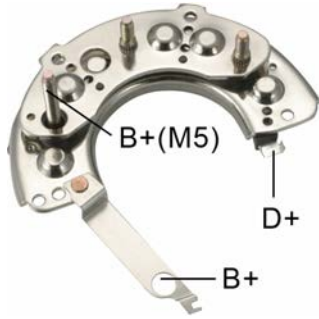

- \*111mm OD
- \*Copper HEat Sinks
- \*Same as RH-03C except with Strap Terminal
- \*M5 Battery Post w/diode Trio
- \*6-35 Amp Diodes

**Replaces**

**HITACHI :**

L150-13206

**ISUZU :**

5-81262-006-0

**NISSAN :**

23230-W7101

**Unit no.**

**HITACHI**

LR150-101B	LR150-125	LR150-125B	LR150-140	LR150-186C	LR150-98B
LR150-99	LR150-99B	LR225-68B	LR225-80	LR235-58	LR235-62
LR235-69	LR235-70	LR240-21			

**ISUZU**

1-81200-262-2

**NISSAN**

23099-S9000	23099-T9004	23099-W5804	23099-Z5560	23099-Z5561	23100-C7101
23100-D0101	23100-H7702	23100-H7703	23100-M6600	23100-M6601	23100-N9502
23100-T9001	23100-W5803	23100-W5805	23100-Z5518		

**RH-111**

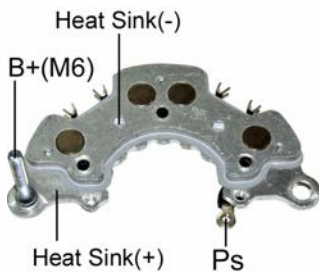

- \*119mm OD
- \*M6 Battery Post
- \*8-50A Avalanche Diodes

**Unit no.**

**HITACHI**

LR280-501	LR280-506	LR280-508
-----------	-----------	-----------

**ISUZU**

8-97248-914-1	8-97332-502-0	8-97351-574-0
---------------	---------------	---------------

**RH-113**

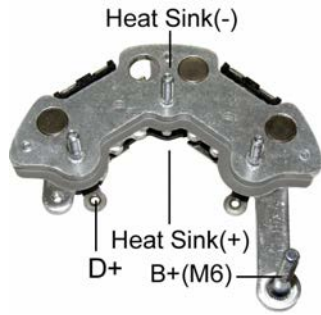

- \*119mm OD
- \*M6 Battery Post w/diode Trio
- \*6-35A Avalanche Diodes

Unit no.   
 HITACHI  
 LR190-502B      LR190-502C  
 NISSAN  
 23100-05D01

**RH-115**



- \*119mm OD
- \*M8 Battery Post
- \*8-50A Avalanche Diodes

Unit no.   
 HITACHI  
 LR280-708B

**RH-116**

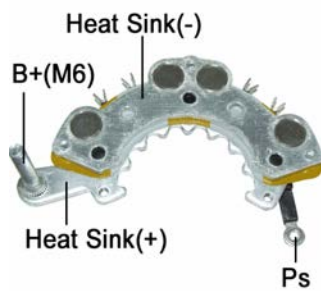

- \*114mm OD
- \*8-50 Amp Diodes
- \*M6 Battery Post

Unit no.   
 HITACHI  
 LR250-508

**RH-117**

- \*114mm OD
- \*8-50 Amp Diodes
- \*M8 Battery Post

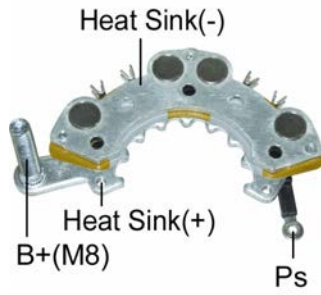

Unit no.   
HITACHI  
LR250-707

**RH-119**

- \*114mm OD
- \*8-35A Amp Diodes
- \*M6 Battery Post

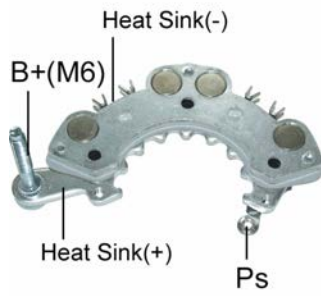

Unit no.   
HITACHI  
LR250-517

**RH-11C**

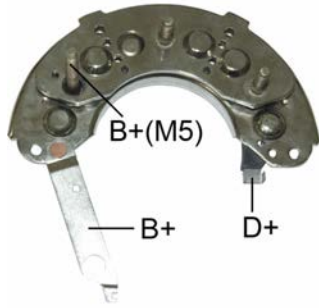

- \*118mm OD
- \*Copper Heat Sinks
- \*Same as RH-01C except with Strap Terminal(66mm X 2.5mm)
- \*M5 Battery Post w/diode Trio
- \*6-35 Amp Diodes

**Replaces**

**HITACHI :**

L150-13203      L160-3320

**NISSAN :**

23230-06500      23230-Q4601

**SUBARU :**

49534-7101

**Unit no.**

**HITACHI**

LR155-15C	LR160-104	LR160-105	LR160-109	LR160-110	LR160-116
LR160-117	LR160-130	LR160-133	LR160-78	LR160-78B	LR160-82
LR160-82B	LR160-84	LR160-84B	LR160-93	LR170-14	LR170-18
LT150-113	LT150-114	LT150-123			

**NISSAN**

23100-29R00	23100-D0201	23100-D0800	23100-D1700	23100-D3300	23100-H7205
23100-V0101	23100-V0102	23100-V0106	23100-V0107	23100-W5806	23100-W5807

**SUBARU**

23700-AA00Q	23700-AA020	23700-AA160	42990-7000	42990-7010	42990-7300
42990-7320	42990-7330	42990-7340	42990-7400	42990-7500	42990-7600
42990-7700					

**RH-120**

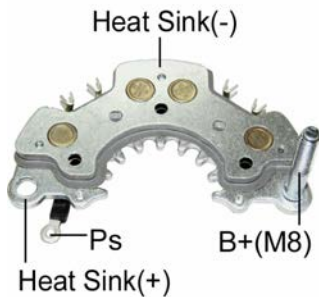

- \*119mm OD
- \*M8 Battery Post
- \*8-35A Avalanche Diodes

**Unit no.**

HITACHI  
LR1110-712

**Used On**

**INFINITI**

QX4      2001-2002

**NISSAN**

Pathfinder      2001-2002



**RH-121**

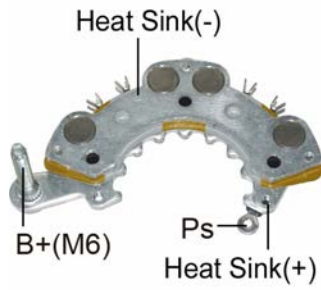

- \*114mm OD
- \*M6 Battery Post
- \*8-35A Avalanche Diodes

Unit no.   
 HITACHI  
 L250G-13081

**RH-122**

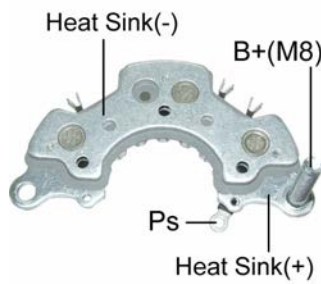

- \*119mm OD
- \*M8 Battery Post w/diode Trio
- \*6-50A Avalanche Diodes

Unit no.   
 HITACHI  
 LR1110-503

**RH-123**

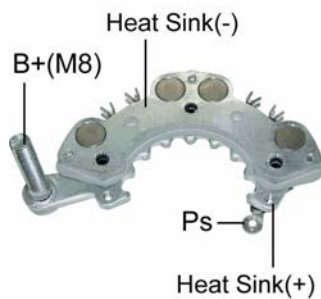

- \*114mm OD
- \*M8 Battery Post
- \*8-35A Avalanche Diodes

Unit no.   
 HITACHI  
 LR160-502E      LR160-503E      LR180-512  
 ISUZU  
 89724-02702

**RH-12C**

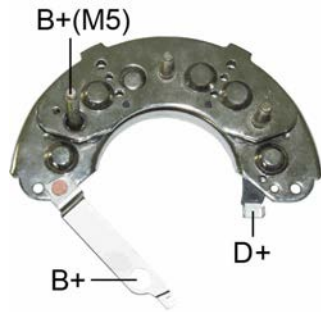

- \*118mm OD
- \*Copper Heat Sinks
- \*Same as RH-01C except with Strap Terminal.(66mm X 8.6mm)
- \*M5 Battery Post w/diode Trio
- \*6-35 Amp Diodes

**Replaces**

**HITACHI :**

L150-13203      L160-3320

**NISSAN :**

23230-06500      23230-Q4601

**SUBARU :**

49534-7101

**Unit no.**

**HITACHI**

LR155-15C	LR160-104	LR160-105	LR160-109	LR160-110	LR160-116
LR160-117	LR160-130	LR160-133	LR160-78	LR160-78B	LR160-82
LR160-82B	LR160-84	LR160-84B	LR160-93	LR170-14	LR170-18
LT150-113	LT150-114	LT150-123			

**NISSAN**

23100-29R00	23100-D0201	23100-D0800	23100-D1700	23100-D3300	23100-H7205
23100-V0101	23100-V0102	23100-V0106	23100-V0107	23100-W5806	23100-W5807

**SUBARU**

23700-AA00Q	23700-AA020	23700-AA160	42990-7000	42990-7010	42990-7300
42990-7320	42990-7330	42990-7340	42990-7400	42990-7500	42990-7600
42990-7700					

**RH-13C**

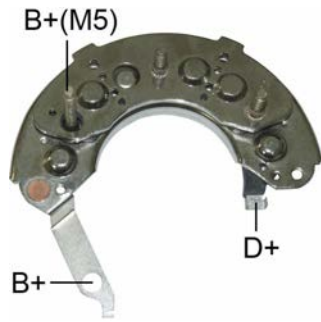

- \*118mm OD
- \*Copper Heat Sinks
- \*Same as RH-01C except with Strap Terminal(56mm X 16.5mm)
- \*M5 Battery Post w/diode Trio
- \*6-35 Amp Diodes

**Replaces**

**HITACHI :**

L150-13203      L160-3320

**NISSAN :**

23230-06500      23230-Q4601

**SUBARU :**

49534-7101

**Unit no.**

**HITACHI**

LR155-15C	LR160-104	LR160-105	LR160-109	LR160-110	LR160-116
LR160-117	LR160-130	LR160-133	LR160-78	LR160-78B	LR160-82
LR160-82B	LR160-84	LR160-84B	LR160-93	LR170-14	LR170-18
LT150-113	LT150-114	LT150-123			

**NISSAN**

23100-29R00	23100-D0201	23100-D0800	23100-D1700	23100-D3300	23100-H7205
23100-V0101	23100-V0102	23100-V0106	23100-V0107	23100-W5806	23100-W5807

**SUBARU**

23700-AA00Q	23700-AA020	23700-AA160	42990-7000	42990-7010	42990-7300
42990-7320	42990-7330	42990-7340	42990-7400	42990-7500	42990-7600
42990-7700					

**RH-14C**

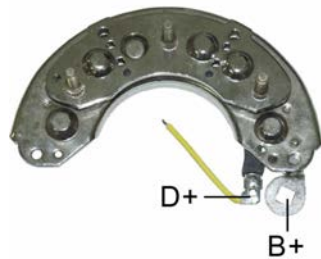

- \*118mm OD
- \*Copper Heat Sinks
- \*w/diode Trio
- \*6-35 Amp Diodes

**Replaces**

**HITACHI :**

L160-23201

**ISUZU :**

8-94116-432-0

**NISSAN :**

23232-W1705

**Unit no.**

**HITACHI**

LR160-107B	LR160-108B	LR160-143B	LR160-144	LR160-146B	LR160-147F
LR160-148F	LR160-152F	LR160-164	LR160-67H	LR160-92C	LR160-96H
LR160-97B					

**ISUZU**

8-94155-308-5	8-94155-309-5	8-94407-184-0	8-94407-185-0	8-94408-918-4	
---------------	---------------	---------------	---------------	---------------	--

**NISSAN**

23099-W1705	23100-11H00	23100-17S05	23100-G3706	23100-G4100	23100-W1807
23100-W3405					

**RH-15**

- \*118mm OD
- \*Aluminum Heat Sinks
- \*6-35 Amp Diodes
- \*w/Diode Trios

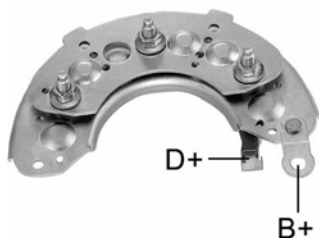

**Replaces**

**HITACHI :**

L160-23202      L160-43202

**NISSAN :**

23245-V7200

**Unit no.**

HITACHI

LR160-422B      LR170-402      LR170-404      LR170-406B

NISSAN

23100-54A02      23100-V7204

**RH-15C**

- \*118mm OD
- \*Copper Heat Sinks
- \*w/diode Trio
- \*6-35 Amp Diodes

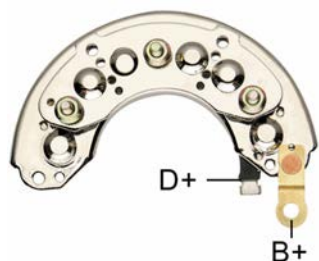

**Replaces**

**HITACHI :**

L160-23202      L160-43202

**NISSAN :**

23245-V7200

**Unit no.**

HITACHI

LR160-422B      LR170-402      LR170-404      LR170-406B

NISSAN

23100-54A02      23100-V7204

**RH-16C**

- \*100mm OD
- \*Copper Heat Sinks
- \*6-35 Amp Diodes



**Replaces**

**HITACHI :**  
L140-23201

**ISUZU :**  
5-81218-029-0

**MAZDA :**  
1456-24-510

**Unit no.**

HITACHI			
LT135-63B	LT140-109B	LT140-109C	LT140-110B
ISUZU			
5-81200-266-4	5-81200-279-2		
MAZDA			
1456-18-300A			

**RH-17C**

- \*100mm OD
- \*Copper Heat Sinks
- \*w/diode Trio
- \*6-35 Amp Diodes

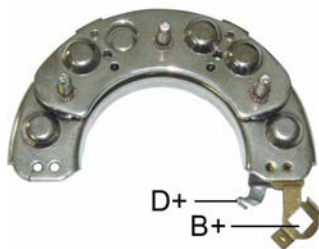

**Replaces**

**HITACHI :**  
L140-53201

**ISUZU :**  
8-94246-957-1

**Unit no.**

HITACHI	
LR140-131	LR140-131B

**RH-18C**

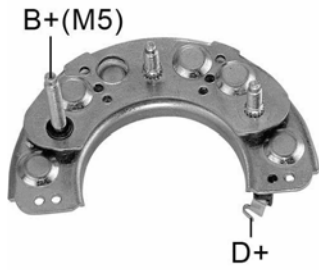

- \*100mm OD
- \*Copper Heat Sinks
- \*M5 Battery Post w/diode Trio
- \*6-35 Amp Diodes

**Replaces**

**HITACHI :**  
L135-13208  
**NISSAN :**  
23230-37504

**Unit no.**

HITACHI					
LR120-123	LR120-16B	LR135-104	LR135-116	LR135-125	LR135-127
LR135-128	LR135-95				

**RH-19C**



- \*100mm OD
- \*Copper Heat Sinks
- \*w/diode Trio
- \*6-35 Amp Diodes

**Replaces**

**HITACHI :**  
L135-6320  
**NISSAN :**  
23230-01B00

**Unit no.**

HITACHI	
LR140-132	LR140-133
NISSAN	
23100-01B05	23100-03B05

**RH-20C**



- \*100mm OD
- \*Copper Heat Sinks
- \*M5 Battery Post w/diode Trio
- \*6-35 Amp Diodes

**Replaces**

**HITACHI :**  
L135-3320  
**ISUZU :**  
8-42213-40  
**YANMAR :**  
L135-332000

**Unit no.**

HITACHI  
LR135-105      LR135-126      LR135-74

**RH-21**

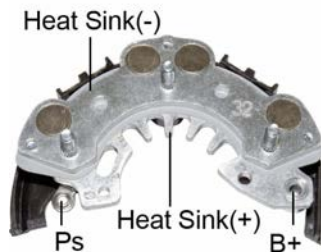

- \*103mm OD
- \*8-35 Amp Diodes

**Replaces**

**HITACHI :**  
L170-33202  
**SUBARU :**  
23830-AA040

**Unit no.**

HITACHI  
LR170-732B      LR170-732C  
SUBARU  
23700-AA090

**RH-22**

\*103mm OD  
 \*M6 Battery Post w/diode Trio  
 \*6-35 Amp Diodes

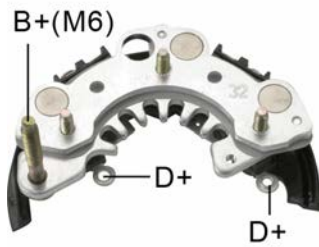

**Replaces**

**HITACHI :**  
 L170-43202      L170G-3320      L170G-6320      L180G-1320  
**NISSAN :**  
 23230-77P00      23230-53F00      23230-12G01

**Unit no.**

**HITACHI**  
 LR170-734      LR170-734B      LR170-739  
**NISSAN**  
 23100-12B02      23100-88G00

**RH-23**

\*103mm OD  
 \*M5 Battery Post w/diode Trio  
 \*6-35 Amp Diodes  
 \*w/diode trio

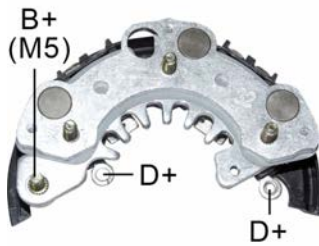

**Replaces**

**HITACHI :**  
 L180-13202  
**NISSAN :**  
 23230-64J00

**Unit no.**

**HITACHI**  
 LR160-723      LR160-723B      LR180-725  
**NISSAN**  
 23100-80G09R



**RH-24**

- \*103mm OD
- \*M5 Battery Post
- \*8-35 Amp Diodes

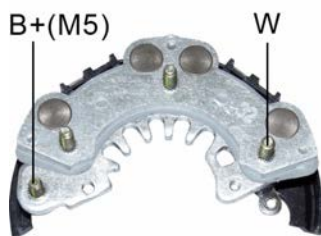

**Replaces**

**HITACHI :**  
L170-23203

**NISSAN :**  
23230-50Y06

**Unit no.**

HITACHI	
LR170-738	LR170-738B
NISSAN	
23100-50Y06	23100-50Y09

**RH-25**

- \*103mm OD
- \*M6 Battery Post
- \*8-35 Amp Diodes

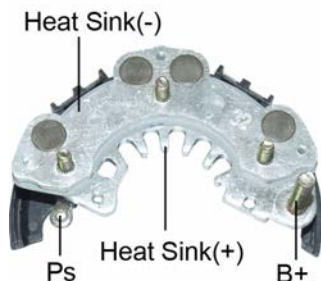

**Replaces**

**HITACHI :**  
L170G-2320

**NISSAN :**  
23230-0E705

**Unit no.**

HITACHI	
LR170-738C	
NISSAN	
23100-0E705	

**RH-26**

- \*103mm OD
- \*M6 Battery Post w/diode Trio
- \*8-35 Amp Diodes

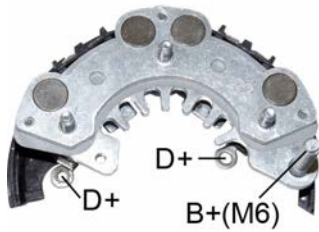

**Replaces**

**HITACHI :**  
L170G-1320  
**NISSAN :**  
23230-50Y09

**Unit no.**

HITACHI  
LR160-726      LR170-738B  
NISSAN  
23100-50Y09

**RH-27**

- \*118mm OD
- \*Aluminum Heat Sink
- \*M6 Battery Post w/diode Trio
- \*6-35 Amp Diodes

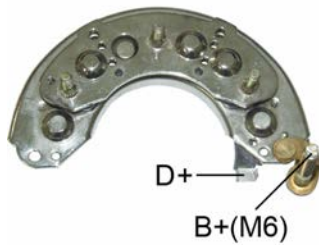

**Replaces**

**HITACHI :**  
L170-93202      L170G-73201      L170G-8320

**Unit no.**

HITACHI  
LR170-417      LR170-417C      LR170-417E      LR170-417F

**RH-27C**

- \*118mm OD
- \*Copper Heat Sink
- \*M6 Battery Post w/diode Trio
- \*6-35 Amp Diodes

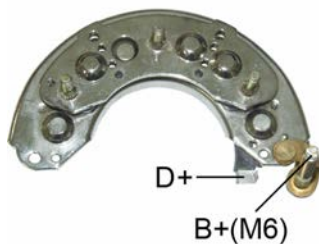

**Replaces**

**HITACHI :**  
L170-93202      L170G-73201      L170G-8320

**Unit no.**

HITACHI  
LR170-417B      LR170-417C      LR170-417E      LR170-417F

**RH-28**

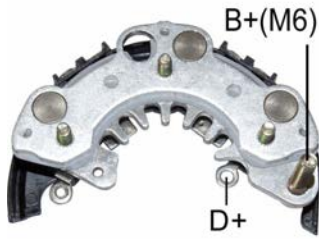

- \*103mm OD
- \*M6 Battery Post
- \*6-35 Amp Diodes

Unit no.   
 HITACHI  
 LR150-711

**RH-29**

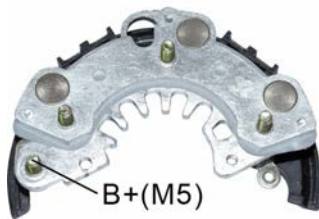

- \*103mm OD
- \*M5 Battery Post
- \*6-35 Amp Diodes

**Replaces**   
**HITACHI :**  
 L180G-7320  
**NISSAN :**  
 23230-1E400      23230-56G00  
 Unit no.   
 HITACHI  
 LR170-739      LR180-725B      LR180-725C      LR180-736B  
 NISSAN  
 23100-1E400

**RH-30**

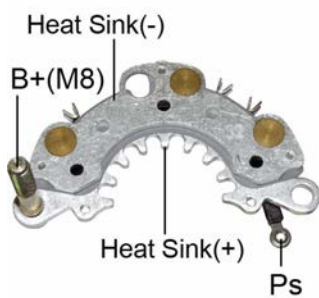

- \*114mm OD
- \*M8 Battery Post
- \*6-35 Amp Diodes

Unit no.   
 HITACHI  
 LR170-745

**RH-31**

\*114mm OD  
 \*M8 Battery Post  
 \*8-35 Amp Diodes

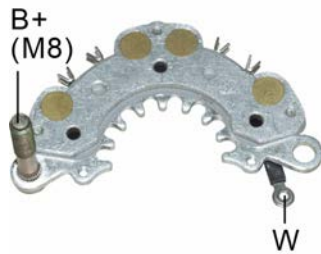

Unit no.

HITACHI  
 LR170-748      LR170-748B      LR180-751      LR190-729

**RH-32**

\*114mm OD  
 \*M6 Battery Post  
 \*6-35 Amp Diodes

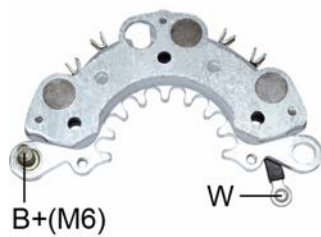

Unit no.

HITACHI  
 LR180-741H      LR180-744  
 NISSAN  
 23100-1E800

**RH-33**

\*114mm OD  
 \*M6 Battery Post  
 \*8-35 Amp Diodes

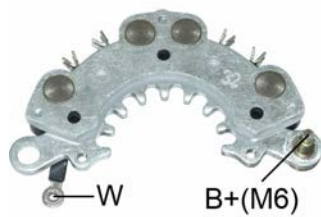

**Replaces**

**HITACHI :**  
 L190G-33204      L190G-63205  
**SUBARU :**  
 23830-AA100      23830-AA140      23830-AA180

Unit no.

HITACHI  
 LR190-724  
 NISSAN  
 23100-70F05

**RH-34**

\*119mm OD  
 \*M8 Battery Post w/diode Trio  
 \*6-35 Amp Diodes

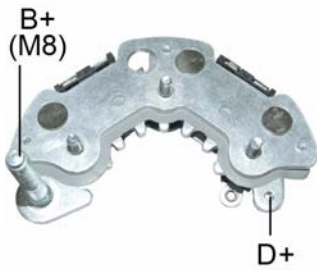

**Replaces**

**HITACHI :**  
 L1110G-748B  
**NISSAN :**  
 23230-60401

**Unit no.**

HITACHI  
 LR1100-702      LR1100-702C  
 NISSAN  
 23100-61U00

**RH-35**

\*119mm OD  
 \*M6 Battery Post  
 \*8-40A Avalanche Diodes

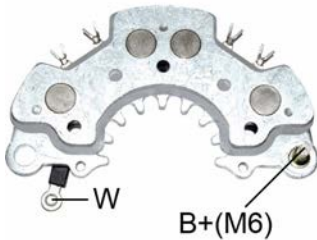

**Replaces**

**HITACHI :**  
 L1110G-4320      L1125G-2320

**Unit no.**

HITACHI  
 LR1110-705      LR1125-702B  
 NISSAN  
 23100-31U01      23100-31U02

**RH-36**

\*119mm OD  
 \*M8 Battery Post w/diode Trio  
 \*8-35 Amp Diodes

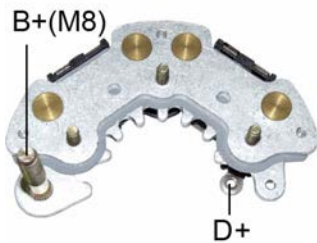

**Replaces**

**HITACHI :**  
 L1110-1320

**Unit no.**

HITACHI  
 LR1110-701      LR1110-702  
 NISSAN  
 23100-60U00      23100-91U00

**RH-37**

\*119mm OD  
 \*M8 Battery Post w/o diode Trio  
 \*8-35 Amp Diodes

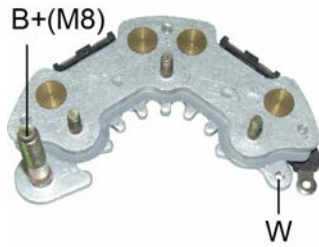

**Replaces**

**HITACHI :**  
 L1110G-3320  
**NISSAN :**  
 23230-0P605

**Unit no.**

HITACHI  
 LR1110-701B  
 NISSAN  
 23100-60U02

**RH-38**

\*119mm OD  
 \*M8 Battery Post w/diode Trio  
 \*6-35 Amp Diodes

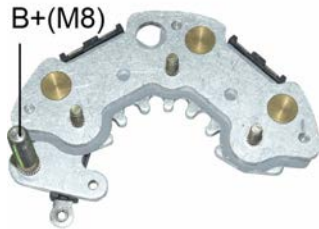

**Replaces**

**HITACHI :**  
 84201040            L195G-1320  
**NISSAN :**  
 23230-97E02

**Unit no.**

HITACHI  
 LR195-701  
 NISSAN  
 23100-97E01

**RH-39C**

- \*100mm OD
- \*Copper Heat Sinks
- \*w/diode Trio
- \*6-35 Amp Diodes

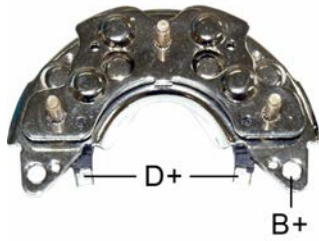

**Replaces**

**HITACHI :**  
L170-9320

**NISSAN :**  
23230-51S00

**Unit no.**

HITACHI		
LR150-704	LR150-715	LR170-716B
NISSAN		
23100-51S00	23100-53A00	23100-D4405

**RH-40C**

- \*100mm OD
- \*Copper Heat Sinks
- \*w/diode Trio
- \*8-35 Amp Diodes

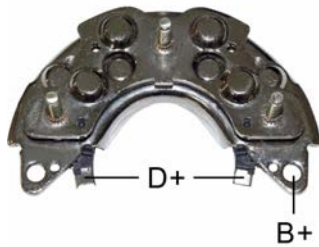

**Replaces**

**HITACHI :**  
L165-6320      L165-7320      L170-7302

**NISSAN :**  
23230-77A00

**SUBARU :**  
23830-AA020

**Unit no.**

HITACHI		
LR165-704B	LR165-707B	LR180-715
NISSAN		
23100-77A00		
SUBARU		
23700-AA150		

**RH-42C**

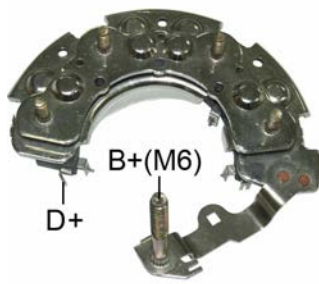

- \*113mm OD
- \*Copper Heat Sinks
- \*M6 Battery Post w/diode Trio
- \*6-35 Amp Diodes

**Replaces**

<b>HITACHI :</b>	
L180-2320	L180-6320
<b>NISSAN :</b>	
23230-16E05	23230-26E60

**Unit no.**

HITACHI				
LR170-713	LR170-721	LR180-704	LR180-715	LR190-704
NISSAN				
23100-16E05	23100-26E05	23100-26E61	23100-30R00	23100-F6101

**RH-43C**

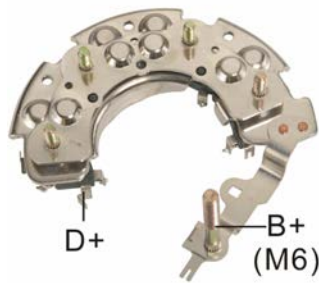

- \*113mm OD
- \*Copper Heat Sinks
- \*M6 Battery Post w/diode Trio
- \*8-35 Amp Diodes

**Replaces**

<b>HITACHI :</b>		
L190-1320	L190-3320	L190-5320
<b>NISSAN :</b>		
23230-F6101	23230-V4360	

**Unit no.**

HITACHI					
LR190-701B	LR190-702B	LR190-702C	LR190-703B	LR190-704B	LR190-708C
LR190-711					
NISSAN					
23100-85E00	23100-V4060	23100-V4360	23100-V4365	23100-V4560	



**RH-44C**

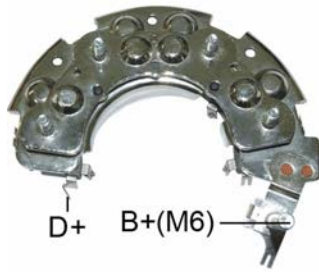

- \*113mm OD
- \*Copper Heat Sinks
- \*M6 Battery Post w/diode Trio
- \*8-35 Amp Diodes

**Replaces**

**HITACHI :**

L180-93201      L190-4320

**NISSAN :**

23230-30P00      23230-F6500

**Unit no.**

HITACHI

LR180-724      LR190-706      LR190-707

NISSAN

23100-30P00

**RH-45C**

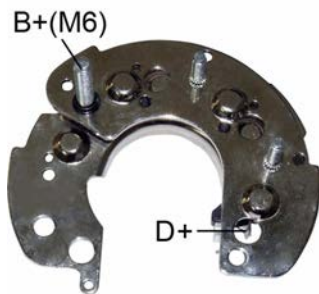

- \*103mm OD
- \*Copper Heat Sinks
- \*M6 Battery Post w/diode Trio
- \*6-35 Amp Diodes

**Replaces**

**NISSAN :**

23230-05P01

**Unit no.**

HITACHI

LR170-701B      LR170-702B

NISSAN

23100-05P01      23100-15P01

**RH-46C**



- \*104mm OD
- \*Copper Heat Sinks
- \*M6 Battery Post w/diode Trio
- \*6-35 Amp Diodes

**Replaces**

**HITACHI :**  
L170-2320

**NISSAN :**  
23230-02E00

**Unit no.**

HITACHI		
LR160-708	LR160-709	LR160-710
NISSAN		
23100-02E00	23100-02E05	

**RH-47C**

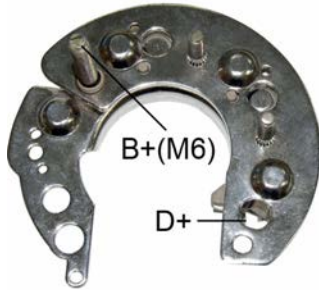

- \*95mm OD
- \*Copper Heat Sinks
- \*M6 Battery Post w/diode Trio
- \*6-35 Amp Diodes

**Replaces**

**HITACHI :**  
L150-73202      L170-93202

**Unit no.**

HITACHI	
LR150-703	LR150-99

**RH-48**

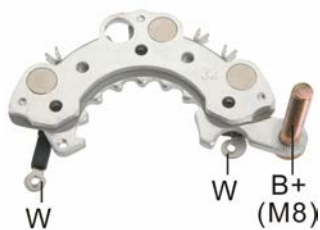

- \*115mm OD
- \*M8 Battery Post
- \*6-35 Amp Diodes

**Replaces**

**HITACHI :**  
L170G-3319

**Unit no.**

LUCAS  
LRB303

**RH-49**

\*6-35 Amp Diodes



**Replaces**

**HITACHI :**

L125-6320	L125-8320	L140-6320	L140-7320	L140-9320	L160-13201
-----------	-----------	-----------	-----------	-----------	------------

**ISUZU :**

5-81200-084-0	5-81200-114-0	5-81218-001-0	5-81218-021-0	5-81218-022-0	8-94206-081-0
9-82231-619-0					

**LUCAS :**

21511125	UBJ102
----------	--------

**NISSAN :**

23230-H0300	23230-U0100	23232-B8000	23232-E6601	23232-H6200	23232-N3300
-------------	-------------	-------------	-------------	-------------	-------------

23232-U0102

**SUBARU :**

31441-00-808

**Unit no.**

**HITACHI**

LR135-30	LR135-35	LR135-73	LR150-05	LR150-21	LR150-22
LR150-23	LR150-26	LT115-52	LT120-05	LT120-07	LT120-21
LT130-81	LT130-89	LT135-17	LT135-22	LT135-24B	LT135-26
LT135-30	LT135-35	LT135-35C	LT135-38C	LT135-54	LT135-68
LT135-73	LT135-73B	LT150-03	LT150-05	LT150-10	LT150-21
LT150-22	LT150-23	LT150-26	LT160-32	LT210-01	LT215-27

**ISEKI**

6581-200-272-0

**ISUZU**

5-81200-101-1	5-81200-109-0	5-81200-114-0	5-81200-170-0	8-94206-081-0	9-82200-763-0
9-82200-764-0					

**NISSAN**

012149277200	012475677200	18504-6071	23100-0100	23100-61700	23100-77A00
23100-80210	23100-80W00	23100-90060	23100-91004	23100-A4601	23100-A4602
23100-C0403	23100-C6000	23100-H0300	23100-H7203	23100-L1802	23100-M0400
23100-M0401	23100-M0402	23100-P0102	23100-P0111	23100-P0112	23100-P4502
23100-Q4500	23100-U0100	23100-U0101	23100-U0102	23100-U0103	23100-U5802

**SUBARU**

32990-53300

**RH-50**

\*6-35 Amp Diodes

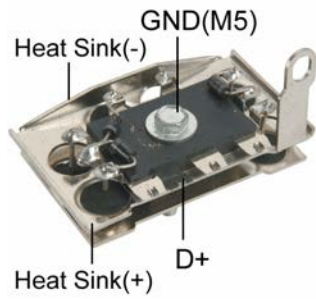

**Replaces**

**LUCAS :**  
21511112            UBJ105

**NISSAN :**  
23230-E3200

**Unit no.**

HITACHI					
LR140-130P	LR140-402	LR150-02	LR150-11	LR150-11A	LR150-421C
LR150-432	LR150-434B	LR225-402	LR225-407		
NISSAN					
23100-P2500	23100-P2501	23100-U9500			

**RH-51**

\*6-35 Amp Diodes

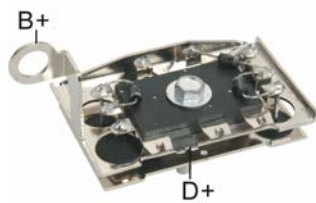

**Replaces**

**HITACHI :**  
L135N-13201        L150N-13202

**LUCAS :**  
21511119

**MAGNETI MARELLI :**  
940038249

**NISSAN :**  
23230-B9800        23230-P2501

**Unit no.**

HITACHI					
LR135-36	LR135-44	LR135-51	LR135-53		
NISSAN					
23100-B9800	23100-B9801	23100-H7700	23100-H7701	23100-P2506	

**RH-53C**

- \*100mm OD
- \*Copper Heat Sinks
- \*M6 Battery Post w/diode Trio
- \*8-35 Amp Diodes

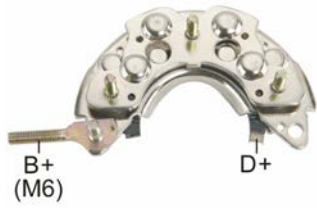

**Replaces**

**HITACHI :**  
L170G-73202

**RH-58C**

- \*119mm OD
- \*Copper Heat Sinks
- \*M6 Battery Post w/diode Trio
- \*6-35 Amp Diodes

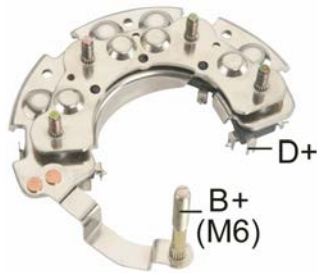

**Replaces**

**HITACHI :**  
L180G-8320

**ISUZU :**  
8-97062651-0

**Unit no.**

**HITACHI**  
LR180-501      LR180-501B

**RH-59C**

- \*98mm OD
- \*Copper Heat Sinks
- \*M6 Battery Post w/diode Trio
- \*6-35 Amp Diodes

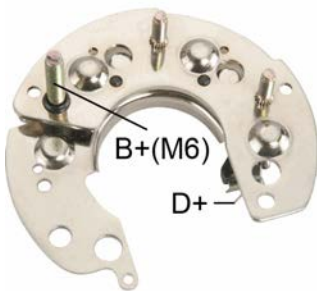

**Replaces**

**HITACHI :**  
L160-33201

**Unit no.**

**HITACHI**  
LR160-702B      LR160-703B

**RH-60**

\*118mm OD  
 \*M6 Battery Post  
 \*6-35Amp Diodes

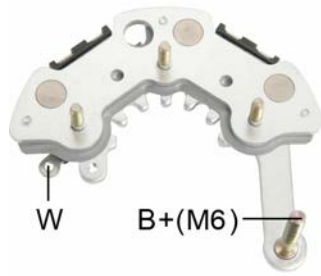

**Replaces**

HITACHI :  
 L190G-33201

Unit no.

HITACHI  
 LR170-502C      LR190-505E      LR190-511      LR190-511B

**RH-61**

\*118mm OD  
 \*M8 Battery Post  
 \*8-35 Amp Diodes

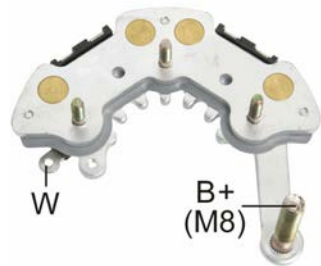

**Replaces**

HITACHI :  
 L1100G-5320

Unit no.

HITACHI  
 LR190-512C  
 NISSAN  
 23100-5C310

**RH-62**

\*118mm OD  
 \*M6 Battery Post  
 \*6-35 Amp Diodes

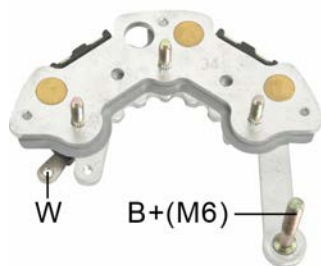

Unit no.

NISSAN  
 23100-56G00

**RH-63**

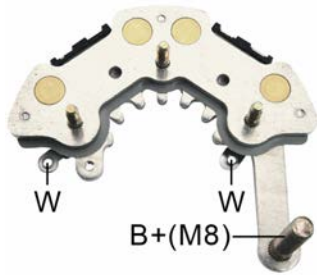

- \*118mm OD
- \*w/two terminals
- \*M8 Battery Post
- \*8-35 Amp Diodes

Unit no.   
 HITACHI  
 LR1100-501B

**RH-65**

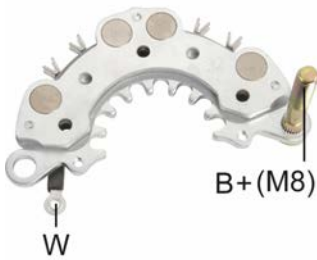

- \*114mm OD
- \*M8 Battery Post
- \*8-35 Amp Diodes

**Replaces**   
**HITACHI :**  
 L160G-53201  
 Unit no.   
 HITACHI  
 LR160-728B    LR160-728C    LR160-732B    LR160-732C    LR235-705

**RH-66**

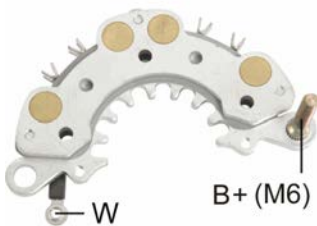

- \*114mm OD
- \*M6 Battery Post
- \*8-35 Amp Diodes

Unit no.   
 HITACHI  
 LR170-755  
 ISUZU  
 8-97130-776-0

**RH-66A**

- \*114mm OD
- \*M6 Battery Post
- \*8-50A Avalanche Diodes

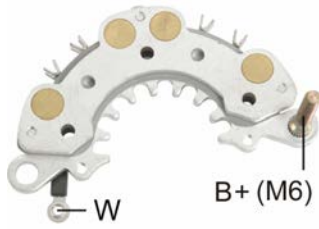

Unit no.

HITACHI  
LR170-755

**RH-67A**

- \*110mm OD
- \*M6 Battery Post
- \*6-50A Avalanche Diodes

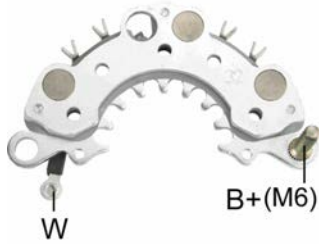

Unit no.

HITACHI  
LR160-730C      LR160-731  
ISUZU  
8-97130-752-0

**RH-68**

- \*120mm OD
- \*M8 Battery Post w/o diode Trio
- \*8-35A Avalanche Diodes
- \*For Use on 70A Alternators

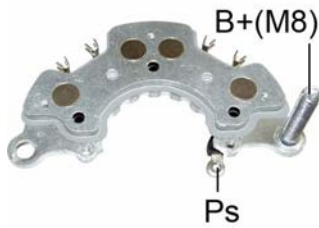

Unit no.

HITACHI  
LR1100-502E      LR1100-502F      LR1100-502G      LR1100-502J      LR170-509C      LR170-509E  
LR170-509F      LR170-509G      LR170-509H



**RH-69**

- \*114mm OD
- \*M6 Battery Post
- \*8-50A Avalance Diodes

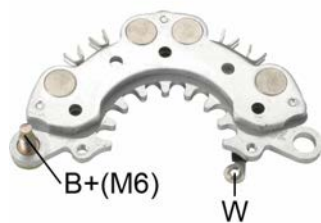

Unit no. [Redacted]

HITACHI	
LR1100-722	LR170-709B
NISSAN	
23100-5M000	23100-9E000

**RH-70**

- \*114mm OD
- \*M6 Battery Post
- \*8-35 Amp Diodes

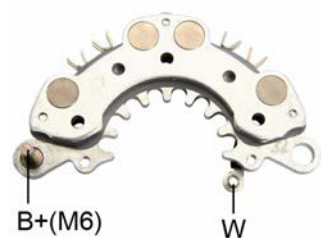

Unit no. [Redacted]

HITACHI	
LR170-757B	
NISSAN	
23100-3S500	

**RH-71**

- \*120mm OD
- \*M6 Battery Post
- \*6-50A Avalanche Diodes

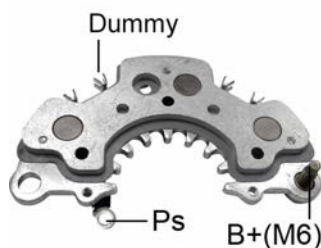

**Replaces**

<b>HITACHI :</b>	
L1100G-23201	
Unit no. [Redacted]	
HITACHI	
LR1100-711B	LR1110-725

**RH-72**

- \*115mm OD
- \*M8 Battery Post
- \*Same as RH-48 but w/6-50A Avalanche Diodes

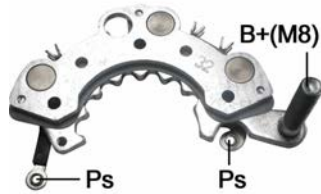

**Replaces**

HITACHI :  
L170G-3319

**Unit no.**

HITACHI  
LRB303

**RH-73**

- \*120mm OD
- \*M8 Battery Post w/o diode Trio
- \*8-50A Avalanche Diodes
- \*For Use on 100A Alternators

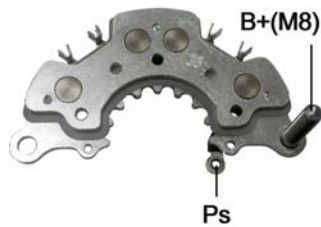

**Unit no.**

HITACHI  
LR1100-503B    LR1100-507B    LR1100-503C    LR1100-503E    LR1100-507C    LR1100-508  
LR1100-508B    LR1100-508C    LR1100-508F

**RH-74A**

- \*8-50 Amp Diodes
- \*M6 Battery Post
- \*w/Diode Trios

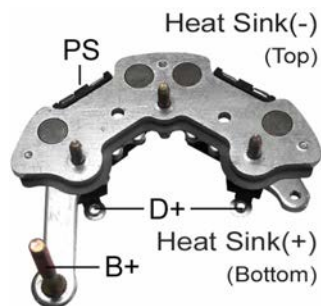

**Unit no.**

HITACHI  
LR250-502C    LR250-507    LR250-507C  
ISUZU  
8-97075-883-2    8-97148-496-0    8-97148-496-1

**RH-75**

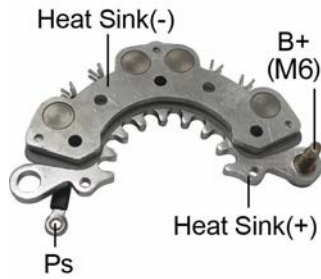

- \*124mm OD
- \*M6 Battery Post
- \*8-35A Avalanche Diodes

**Replaces**

**HITACHI :**

L190G-33204

**SUBARU :**

23830-AA100      23830-AA140

**Unit no.**

HITACHI

LR185-701      LR185-701C      LR185-702

**RH-76**



- \*110mm OD
- \*M5 Battery Post w/o diode Trio
- \*8-35 Amp Diodes

**Unit no.**

HITACHI

LR190-737      LR190-737E

NISSAN

23100-0W001

**RH-77**

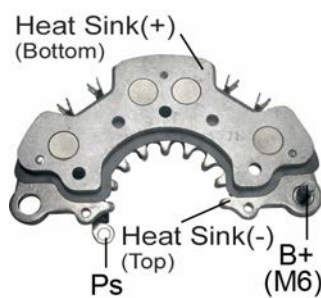

- \*120mm OD
- \*M6 Battery Post
- \*8-50A Avalanche Diodes

**Replaces**

**HITACHI :**

L1110G-23201      L1110G-6320      L1110G-73082      L1110G-8320      L1100G-23201      L1100G-6320

**NISSAN :**

23230-0L700

**Unit no.**

HITACHI

LR1100-703B      LR1100-711      LR1100-711B      LR1100-725      LR1100-725B      LR1100-725C

LR1110-707F      LR1110-707G      LR1110-707H      LR1110-709B      LR1110-710F

NISSAN

23100-L701

**RH-78**

- \*114mm OD
- \*M5 Battery Post
- \*6-35 Amp Diodes

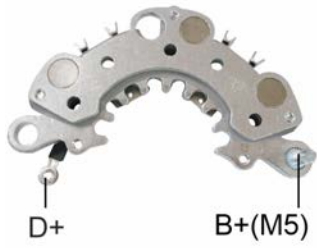

Unit no.   
 KIA   
 OK012-18300    OK241-18300

**RH-79**

- \*110mm OD
- \*M6 Battery Post
- \*6-50A Avalanche Diodes
- \*w/o Diode Trios

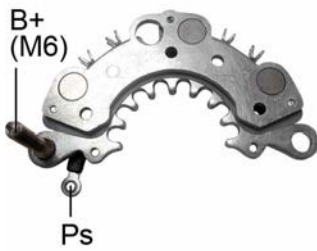

Replaces   
 HITACHI :   
 LR160-729C

**RH-80**

- \*M6 Battery Post
- \*8-35A Avalanche Diodes

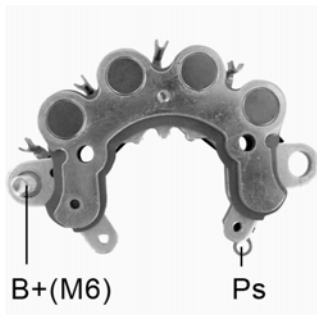

Unit no.   
 HITACHI   
 LR165-713

**RH-82**

- \*114mm OD
- \*M6 Battery Post
- \*8-35 Amp Diodes

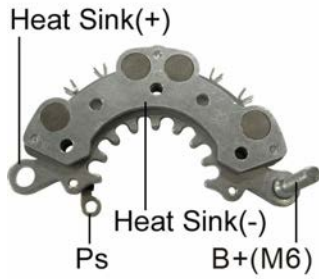

**Replaces**

HITACHI :  
234829

**Unit no.**

HITACHI  
LR190-744  
ISUZU  
29027-68300      89720-43320

**RH-83**

- \*114mm OD
- \*M6 Battery Post
- \*8-50A Avalanche Diodes

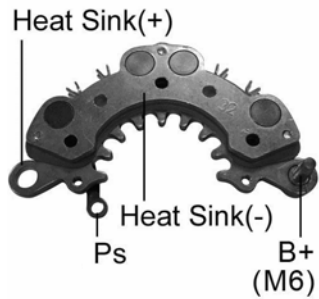

**Unit no.**

HITACHI  
LR190-742  
SUBARU  
23700-AA31A

**RH-85**

- \*120mm OD
- \*M8 Battery Post w/o diode Trio
- \*6-50A Avalanche Diodes

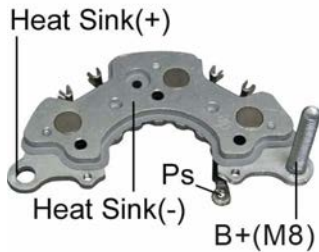

**Unit no.**

HITACHI  
LR1100-502MD

**RH-91**

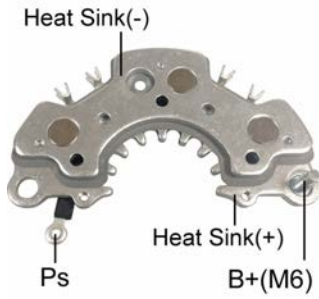

- \*120mm OD
- \*M6 Battery Post
- \*6-35A Avalanche Diodes

Unit no.

HITACHI  
 LR1110-713V      LR1110-713C  
 NISSAN  
 23100-JA02C      23100-AU400      23100-AU40D

Used On

**NISSAN**  
 Rouge 4Cyl. 2.5L 2008-2012

**RH-92**

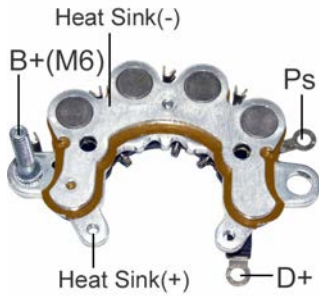

- \*95mm OD
- \*M6 Battery Post w/diode trio
- \*8-50 Amp Diodes

Unit no.

HITACHI  
 LR160-735B      LR160-735  
 YANMAR  
 123900-77210

**RH-93**

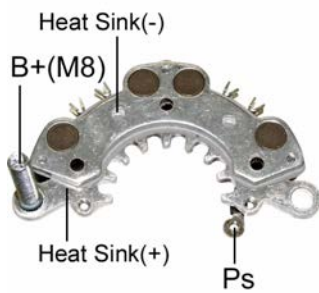

- \*114mm OD
- \*M8 Battery Post
- \*8-35 Avalanche Diodes

Unit no.

HITACHI  
 LR1100-715

**RH-94**

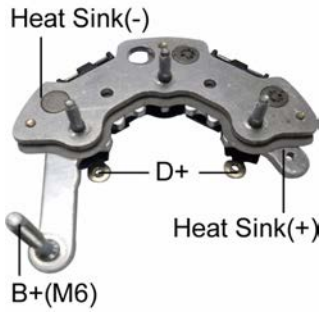

- \*119mm OD
- \*M6 Battery Post w/ diode Trio
- \*6-50 Amp Diodes

Unit no.   
 NISSAN  
 23100-0T002

**RH-95**

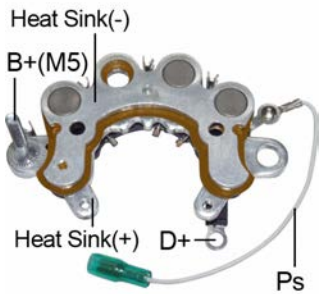

- \*95mm OD
- \*M5 Battery Post
- \*6-35 Amp Diodes

Unit no.   
 HITACHI  
 LR140-721      LR140-721B      LR140-721C  
 YANMAR  
 129612-77230

**RH-97**

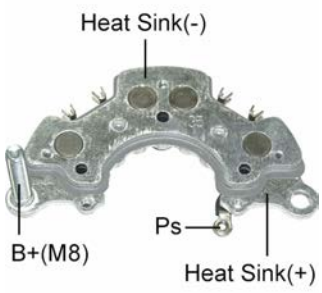

- \*119mm OD
- \*M8 Battery Post w/diode Trio
- \*8-35A Avalanche Diodes

Unit no.   
 HITACHI  
 LR1110-504

**RV-H001**

\*Complete set with VR-H2000-53 + RH-72



Unit no.

HITACHI  
LR170-505

**RV-H002**

\*Complete set with VR-H2000-50 + RH-73



Unit no.

HITACHI					
LR1100-502E	LR1100502	LR1100502B	LR1100502F	LR1100502G	LR1100502J
LR1100502K	LR1100502L	LR1100504C	LR1100504E		
ISUZU					
897181891130	8971891133	8971891134	8971891135	8971891136	8971891137
8971891138	8972873923	97189113			
VAUXHALL					
1204158	6240140	9312785	93175799	93175944	97189113

**RV-H003B**

\*24V  
\*Complete set with VR-H2000-86B + RH-74



Unit no.

HITACHI		
LR250-502C	LR250-507	LR250-507C
ISUZU		
8-97075-883-2	8-97148-496-0	8-97148-496-1



**RV-H004**

\*Complete set with VR-H2000-57 + RH-80



Unit no.

HITACHI  
LR165-713

**RV-H005A**

\* Complete set with VR-H2000-29A-2+ RH-04N  
\* Voltage regulator with capacitor



Unit no.

HITACHI  
LR150-431

**RV-H005BA**

\* 24V  
\* Complete set with VR-H2000-29BA-2 + RH-04N  
\* Voltage regulator with capacitor



Unit no.

HITACHI  
LR270-05

**RV-H008**

\*Complete set with VR-H2000-64 + RH-85



Unit no. [REDACTED]

HITACHI

LR1100-502MD

**RV-H009**

\*Complete set with VR-H2000-24 + RH-28



Unit no. [REDACTED]

HITACHI

LR150-711

**RV-H013**

\*Complete set with VR-H2000-65 + RH-58C



Unit no. [REDACTED]

HITACHI

LR180-502R

**RV-H017B**



\*24V  
 \*Complete set with VR-H2000-70B + RH-111

Unit no.

HITACHI		
LR280-501	LR280-506	LR280-508
ISUZU		
8-97351-574-0	8-97248-914-1	8-97332-502-0

**RV-H022**



\*Complete set with VR-H2000-72 + RH-92

Unit no.

HITACHI	
LR160-735	LR160-735B
YANMAR	
123900-77210	

**RV-H023**



\*Complete set with VR-H2000-74 + RH-93

Unit no.

HITACHI	
LR1100-715	

**RV-H024B**

\*24V  
 \*Complete set with VR-H2000-75B + RH-94



Unit no. [redacted]  
 NISSAN  
 23100-0T002

**Used On** [redacted]  
**NISSAN**  
 Cabstar  
 MK120

1997-

**RV-H025**

\*Complete set with VR-H2000-89 + RH-102



Unit no. [redacted]  
 HITACHI  
 LR1130-703      LR1130-703A      LR1130-703B  
 NISSAN  
 23100-EA200      23100-EA20A

**RV-H030**

\*Complete set with VR-H2000-64+RH-73



Unit no. [redacted]  
 HITACHI  
 LR1100-508  
 ISUZU  
 89736-95070

**Used On** [redacted]  
**OPEL**  
 Astra 1.7L

2004-on

**RV-H034**

\*Complete set with VR-H2000-44 + RH-69



**Unit no.**

HITACHI  
LR1100-722  
NISSAN  
23100-5M000

**Used On**

**NISSAN**  
Sentra 1.8L 2000-2001

**RV-H036**

\*Complete set with VR-H2000-27+RH-65



**Unit no.**

HITACHI  
LR160-728 LR160-728C  
NISSAN  
23100-7T402

**RV-H040**

\*Complete set with VR-H2000-28 + RH-35



**Replaces**

**HITACHI :**  
L1100G-3340 L1100G-9340  
**NISSAN :**  
23215-31U05

**Unit no.**

HITACHI  
LR1110-705  
NISSAN  
23100-31U01 23100-31U02

**RV-H046**

\*Complete set with VR-H2000-42 + RH-32



Unit no.

HITACHI

LR160-727

LR180-744

**RV-H047**

\*Complete set with VR-H2000-84 + RH-91



Unit no.

HITACHI

LR1110-713V

NISSAN

23100-AU400

**Used On**

**NISSAN**

X-Trail 4 Cyl 2.5L

2005-2006

Primera 2000

2002-2010

Primera 2000 16V

2002-2010

**RV-H049B**

\*24V

\*Complete set with VR-H2000-70B + RH-115



Unit no.

HITACHI

LR280-708B

**RV-H050**

\*Complete set with VR-H2000-44 + RH-70



Unit no.

HITACHI

LR170-757B      LR170-757BR      LR170-765

NISSAN

23100-3S500      23100-3S500R      23100-3S501

Used On

**NISSAN**

Frontier L4 2.4L

1998-2000

Xterra L4 2.4L

2000-2001

**RV-H052B**

\*24V

\*Complete set with VR-H2000-80B + RH-116 (M6 B+)



Unit no.

HITACHI

LR250-508

**RV-H053B**

\*24V

\*Complete set with VR-H2000-80B + RH-117 (M8 B+)



Unit no.

HITACHI

LR250-707

**RV-H055N**

\*Complete set with VR-H2000-30+ RH-15N



Unit no.

HITACHI

LR170-406B

LR160-422B

**RV-H057B**

\*24V

\*Complete set with VR-H2000-92B + RH-119



Unit no.

HITACHI

LR250-517

**RV-H077B**

\*24V

\*Complete set with VR-H2000-76B + RH-121



Unit no.

HITACHI

L250G-13081



**RV-H078**

\*Complete set with VR-H2000-71 + RH-123



Unit no.

HITACHI

LR160-503E

LR160-502E

LR180-512

ISUZU

89724-02702

**RV-H083B**

\*24V

\*Complete set with VR-H2000-94B + RH-116



Unit no.

HITACHI

LR250-511

**RK-04**

Heat Sink(-)

- \*117mm OD
- \*8-50A Avalanche Diodes
- \*M8 Battery Post

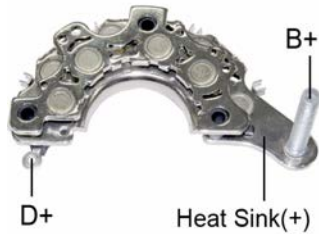

**Unit no.**

HYUNDAI	
37300-27011	37300-27013
POONG SUNG	
02131-9113	02131-9111

**Used On**

**HYUNDAI**

Elantra 2.0L 16V	2001-
Santa FE 2.0L 16V	2001-
Tuscon 2,0L	2004-

**KIA**

Carena 2.0L	2002-
Sportage 2.0L	2005-

**RK-05**

Heat Sink(-)

- \*117mm OD
- \*8-50A Avalanche Diodes

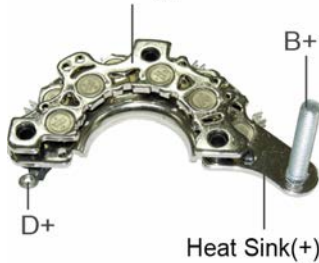

**Replaces**

**POONG SUNG :**  
RES14703

**Unit no.**

HYUNDAI	
37300-27010	37300-27012
POONG SUNG	
02131-9112	02131-9110

**RM-191H**

- \*100mm Mtg. Length
- \*8-30 Amp Diodes

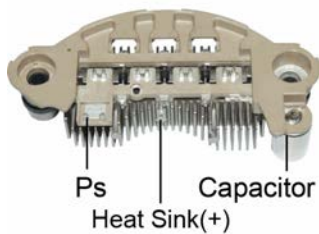

**RM-197**

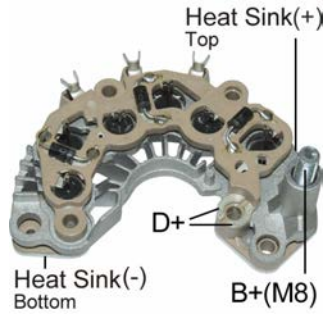

- \*115mm OD
- \*M8 Battery Post
- \*6-50A Avalanche Diodes

Unit no.

HYUNDAI  
37300-23720

**RP-56**

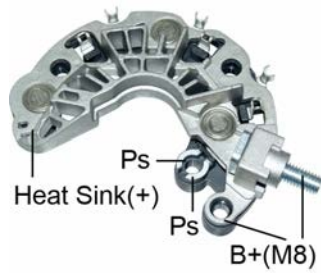

- \*103mm OD
- \*M8 Battery Post
- \*3-50A Avalanche Diodes
- \*Positive rectifier

Unit no.

HYUNDAI  
37300-2B300      37300-2E200  
VALEO  
37300-2B500

**Used On**

**HYUNDAI**

I20	2011-2012
Accent L4 1.6L	2012-2012
Veloster L4 1.6L	2012-

**KIA**

Ceed 1.6i	G4FC	2009-2013
Rio L4 1.6L		2012-2013

**RV-K002**

\*Complete set with VR-K05+ RK-04



Unit no.

HYUNDAI  
37300-27013

Used On

**HYUNDAI**

Elantra 2000	2002-2004
Santa Fe 2000	2001-2010
Trajet 2000	2001-2007
Tucson 2000	2000-2010

**KIA**

Carens 2000	2002-2006
Sportage 2000	2004-2010

**RV-K003**

\*Complete set with VR-K05+ RK-05



Unit no.

HYUNDAI	
37300-27010	37300-27012
POONG SUNG	
02131-9110	02131-9112

**RK-01**

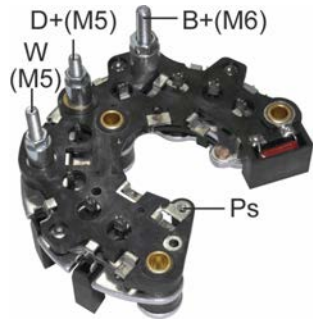

\*M6 Battery Post  
 \*8-50A Avalanche Diodes  
 \*w/diode trio

**Replaces**

ISKRA :  
 16903507

Unit no.

ISKRA					
11201597	11201666	11201667	11201675	11201758	AAK5114
AAK5115	AAK5118	AAK5132			

**RK-02**

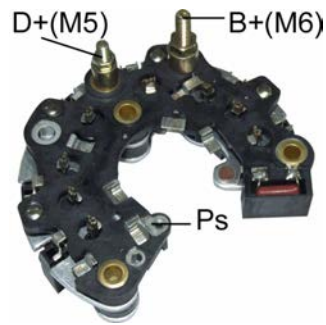

\*M6 Battery Post  
 \*8-50A Avalanche Diodes  
 \*w/ diode trio

**Replaces**

ISKRA :  
 16903314

Unit no.

ISKRA	
11201440	11201490

**RK-06**

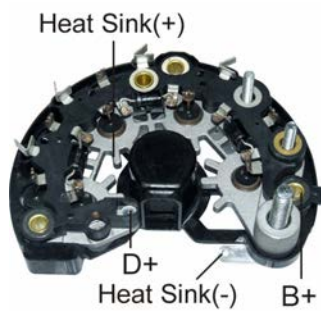

\*8-50A Avalanche Diodes

Unit no.

LETRIKA (ISKRA)	
AAN8167	AAN5806
PERKINS	
2871A903	

**RC-01HV**



- \*6-50 Amp Diodes
- \*Positive
- \*4884J
- \*4806J
- \*4900J

**Replaces**

LEECE NEVILLE :  
101387            A051101387

**RC-02HV**



- \*6-50 Amp Diodes
- \*Positive
- \*4884J
- \*4860J
- \*4900J

**Replaces**

LEECE NEVILLE :  
101441            A051101441            101411

**Unit no.**

LEECE NEVILLE					
4830LC	4830LCRM	4836AAH	4860J	4860JB	4884J
4884JB	4900J	4900JB	4900JBS	90771	A001090771
A0014830LC	A0014836AAH	A0014860JB	A0014860JBH	A0014884J	A0014884JB
A0014900JB	A0014900JBS				

**RC-03H**

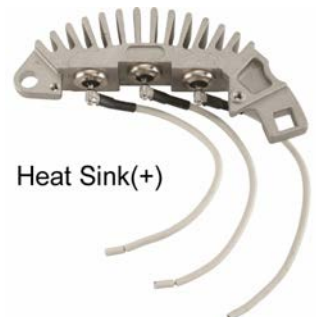

- \*6-35 Amp Diodes
- \*Positive
- \*JA Series Alternators
- \*JB Series Alternators

**Replaces**

LEECE NEVILLE :  
71180

**RC-04H**



Heat Sink(-)

- \*6-35 Amp Diodes
- \*Negative
- \*JA Series Alternators
- \*JB Series Alternators

**Replaces**

LEECE NEVILLE :  
71181

**RC-05HV**



Heat Sink(+)

- \*6-50 Amp Diodes
- \*Positive
- \*J, JB Series Alternators

**Replaces**

LEECE NEVILLE :  
79193

**RC-06HV**



Heat Sink(-)

- \*6-50 Amp Diodes
- \*Negative
- \*J, JB Series Alternators

**Replaces**

LEECE NEVILLE :  
79415

**RC-07HV**



Heat Sink(+)

- \*6-50 Amp Diodes
- \*Positive
- \*2800JB
- \*7804-7808 J Series Alternators

**Replaces**

LEECE NEVILLE :  
97084

**RC-08HV**



- \*6-50 Amp Diodes
- \*Negative
- \*2800JB
- \*7804-7808 J Series Alternators

**Replaces**

LEECE NEVILLE :  
97085

**RC-17HD**



- \*6-70 Amp Diodes
- \*Negative
- \*4800 Series Alternator

**Unit no.**

LEECE NEVILLE  
A0014834LC

**RC-18HD**



- \*6-70 Amp Diodes
- \*Positive
- \*4800 Series Alternator

**Unit no.**

LEECE NEVILLE  
A0014834LC



**RL-01H**

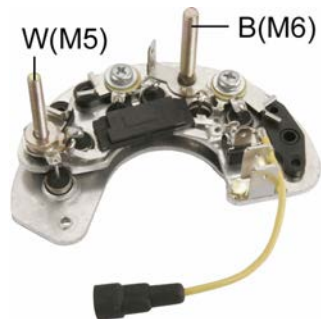

- \*115mm OD
- \*M6 Battery Post
- \*6-35 Amp Diodes

**Replaces**

**CASE :**

K262267

**FORD :**

E7NN-10304AA

**LUCAS :**

84201	84422	84454	84455	84499	UBB133
UBB135	UBB141	UBB143	84454010	84499010	84885010
66201570	84457	84855	84885	84889	UBB144

**MAGNETI MARELLI :**

84454

**MASSEY FERGUSON :**

1897700M91      3474648M91      3477529M91

**PERKINS :**

28710253

**ROVER :**

BAU4920      BAU5266      BAU5813      RTC5045

**RVI :**

5430021884

**Unit no.**

**LUCAS**

24145	24156	24157	24158	24161	24169
24198	24199	24200	24208	24209	24228
24231	24232	24240	24241	24242	24245
24246	24249	24256	24273	24274	

**RL-02H**

\*115mm OD  
\*6-35 Amp Diodes

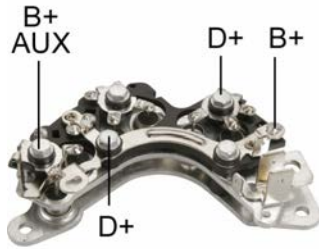

**Replaces**

**CASE :**

245537C1

**FIAT :**

9937250

**FORD :**

81AB-10304AA    81DB-10304BA    82BB-10304AA    E3NN-10304AA

**LUCAS :**

83563	83642	83643	84719	84758	84759
UBB115	UBB122	UBB129			

**MASSEY FERGUSON :**

1897267M1

**PERKINS :**

28710225                      28710236

**ROVER :**

BAU1825L

**RVI :**

5430020198                  5430020791

**Unit no.**

LUCAS

23983	23984	23985	23986	24023	24024
24026	24027	24028	24035	24036	24037
24051	24052	24058	24059	24061	24062
24063	24064	24065	24066	24082	24083
24085	24087	24092	24094	24095	24099
24112	24131	24132	24134	24135	24144
24147	24170	24179	24180	24181	24182
24183	24184	24185	24210	24211	24237

**RL-03H**

\*115mm OD  
\*M6 Battery Post  
\*6-35 Amp Diodes

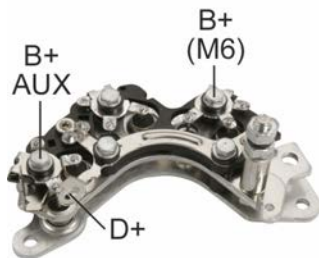

**Replaces**

**LUCAS :**

83565	83670	83757	83784	84760	84761
UBB117	UBB120	UBB124			

**Unit no.**

LUCAS

24041	24060	24167	24168	24171	60921062
-------	-------	-------	-------	-------	----------

**RL-04H**

\*115mm OD  
\*6-35 Amp Diodes

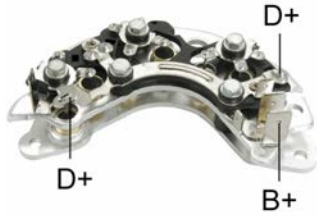

**Replaces**

**FORD :**

81AB-10304BA    81AB-10304CA

**LUCAS :**

83567                    83623                    83645                    84720                    84767                    UBB116  
UBB121                    UBB127

**MASSEY FERGUSON :**

1895344M1            1897344M1

**PERKINS :**

28710243

**ROVER :**

BAU1996                    BAU2191                    RTC3213

**Unit no.**

**LUCAS**

23996	23997	23998	23999	24020	24025
24034	24053	24054	24067	24069	24070
24071	24072	24079	24086	24088	24089
24090	24096	24098	24114	24115	24116
24117	24118	24119	24128	24136	24137
24149	24151	24153	24164	24165	24177
24178	24189	24190	24191	24192	24204

**RL-05H**

\*115mm OD  
\*6-35 Amp Diodes

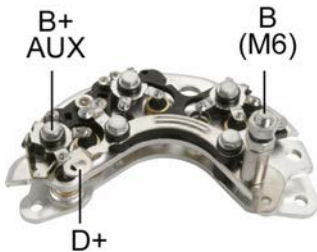

**Replaces**

**LUCAS :**

83569                    83571                    84765                    UBB118                    UBB126

**MASSEY FERGUSON :**

3475823M1

**ROVER :**

AEU1527                    AEU1527J

**Unit no.**

**LUCAS**

23969	24010	24011	24046	24047	24055
24091	24093	24100	24125	24126	24127

**RL-06H**

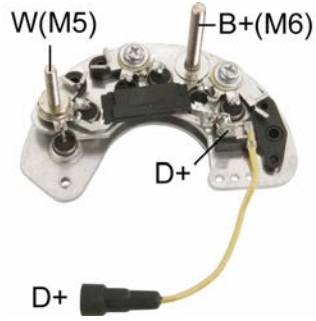

- \*115mm OD
- \*M6 Battery Post
- \*6-35 Amp Diodes

**Replaces**

**FORD :**

864F-10304AA

**LUCAS :**

84456	84456010	84486	UBB140
-------	----------	-------	--------

**Unit no.**

**LUCAS**

24188	24213	24230	24264
-------	-------	-------	-------

**RL-07H**

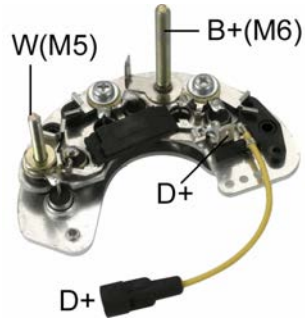

- \*115mm OD
- \*M6 Battery Post
- \*6-35 Amp Diodes

**Replaces**

**LUCAS :**

84888	UBB147
-------	--------

**Unit no.**

**LUCAS**

24255	24287
-------	-------

**RL-08HV**

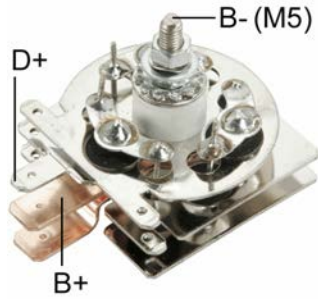

\*115mm OD  
\*9-35 Amp Diodes

**Replaces**

**BL/JAGUAR :**

37H6913                      607688                      90607688                      JS486                      UKC1662

**FORD :**

69EB-10304AA              D4NN-10304A

**LUCAS :**

83166(4DS5)              83334(4DS8)              83520                      83842(4DS7)              83844                      84443

UBB109(4D45)              UBB110(4DS7)

**MASSEY FERGUSON :**

1429443M1                      1888323M1                      1897094M1                      3474574M1

**TALBOT :**

75061613

**Unit no.**

**LUCAS**

23589	23590	23591	23592	23593	23605
23606	23615	23616	23617	23618	23619
23620	23622	23623	23632	23646	23647
23648	23653	23654	23659	23673	23675
23677	23679	23682	23685	23691	23692
23694	23695	23699	23700	23701	23702
23703	23704	23705	23706	23707	23708
23709	23711	23712	23713	23714	23715
23716	23717	23718	23719	23721	23723
23724	23725	23726	23727	23728	23729
23730	23731	23734	23735	23736	23737
23738	23739	23740	23743	23751	23752
23753	23754	23755	23758	23759	23760
23761	23762	23765	23766	23767	23768
23769	23770	23771	23773	23774	23775
23777	23779	23781	23782	23794	23799
23800	23801	23802	23807	23808	23809
23810	23811	23813	23814	23819	23828
23830	23831	23837	23839	23840	23841
23842	23846	23847	23848	23850	23851
23852	23853	23854	23855	23856	23857
23860	23865	23871	23873	23878	23879
23880	23888	23889	23891	23893	23896
23903	23904	23905	23906	23909	23910
23911	23912	23913	23914	23915	23916
23917	23918	23919	23920	23921	23922
23923	23924	23925	23926	23927	23928
23929	23943	23944	23945	23946	23947
23948	23949	23950	23962	23963	23989
23990	23991	23993	23994	24012	24014
24019	24022	24048	24103	24108	24123
24139					

**RL-09H**

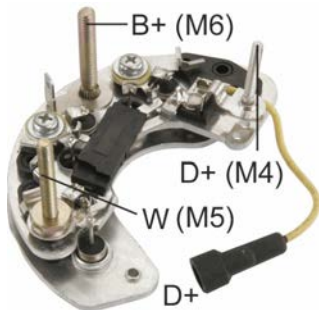

\*115mm OD  
\*6-35 Amp Diodes

**Replaces**

**FORD :**

86AB-10304BA

**LUCAS :**

84469	UBB137	84469010	84886010	84469	84886
UBB137	80367	80150	84886		

**MAGNETI MARELLI :**

000000028502	000000084469	000000084886	000028502010	000084469010	28502
--------------	--------------	--------------	--------------	--------------	-------

**ROVER :**

LBU5225	RTC5371	RTC5671
---------	---------	---------

**Unit no.**

LUCAS					
24206AB	24207	24207A	24216	24217	24217A
24220	24220A	24221	24221A	54022159	LRA461
LRA517	LRA604				

**RL-10H**

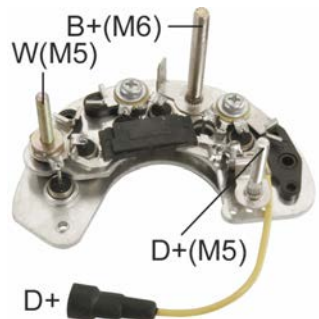

\*115mm OD  
\*M6 Battery Post  
\*6-35 Amp Diodes

**Replaces**

**LUCAS :**

28500010	28506010	84976
----------	----------	-------

**MAGNETI MARELLI :**

63328506	28500	28506
----------	-------	-------

**Unit no.**

LUCAS  
24286  
NISSAN  
23100-71J00

**RL-11H**

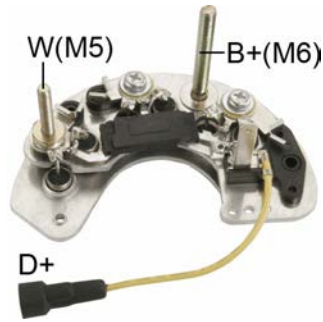

- \*115mm OD
- \*M6 Battery Post
- \*6-35 Amp Diodes

**Replaces**

**LUCAS :**  
84468                      UBB136

**Unit no.**

LUCAS  
24203                      24214

**RL-12H**

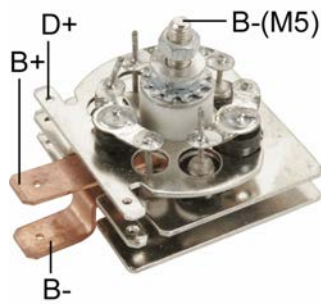

- \*9-35 Amp Diodes

**Replaces**

**BL/JAGUAR :**  
37H6924                      606829

**FORD :**  
692F-10304AA

**LUCAS :**  
83062                      83178                      83192                      84125                      84460                      UBB108  
83962

**TALBOT :**  
5059884

**VAUXHALL :**  
2698242

**Unit no.**

LUCAS

23544	23548	23554	23555	23562	23563
23565	23566	23568	23570	23572	23573
23574	23575	23576	23581	23582	23583
23584	23585	23595	23597	23598	23599
23600	23602	23603	23624	23625	23626
23627	23629	23630	23631	23634	23635
23636	23637	23638	23639	23640	23641
23642	23643	23644	23645	23649	23650
23652	23653A	23655	23656	23658	23660
23661	23662	23663	23664	23665	23666
23667	23668	23676	23678	23696	23741
23742	23778	23780	23816	23820	23822
23823	23824	23825	23826	23827	23874
23890	23961				

**RL-13**

\*9-25 Amp Diodes

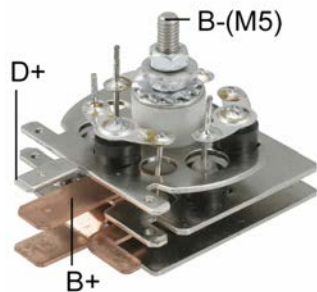

**Replaces**

**BL/JAGUAR :**

37H7965            RTC1004            UKC1657

**LUCAS :**

83295            84124            84459            UBB111

**Unit no.**

LUCAS

23745            23747            23748            23750            23793            23795

23796            23797            23804            23818            23843            23844

23845

**RL-13H**

\*M5 Battery Post

\*9-35 Amp Diodes

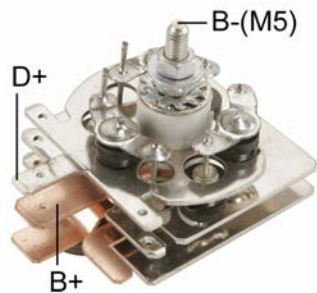

**Replaces**

**BL/JAGUAR :**

37H7965            RTC1004            UKC1657

**LUCAS :**

83295            84124            84459            UBB111

**Unit no.**

LUCAS

23745            23747            23748            23750            23793            23795

23796            23797            23804            23818            23843            23844

23845



**RL-14**

\*9-25 Amp Diodes

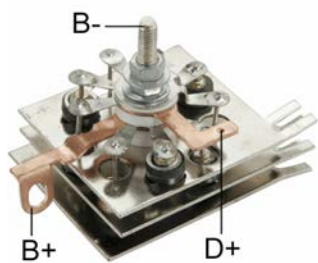

**Replaces**

**LUCAS :**

83442	83633	84718	UBB113
-------	-------	-------	--------

**Unit no.**

LUCAS

23835	23838	23859	23864	23868	23869
23876	23877	23881	23957	23958	23967
24017	24018	24029	24030	24032	24044
24045					

**RL-14H**

\*9-35 Amp Diodes

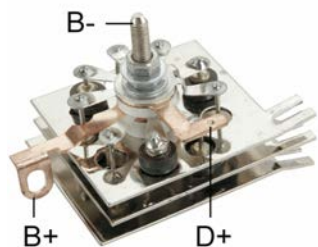

**Replaces**

**LUCAS :**

83442	83633	84718	UBB113
-------	-------	-------	--------

**Unit no.**

LUCAS

23835	23838	23859	23864	23868	23869
23876	23877	23881	23957	23958	23967
24017	24018	24029	24030	24032	24044
24045					

**RL-15**

\*9-25 Amp Diodes

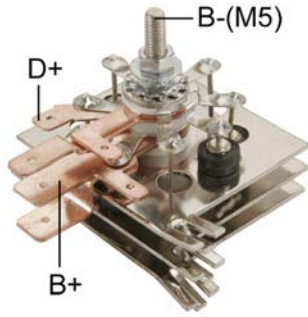

**Replaces**

**BL/JAGUAR :**

AAU8483                      BAU1830

**FORD :**

75AB-10304AA

**LUCAS :**

83452                      83634                      84717                      UBB130

**MASSEY FERGUSON :**

1895097M1

**TALBOT :**

35140800

**VAUXHALL :**

91062513                      91103214

**Unit no.**

LUCAS

23833                      23861                      23862                      23863                      23867                      23882

23883                      23884                      24031

**RL-15H**

\*M5 Battery Post  
\*9-35 Amp Diodes

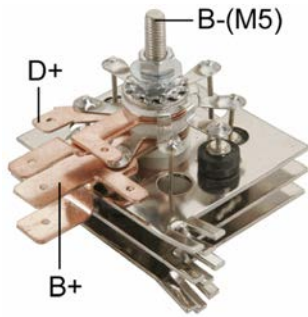

**Replaces**

**BL/JAGUAR :**

AAU8483                      BAU1830

**FORD :**

75AB-10304AA

**LUCAS :**

83452                      83634                      84717                      UBB130

**MASSEY FERGUSON :**

1895097M1

**TALBOT :**

35140800

**VAUXHALL :**

91062513                      91103214

**Unit no.**

LUCAS

23833                      23861                      23862                      23863                      23867                      23882

23883                      23884                      24031

**RL-16**

\*M5 Battery Post  
\*6-25 Amp Diodes

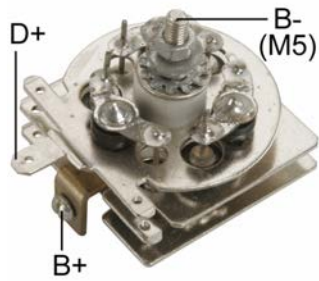

**Replaces**

FIAT :

9935804

LUCAS :

83584

84602

UBB128

Unit no.

FIAT

4423302

LUCAS

23980

**RL-16H**

\*M5 Battery Post  
\*6-35 Amp Diodes

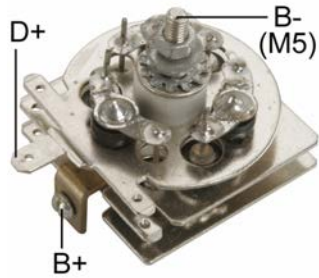

**Replaces**

FIAT :

9935804

LUCAS :

83610231010

83584

84602

UBB128

MAGNETI MARELLI :

83610231

Unit no.

FIAT

4423302

LUCAS

23980

**RL-17H**

\*122 mm OD  
 \*M6 Battery Post  
 \*6-35 Amp Diodes

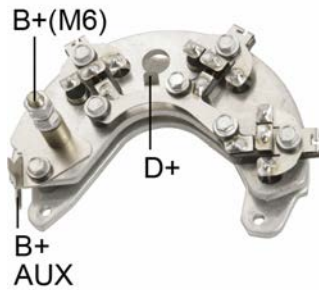

**Replaces**

**LUCAS :**  
 83763                      UBB131  
**VALEO(DUCELLIER) :**  
 593062

**Unit no.**

LUCAS					
23970	23970AB	23971	23971A	24056	24056AB
24101	24101AE	24102	24102AE	24110A	24142
24142AB	24150AD	24150EF	24173	24173A	24176A
24186	24186AB	24201A	24250	24250A	24275A

**RL-20H**

\*9-35 Amp Diodes

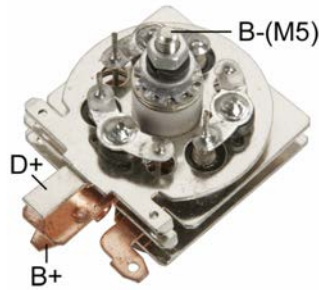

**Replaces**

**LUCAS :**  
 60211170            83320                      UBB112  
**MAGNETI MARELLI :**  
 940038261

**Unit no.**

LUCAS					
23746	23746A	23756AD	23806	23806AB	23832AB
23849	23849A	23892A	LRA129		

**RL-21H**

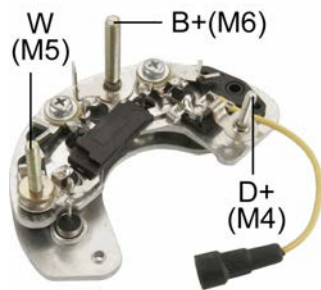

\*115mm OD  
 \*M6 Battery Post  
 \*6-35 Amp Diode

**Replaces**

**FORD :**  
 87BB-10304CA

**LUCAS :**  
 84572                      UBB145                      84572010

**Unit no.**

LUCAS					
24215	24215A	24216A	24224	24236	24257
24257A	24261A	24271	24271A	LRA516	LRA518
LRA521					

**RL-22H**

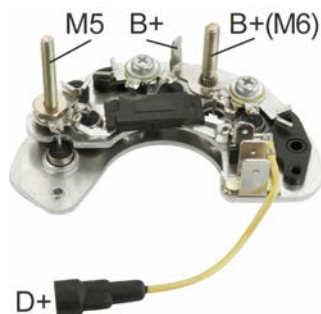

\*115mm OD  
 \*M5 Battery Post  
 \*6-35 Amp Diodes

**Replaces**

**LUCAS :**  
 84574                      UBB138

**NISSAN :**  
 23230-Q9000

**ROVER :**  
 BAU5816

**VALEO :**  
 A559893A

**Unit no.**

LUCAS					
24223A	24235	24235AD	24322A	24356A	54022203
54022238	LRA775				

**RL-23H**

\*6-35 Amp Diodes  
\*M6 Battery Post

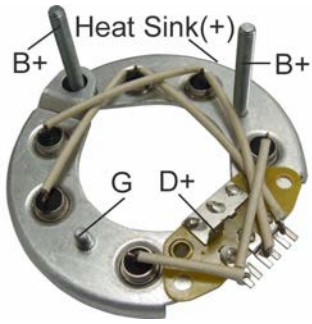

**Replaces**

LUCAS :  
35213274

**Unit no.**

LUCAS  
35213725            35213730

**RI-01HA**

\*W/DIODE TRIO  
\*6-35 Amp Diodes

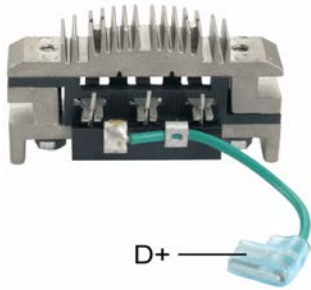

**Replaces**

**FIAT :**

9934595            9934958            9947325

**MAGNETI MARELLI :**

64826011          64826022          64826040          64877471          64878691          74877471  
74878691          PRD4A

**Unit no.**

**FIAT**

4379899            4393206            4395131            4419793            4715786            4738563

5920974

**MAGNETI MARELLI**

63300515	63300905	63300925	63305000	63305020	63305100
63305101	63305120	63305130	63305131	63305206	63305226
63305236	63305300	63305310	63305400	63305401	63305402
63305403	63305420	63305423	63305430	63305431	63305432
63305440	63305506	63305526	63305536	63305601	63305621
63305690	63305700	63305701	63305720	63305721	63305800
63305820	63305920	63306000	63306050	63306060	63306070
63306079	63306089	63306300	63306350	63306360	63306370
63306379	63306389	63306500	63306520	63306700	63306701
63306720	63306721				

**RI-02HA**

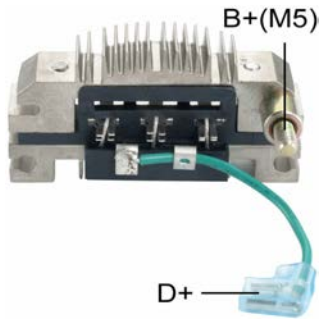

\*W/DIODE TRIO  
\*6-35 Amp Diodes

**Replaces**

**DELCO REMY (LUCAS) :**

21222124

**FIAT :**

9947325

**MAGNETI MARELLI :**

63621501          63621601          RDD15          RDD16

**Unit no.**

FIAT

4808510	4808513	4808517	4808518	5999868	5999869
7541401	7541822	7541823	7542145	7546342	7546343
7546660	7546686	7546759	7547660	7547686	7548004
7552284	7552382	7552458	7552675	7553788	7553853
7554830	7554832	7554833			

MAGNETI MARELLI

63320001	63320002	63320003	63320004	63320005	63320006
63320007	63320008	63320010	63320013	63320015	63320016
63320017	63320018	63320025	63320026	63320028	63321000
63321001	63321002	63321003	63321004	63321005	63321007
63321009	63321010	63321011	63321013	63321019	63321020
63321021	63321022	63321023	63321025	63321036	63321037
63321042	63321056	63321064	63321071		



**RI-04H**

\*6-35 Amp Diodes  
\*110mm OD



**Replaces**

**FEMSA :**  
19326-1

**FIAT :**  
4149607            4149609            4175054

**MAGNETI MARELLI :**  
74953001            74990331            74990341            74999091

**Unit no.**

BOSCH

9-120-330-268    9-120-330-286

FEMSA

A124N            A12M

FIAT

4181511            4378710            4380114            4408631            4474524            4474525

4474557            4474904            4475035            79014078

MAGNETI MARELLI

63301000            63301020            63303000            63303001            63303030            63303300

63304520

**RI-05H**

\*6-35 Amp Diodes  
\*110mm OD



**Replaces**

**BOSCH :**  
9-121-337-319

**FEMSA :**  
25945-1

**FIAT :**  
4474546

**LUCAS :**  
21223056            21223062            UBB601

**MAGNETI MARELLI :**  
74965501            74966611            74966621

**TOSHIBA :**  
6M3

**Unit no.**

BOSCH

9-120-330-288    9-120-330-289

FEMSA

ALB40N88            ALB40N89

MAGNETI MARELLI

63303200            63303202            63303203            63303213            63303220            63303222

63303223            63303240            63303280            63303282            63303290            63303300

63303311            63303380            63303391            63304201

**RI-06H**

\*6-35 Amp Diodes  
\*110mm OD



**Replaces**

**BOSCH :**

9-121-337-321	9-121-337-325	9-121-337-330	9-121-337-332	9-121-337-333	9-121-337-334
9-121-337-335					

**FEMSA :**

25945-10	25945-17	25945-20	25945-21	25945-25	25945-27
25945-3					

**LUCAS :**

UBB602

**MAGNETI MARELLI :**

940038237

**PEUGEOT :**

5722.98

**Unit no.**

**BOSCH**

9-120-331-853	9-120-331-854	9-120-331-863	9-120-331-872
---------------	---------------	---------------	---------------

**FEMSA**

ALP12NR19	ALS12N53	ALS12N54	ALS12N63	ALS12N64	ALS12N72
-----------	----------	----------	----------	----------	----------

ALT12N38

**RI-11H**

\*6-35 Amp Diodes  
\*M6 Battery Post

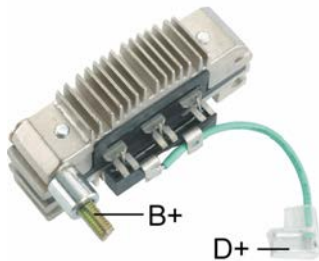

**Replaces**

**MAGNETI MARELLI :**

63622001

**Unit no.**

**MAGNETI MARELLI**

63320042	63320046	63321083	63321084	63321096
----------	----------	----------	----------	----------

**RI-12H**

\*6-35 Amp Diodes  
\*M6 Battery Post

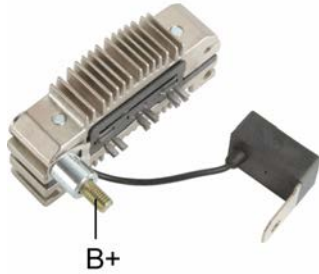

**Replaces**

**MAGNETI MARELLI :**

63022101          RDD346455

**Unit no.**

MAGNETI MARELLI

63322101          63620039

**RI-13H**

\*6-35 Amp Diodes

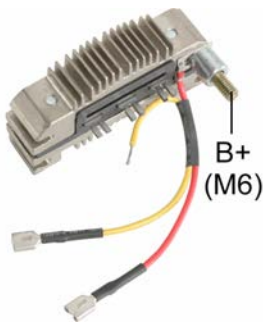

**Replaces**

**MAGNETI MARELLI :**

63622201          RDD22

**Unit no.**

MAGNETI MARELLI

63320041          63321083

**RI-14H**

\*M8 Battery Post  
\*6-50A avalanche Diodes



**Replaces**

**MAGNETI MARELLI :**

63633801          RDD33

**Unit no.**

MAGNETI MARELLI

63321204	63321233	63321234	63321252	63321287	63321330
63321601	63321612	63321618	63321629	63321631	

**RI-15H**

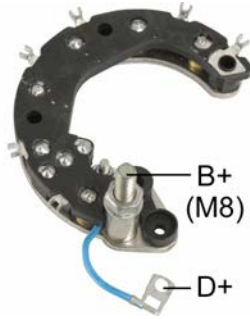

\*M8 Battery Post  
\*6-35 Amp Diodes

**Replaces**

**MAGNETI MARELLI :**  
5402243B

**Unit no.**

MAGNETI MARELLI

63320228	63320289	63320315	63321240	63321243	63321353
63441243					

**RI-16H**

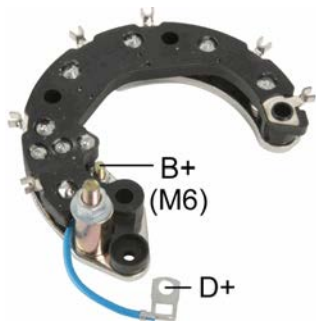

\*M6 Battery Post  
\*6-35 Amp Diodes

**Replaces**

**MAGNETI MARELLI :**  
00084574      54209741

**Unit no.**

MAGNETI MARELLI

54022437	54022459	54022469	54022470	54022510	54022536
54022591	54022606	54022646	54022647	54022651	54022656
63320312	63320313	63320314	63321358	63324320	63324380
63324390					

**RI-17H**



\*M8 Battery Post  
\*6-50A Avalanche Diodes

**Replaces**

**MAGNETI MARELLI :**  
63623601

**Unit no.**

MAGNETI MARELLI

63321353	63321354	63341353	63341354
----------	----------	----------	----------

**RI-18H**



\*M6 Battery Post  
\*6-50A Avalanche Diodes

**Replaces**

**MAGNETI MARELLI :**  
63623602

**Unit no.**

MAGNETI MARELLI

63320281	63320287	63320288	63320289	63320291	63321321
63321351	63321352	63341321	63341333	63341352	63341353

**RI-19H**



\*M8 Battery Post  
\*8-50A Avalanche Diodes

**Replaces**

**MAGNETI MARELLI :**  
63623701

**Unit no.**

MAGNETI MARELLI  
63321240

**RI-21H**

\*M8 Battery Post  
\*6-50A Avalanche Diodes

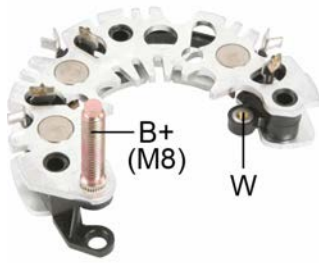

**Replaces**

**MAGNETI MARELLI :**

63623501	63624701	63624801	RDD35	RDD65	RDD75
----------	----------	----------	-------	-------	-------

**Unit no.**

**MAGNETI MARELLI**

63320204	63320227	63320238	63320253	63320257	63320258
63320259	63320261	63320263	63320264	63320265	63320500
63320502	63320503	63320504	63320505	63320506	63320508
63320510	63320511	63320512	63320515	63320519	63320520
63320522	63320530	63320531	63321204	63321205	63321206
63321207	63321208	63321209	63321210	63321211	63321213
63321215	63321235	63321270	63321275	63321276	63321277
63321278	63321280	63321281	63321282	63321283	63321300
63321311	63321361	63321362	63321367	63321396	63321600
63321602	63321603	63321616	63321617	63321620	63321625
63321626	63321632	63321640	63321660	63321661	

**RI-22H**

\*M8 Battery Post  
\*8-50A Avalanche Diodes

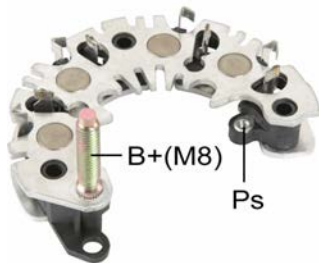

**Replaces**

**MAGNETI MARELLI :**

63623801

**Unit no.**

**MAGNETI MARELLI**

63320255	63320266	63320507	63320509	63320510	63320513
63320521					

**RI-23H**

\*M8 Battery Post  
\*6-50A Avalanche Diodes

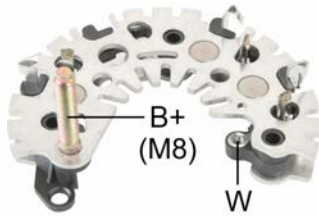

**Replaces**

**MAGNETI MARELLI :**  
63624201

**Unit no.**

MAGNETI MARELLI

63320256	63320277	63320279	63320280	63320283	63320286
63320292	63320296	63320298	63320303	63320304	63320332
63320333	63320338	63320339	63320340	63320341	63320348

**RI-23HD**

\*M8 Battery Post  
\*6-70A Avalanche Diodes  
\*Same as RI-23H but w/ 70 Amp diodes

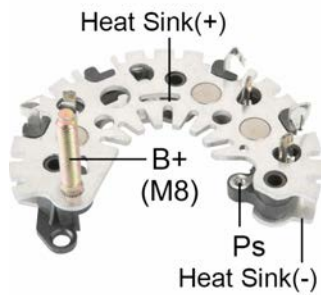

**Replaces**

**MAGNETI MARELLI :**  
63624201

**Unit no.**

MAGNETI MARELLI

63320256	63320277	63320279	63320280	63320283	63320286
63320292	63320296	63320298	63320303	63320304	63320332
63320333	63320338	63320339	63320340	63320341	63320348

**RI-24H**

\*M6 Battery Post  
\*6-50A Avalanche Diodes

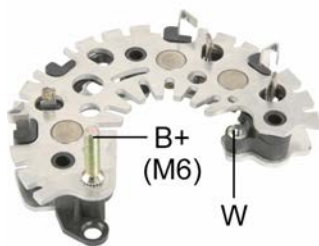

**Replaces**

**MAGNETI MARELLI :**  
63624202

**Unit no.**

MAGNETI MARELLI

63320334	63320335	63320336
----------	----------	----------

**RI-25**

\*M6 Battery Post  
\*6-50A Avalanche Diodes

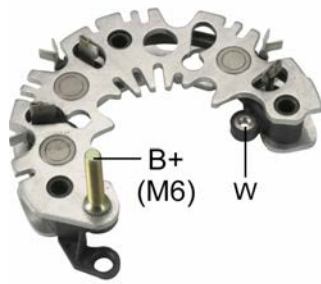

**Replaces**

**MAGNETI MARELLI :**

63624802          RDD75

**Unit no.**

MAGNETI MARELLI

63341238          63341239          63341666

VALEO(PARIS RHONE)

A115I

**RI-26H**

\*8-50A Avalanche Diodes

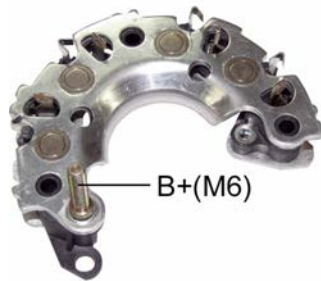

**Replaces**

**MAGNETI MARELLI :**

63321239

**RI-31H**

\*107mm OD  
\*M6 Battery Post  
\*8-50A Avalanche Diodes



**Replaces**

**MAGNETI MARELLI :**

63624103          233534

**Unit no.**

MAGNETI MARELLI

A115I          63321348          63321356          63321692          63321693          63321704  
63321705          63341704          63341705



**RI-32H**

\*M6 Battery Post  
\*6-50A Avalanche Diodes

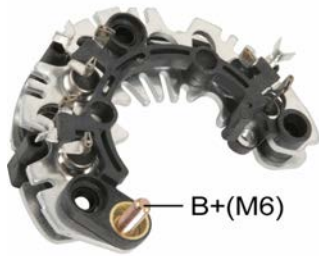

Unit no.

FORD

98AB-10300GC    98AB-10300GD    98AB-10300GE    98AB-10300GF    98AB-10300GG

MAGNETI MARELLI

63321697    63341679    63341697    63321679

**RI-34**

\*6-50A Avalanche Diodes

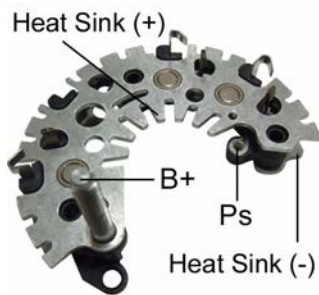

Unit no.

DENSO

102211-8641    102211-8650    102211-8661

**RI-35**

\*M8 Battery Post  
\*6-50A Avalanche Diodes

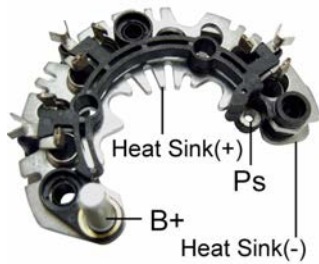

Replaces

MAGNETI MARELLI :

63625002    85552103    85552104    85552105    85552106    85552107  
85552108    85552109    85552110

Unit no.

DENSO

102211-8622

MAGNETI MARELLI

63320500    63320502    63320510    63321287    63321292    63321330  
63321601    63321604    63321605    63321606    63321607    63321608  
63321612    63321615    63321616    63321617    63321744    A115I

OPEL

13256929

**RK-03**

\*8-50A Avalanche Diodes  
\*w/diode trio

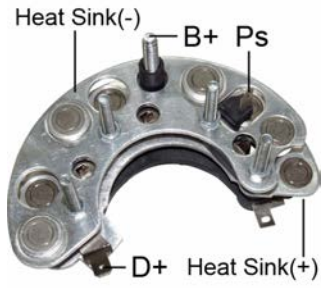

**Replaces**

**MAGNETON-PAL :**

0135940      0135941      0140880      0140881      443930135940

**RM-117**

- \*90mm Mtg. Length
- \*M6 Battery Post
- \*8-30 Amp diodes

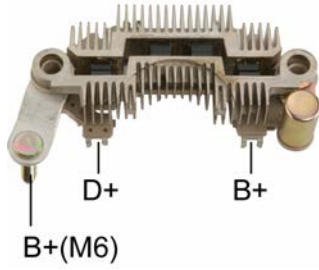

Unit no. [redacted]

HYUNDAI  
37300-22200

**RM-118**

- \*90mm Mtg. Length
- \*M6 Battery Post
- \*6-30 Amp diodes

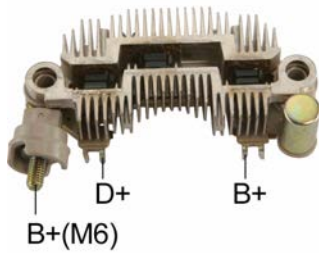

Unit no. [redacted]

HYUNDAI  
AB170094      OK2A2-18300

**RM-123**

- \*108mm OD
- \*6-35 Amp Diodes
- \*w/diode trios



**Replaces**

**VALEO :**  
136738      809162      811875      A600C0231      IMR5005

Unit no. [redacted]

MANDO  
A00B0431      AC15515      AC155515      AC155603      AC165610

**RM-132**

\*M8 Battery Post  
\*6-50A Avalanche Diodes



B+(M8)

**Replaces**

MANDO :  
TA600C13301

**Unit no.**

MANDO  
AB180128

**RM-133**

\*90mm Mtg. Length  
\*M8 Battery Post  
\*8-30A Amp Diodes



B+(M8)

D+

B+

**Unit no.**

HYUNDAI  
37300-38310  
MANDO  
AB195126

**RM-144**

\*M8 Battery Post  
\*8-30 Amp Diodes



B+(M8)

D+

B+

**Unit no.**

MANDO  
AB112112      AB112145

**RM-198**

\*M6 Battery Post  
\*8-30 Amp Diodes

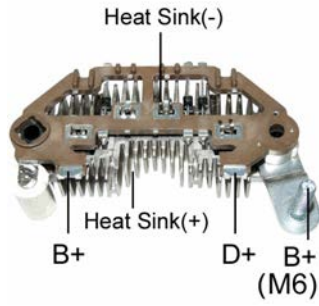

**Unit no.**

HYUNDAI  
37300-22200  
MANDO  
AB190058

**Used On**

**HYUNDAI**

Accent 1.5L	1997-1999
Elantra 1.8L	1996-1998
Elantra 2.0L	1999-2000
Tiburon 1.8L	1997-1998
Tiburon 2.0L	1997-2001

**RM-01HV**



B+(M5)

- \*65mm Mtg. Length
- \*M5 Battery Post
- \*O.E. Compatible Design with 6-50 Amp Diodes
- \*RM-01 With Block Diodes

**Replaces**

**MAZDA :**

FE65-24-510      B101-18-W60      B603-18-W60      E356-18-W60      E356-18-W60A      F881-18-W60  
 FE65-24-510

**MITSUBISHI :**

A860T21770      A860T27870      A860T11970      A860T13370

**MITSUBISHI MOTORS :**

MD607828

**Unit no.**

**FORD**

E7GZ-10346A

**MAZDA**

B603-18-300      B603-18-300A      F356-18-300A      F651-18-300      FE85-18-300      N249-18-300B  
 N304-18-300      N304-18-300B

**MITSUBISHI**

A1T40391      A1T40491      A5T30574      A5T30977      A5T31177      A5T40374  
 A5T41474

**MITSUBISHI MOTORS**

MD069978      MD074992

**RM-02HV**



B+(M5)

- \*65mm Mtg. Length
- \*M5 Battery Post
- \*O.E. Compatible Design with 6-50A Diodes
- \*RM-02 With Block Diodes

**Replaces**

**FORD :**

E7GY-10304A

**MAZDA :**

E356-18-W60      FE65-18-W60      FE65-18-W60A

**MITSUBISHI :**

A860T17470      A860T17870

**Unit no.**

**MITSUBISHI**

A5T16471      A5T30574      A5T30977      A5T31177      A5T41474

**RM-03HV**

- \*65mm Mtg. Length
- \*M6 Battery Post
- \*O.E. Compatible Design with 6-50A Diodes
- \*RM-03 With Block Diodes



**Replaces**

**MITSUBISHI :**  
A860T22770  
**SUBARU :**  
23830-KA070

**Unit no.**

MITSUBISHI  
A1T02592  
SUBARU  
23700-KA190      23700-KA240      23700-KA360

**RM-04HV**

- \*65mm Mtg. Length
- \*O.E. Compatible Design with 6-50 Amp Diodes
- \*RM-04 With Block Diodes

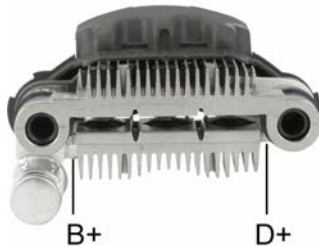

**Replaces**

**MITSUBISHI :**  
A860T16770  
**MITSUBISHI MOTORS :**  
MD611254

**Unit no.**

HYUNDAI  
37700-21030      37700-21320  
MANDO  
AR160A  
MITSUBISHI  
A1T01991      A1T40791      A1T40891  
MITSUBISHI MOTORS  
MD091849      MD091850

**RM-05HV**



B+(M6)

- \*65mm Mtg. Length
- \*M6 Battery Post
- \*O.E. Compatible Design with 6-50 Amp Diodes
- \*RM-05 With Block Diodes

**Replaces**

**MITSUBISHI :**

A860T20570

**NISSAN :**

23124-53A10

**Unit no.**

MITSUBISHI

A5T41592

A5T41592B

NISSAN

23100-53A10

23100-53A11

**RM-06**



B+(M6)

- \*75mm Mtg. Length
- \*M6 Battery Post
- \*6-30 Amp Diodes

**Replaces**

**MITSUBISHI :**

A860T13070

A860T13870

A860T17170

**NISSAN :**

23124-04F10

23124-05P10

23230-04F10

**Unit no.**

MITSUBISHI

A2T45272

A2T45272A

A2T48176

A2T48195A

A2T48195B

NISSAN

23100-04F01

23100-04F10

23100-04F11

23100-05P11

23100-15P11

23100-15P91



**RM-07HV**

- \*75mm Mtg. Length
- \*O.E. Compatible Design with 6-50 Amp Diodes
- \*RM-07 With Block Diodes



**Replaces**

**MITSUBISHI :**

A860T13170      A860T16970      A860T22570      A860T22670

**MITSUBISHI MOTORS :**

MD607917      MD611256      MD611688

**Unit no.**

MITSUBISHI

A2T00991	A2T02271	A2T02471	A2T03471	A2T03477	A2T03691
A2T03792	A2T03972	A2T41791	A2T41991	A2T42777	A2T43791
A2T43891	A2T43892	A2T48691	A2T48791	A2T49891	

MITSUBISHI MOTORS

MD073067	MD074644	MD082419	MD091793	MD091794	MD099624
MD099625	MD102085	MD102088	MD108230	MD108305	MD108509
MD109166	MD109741	MD110318	MD111151	MD111607	

**RM-08HV**

- \*75mm Mtg. Length
- \*M5 Battery Post
- \*O.E. Compatible Design with 6-50 Amp Diodes
- \*RM-08 With Block Diodes



**Replaces**

**FORD :**

E98Z-10304A

**MAZDA :**

E5D3-18-W60A      F811-18-W60      FE79-18-W60

**MITSUBISHI :**

A860T17570      A860T17970      A860T24270

**Unit no.**

MAZDA

B612-18-300A	B617-18-300	FE68-18-300C	HE19-18-300B	N225-18-300A	N245-18-300B
--------------	-------------	--------------	--------------	--------------	--------------

MITSUBISHI

A2T13471	A2T40374	A2T40377	A2T41674	A2T41677	A2T46871
----------	----------	----------	----------	----------	----------

**RM-09HV**

\*75mm Mtg. Length  
 \*O.E. Compatible Design with 6-50 Amp Diodes  
 \*RM-09 With Block Diodes



**Replaces**

**MITSUBISHI :**  
 A860T17270      A860T17285  
**NISSAN :**  
 23124-08E16

**Unit no.**

MITSUBISHI					
A2T46395	A2T46395B	A2T48292	A2T48298		
NISSAN					
23100-26E10	23100-26E11	23100-26E60	23100-26E61	23100-D4110	23100-D4410
23100-D4415					

**RM-100**

\*85mm Mtg. Length  
 \*6-30 Amp diodes  
 \*O.E. Compatible



**Unit no.**

MITSUBISHI		
A2T13391C	A2T13391D	A2T13391E

**RM-105**

\*71mm Mtg. Length  
 \*6-35 Amp Diodes

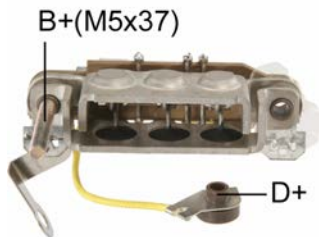

**Replaces**

**MITSUBISHI :**  
 A860T06470

**Unit no.**

MITSUBISHI  
 A1T70379

**RM-10HV**



B+(M6)

- \*75mm Mtg. Length
- \*M6 Battery Post
- \*O.E. Compatible Design with 6-50 Amp Diodes
- \*RM-10 With Block Diodes

**Replaces**

**FORD :**

E8GY-10304B      E92Z-10304A

**MAZDA :**

B675-18-W60      F8B1-18-W60

**MITSUBISHI :**

A860T27170

**Unit no.**

**FORD**

E8GY-10346C      E8GY-10346D      E92Z-10346A

**MANDO**

AB175015      AB175019

**MAZDA**

B675-18-300A      B675-18-300B      F202-18-300      F225-18-300      F262-18-300      F881-18-300A

F88B-18-300B      F8B1-18-300A

**MITSUBISHI**

A2T05772      A2T05892      A2T05893      A2T09493

**RM-11**



- \*75mm Mtg. Length
- \*6-30 Amp Diodes

**Replaces**

**MITSUBISHI :**

A860T17770

**MITSUBISHI MOTORS :**

MD611307

**Unit no.**

**FORD**

E8GY-10346B

**MAZDA**

B655-18-300A

**MITSUBISHI**

A2T03072      A2T03892      A2T09792      A2T13571      A2T49972      A2T49977

**MITSUBISHI MOTORS**

MD106508      MD106713      MD108305      MD117156      MD125569

**RM-110HV**

- \*85mm Mtg. Length
- \*M8 Battery Post
- \*O.E. Compatible Design with 6-50 Amp Diodes

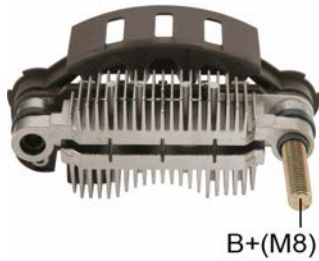

**Replaces**

**MITSUBISHI :**  
A860T57870

**Unit no.**

MAZDA  
Z599-18-300A  
MITSUBISHI  
A2TB0091

**RM-112HV**

- \*85mm Mtg. Length
- \*M5 Battery Post
- \*O.E. Compatible Design with 6-50 Amp Avalanche Diodes

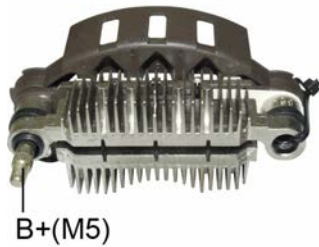

**Unit no.**

MITSUBISHI  
A2TG4891A

**RM-115**

- \*85mm Mtg. Length
- \*M5 Battery Post
- \*8-30 Amp Diodes

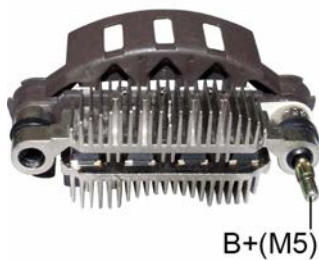

**Unit no.**

MITSUBISHI  
A2TB6291

**RM-116**

- \*100mm Mtg. Length
- \*6-30 Amp Diodes
- \*M8 Battery Post
- \*O.E. Compatible



B+(M8x28)

**Replaces**

**MITSUBISHI :**  
A860X47070

**MITSUBISHI MOTORS :**  
ME701716

**Unit no.**

MITSUBISHI

A3T08699

A3T08799

A3T09698

A3T09699

A3T09799

A3TA3098

A3TA8199

A3TA8199

**RM-119H**

- \*M6 Battery Post
- \*8-35 Amp diodes
- \*\* For Iran Market Only \*\*



B+(M6)

**Replaces**

**KIA :**  
KK137-24-W60

**RM-12**

B+(M5)



- \*75mm Mtg. Length
- \*M5 Battery Post
- \*6-30 Amp Diodes

**Replaces**

**MITSUBISHI :**

A860T20270

**NISSAN :**

23124-58L10

**Unit no.**

FORD

E7GZ-10346A      E804-10346B      E8GY-10346B

HYUNDAI

37900-21030

MAZDA

B601-18-300      B603-18-300      B655-18-300      B665-18-300

MITSUBISHI

86651830      A2T02394      A2T02394B      A2T13571      A2T48472

NISSAN

23100-07F11      23100-12C10      23100-12C11

**RM-120**



B+(M8)

- \*85mm Mtg. Length
- \*M8 Battery Post
- \*W/D+ Terminal, W/Phase Terminal
- \*8-30 Amp Diodes

**Unit no.**

MITSUBISHI

A4T40286      A4T40289      A4T40386      A4TU3085      A4TU3186

MITSUBISHI MOTORS

ME011886      ME077788      ME077789      ME092899      ME093245      ME151974

**RM-124**

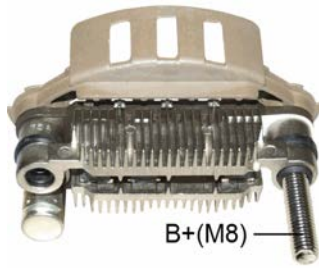

- \*75mm Mtg. Length
- \*M8 Battery Post
- \*6-30 Amp diodes
- \*O.E. Compatible

**Replaces**

**MITSUBISHI :**  
 A860T46570      A860X46570  
**MITSUBISHI MOTORS :**  
 MD618844

**Unit no.**

HYUNDAI  
 37300-02503  
 MANDO  
 AB160108  
 MITSUBISHI  
 A1T06391      A1T06672      A1TA0091      A1TA0291      A1TA0491      A1TA0791  
 A1TA0891  
 MITSUBISHI MOTORS  
 MD300720      MD305885      MD311138      MD311711      MD311712      MD317530  
 MD317531

**RM-125HV**

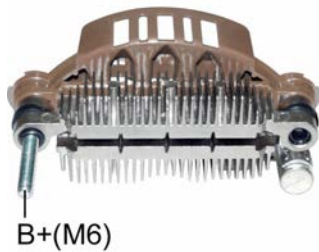

- \*100mm Mtg. Length
- \*M6 Battery Post
- \*O.E. Compatible Design with 8-50 Amp Diodes

**Unit no.**

CHRYSLER  
 4609075

**RM-126**

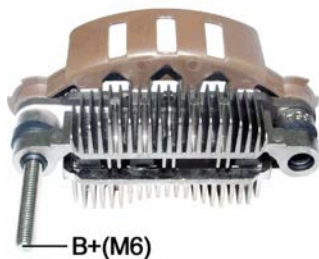

- \*85mm Mtg. Length
- \*M6 Battery Post
- \*6-30 Amp diodes
- \*O.E. Compatible

**Unit no.**

MITSUBISHI  
 A2TB1491      A2TB1941ZC

**RM-127**

- \*100mm Mtg. Length
- \*M6 Battery Post
- \*8-30 Amp diodes
- \*O.E. Compatible



B+(M6)

**Replaces**

**MITSUBISHI :**  
A860X79470

**Unit no.**

MAZDA  
GY011-8300E    GY011-8300R    GY011-8W9XA  
MITSUBISHI  
A3TG2681        A3TB1081

**RM-128**

- \*85mm Mtg. Length
- \*M8 Battery Post
- \*8-30 Amp diodes
- \*O.E. Compatible



B+(M8)

**Unit no.**

MITSUBISHI  
A2TA5391        A2TB5791  
MITSUBISHI MOTORS  
MD317862

**RM-129**

- \*75mm Mtg. Length
- \*M5 Battery Post
- \*6-30 Amp diodes



B+(M5)

**Replaces**

**MITSUBISHI :**  
230261

**Unit no.**

HONDA  
31100-P2EA02    31100-PEJ004  
MITSUBISHI  
A5TA0091        A5TA0991ZC



**RM-129A**



- \*75mm Mtg. Length
- \*M5 Battery Post
- \*6-30 Amp diodes
- \*w/o Trio
- \*w/o Capacitor

**Replaces**

**MITSUBISHI :**  
A860X70970

**Unit no.**

MITSUBISHI		
A5TA3891	A5TA3891A	A5TA4591
SUZUKI		
31400-66D00	31400-66D01	

**RM-130**



- \*85mm Mtg. Length
- \*M5 Battery Post
- \*6-30 Amp Diodes

**Replaces**

**MITSUBISHI :**  
A860X61970

**SUBARU :**  
23830-AA130

**Unit no.**

MITSUBISHI	
A2TA7691	
SUBARU	
23700-AA290	

**RM-131HV**



- \*100mm Mtg. Length
- \*M6 Battery Post
- \*O.E. Compatible Design with 8-50A Diodes
- \*RM-131 With Block Diodes

**Unit no.**

CHRYSLER		
4606075	4609300	
MITSUBISHI		
A3T14292	A3TA4191	A3TA4191ZC

**RM-134**

- \*100mm Mtg. Length
- \*M8 Battery Post
- \*8-30 Amp diodes
- \*O.E. Compatible

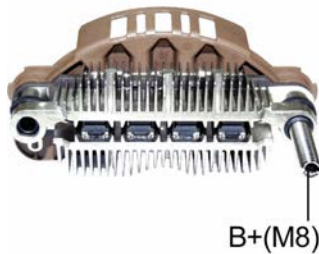

Unit no.

FORD  
 XF52-10300AC    XF5Z-10346AA  
 MITSUBISHI  
 A3TA5691        A3TA5691ZC  
 NISSAN  
 23100-7B000

**RM-135**

- \*85mm Mtg. Length
- \*M6 Battery Post
- \*6-30 Amp diodes
- \*w/o diode trios
- \*O.E. Compatible

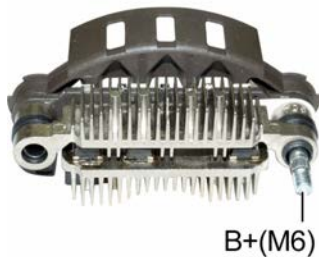

Unit no.

MITSUBISHI  
 A2TB2991

**RM-136**

- \*75mm Mtg. Length
- \*M6 Battery Post
- \*8-30 Amp Diodes

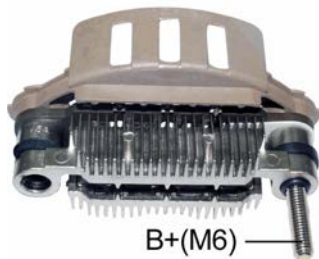

Replaces

**MITSUBISHI :**  
 A860X83370

Unit no.

HONDA  
 31100-PLM-A01    31100-PLM-A012    31100-PLM-C012  
 MITSUBA  
 A5TA7091        A5TA7191

**RM-139**

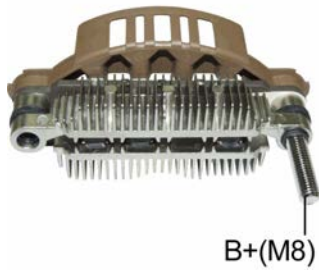

- \*100mm Mtg. Length
- \*6-30 Amp Diodes
- \*M8 Battery Post
- \*O.E. Compatible

Unit no.

MITSUBISHI  
 A3TB3491  
 MITSUBISHI MOTORS  
 MD373093

**RM-14**



- \*75mm Mtg. Length
- \*M6 Battery Post
- \*8-30 Amp Diodes
- \*O.E. Compatible

Replaces

**MITSUBISHI :**  
 A860T27270  
**NISSAN :**  
 23124-77A10

Unit no.

MITSUBISHI  
 A5T00192  
 NISSAN  
 23100-77A10

**RM-143**

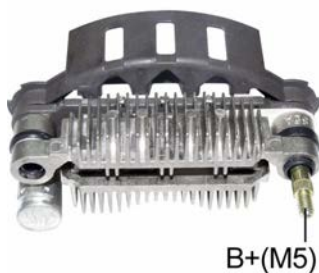

- \*85mm Mtg. Length
- \*M5 Battery Post
- \*6-50 Avalanche Diodes
- \*O.E. Compatible

Unit no.

MITSUBISHI  
 A2TA1991F

**RM-145**



B+(M5)

- \*75mm Mtg. Length
- \*M5 Battery Post
- \*8-30 Amp Diodes
- \*O.E. Compatible

Unit no.

GM

30020754

MITSUBISHI

A5TA2491

A5TA2491ZC

A5TA4291

A5TA4291ZC

**RM-146**



B+(M8)

- \*100mm Mtg. Length
- \*8-30 Amp Diodes
- \*M8 Battery Post
- \*w/ diode trios
- \*O.E. Compatible

Replaces

MITSUBISHI :

A860X61870

Unit no.

MITSUBISHI

A3TA4298

**RM-147**



B+(M6)

- \*75mm Mtg. Length
- \*M6 Battery Post
- \*8-30 Amp diodes
- \*w/ diode trios
- \*O.E. Compatible

Replaces

MITSUBISHI :

A860T30370

Unit no.

MITSUBISHI

A001T03191

A001T04495

A1T03191ZC

**RM-15**

B+  
(M5)

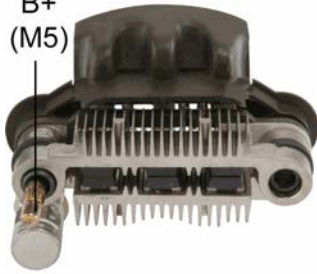

- \*65mm Mtg. Length
- \*M5 Battery Post
- \*6-30 Amp Diodes
- \*O.E. Compatible

**Replaces**

**ECHLIN :**

AC82

**FORD :**

E7GZ-10304A

**HONDA :**

31127-PE0-0340

**LUCAS :**

21513129            UBJ200

**MAGNETI MARELLI :**

940038255

**MAZDA :**

FE65-18-W60A    FE65-24-510

**mitsubishi :**

A860T11970    A860T13370    A860T17470    A860T17870    A860T19870    A860X18371

**mitsubishi MOTORS :**

MD607828

**Unit no.**

**MAZDA**

B603-18-300A    E356-18-300A    F651-18-300    F873-18-300A    FE65-18-300B    FE85-18-300

N249-18-300B    N304-18-300    N304-18-300B

**mitsubishi**

A1T40391    A5T30574    A5T30871    A5T30977    A5T31177    A5T31277

A5T31971    A5T31971A    A5T40374    A5T41474    A5T41477    F65118300C

F87318300B    FE6518300C

**mitsubishi MOTORS**

MD069978    MD074992

**RM-151**

- \*M8 Battery Post
- \*8-50A Avalanche Diodes



B+(M8)

**Unit no.**

**VALEO**

TA000A-48401    TA000A-48402

**RM-152**



- \*85mm Mtg. Length
- \*M8 Battery Post
- \*8-30 Amp Diodes
- \*O.E. Compatible

**Replaces**

**MITSUBISHI :**  
A860X49270

**MITSUBISHI MOTORS :**  
MD618950

**Unit no.**

MITSUBISHI  
A2TN0076      A2TN1199      A2TN1481      A2TN1798      A2TN2476

**RM-153**

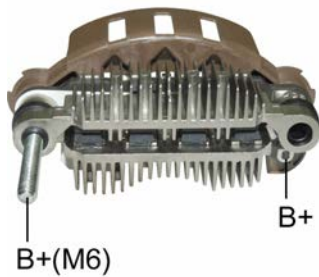

- \*85mm Mtg. Length
- \*M6 Battery Post
- \*8-30 Amp diodes
- \*O.E. Compatible

**Unit no.**

MITSUBISHI  
A2TG0191      A2TG0191ZC

**RM-154HV**

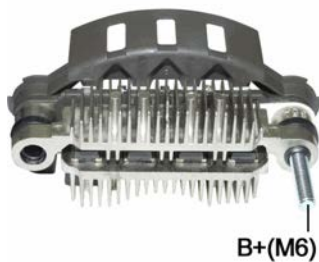

- \*85mm Mtg. Length
- \*M6 Battery Post
- \*O.E. Compatible Design with 8-50A Amp Diodes

**Replaces**

**HONDA :**  
31127-PGM-004

**Unit no.**

HONDA  
31100-PND-004    AHGA53      AHGA55      AHGA65  
MITSUBISHI  
A2TB7951

**Used On**

**HONDA**  
CRV 4Cyl. 2.4L      2002-2006  
Stream      2.0 16V 115kw      2001-

**RM-155HV**

- \*100mm Mtg. Length
- \*M5 Battery Post
- \*O.E. Compatible Design with 8-50A Avalanche Diodes



B+(M5)

Unit no.

CITROEN  
9640088080  
MITSUBISHI  
A3TB2691

Used On

**CITROEN**

C4	1.4L	2004-
C4	2.0L 16V	2004-
C5	2.0L 16V	2001-2004

**PEUGEOT**

307	2.0L 16V	2000-
407	2.2L 16V	2004-
607	2.2L 16V	2000-

**RM-157H**

- \*100mm Mtg. Length
- \*M8 Battery Post
- \*O.E. Compatible Design with 8-35A Diodes



W  
B+(M8)

Replaces

**MITSUBISHI :**  
A860X52670  
**MITSUBISHI MOTORS :**  
ME701570

**RM-158H**

- \*75mm Mtg. Length
- \*M6 Battery Post
- \*O.E. Compatible Design with 6-35A Diodes



B+(M6)

Unit no.

HONDA  
31100-RSH-004  
MITSUBISHI  
A5TB1391

**RM-159**



- \*85mm Mtg. Length
- \*M8 Battery Post
- \*8-30 Amp Diodes

B+(M8)

Unit no.

MITSUBISHI  
A2TG0281  
NISSAN  
23100-DC000

**RM-16**



- \*75mm Mtg. Length
- \*M5 Battery Post
- \*6-30 Amp Diodes
- \*O.E. Compatible

B+(M5)

Replaces

MITSUBISHI :  
A860T27070

Unit no.

MAZDA  
B675-18-300C  
MITSUBISHI  
A2T05772

**RM-161HV**



- \*85mm Mtg. Length
- \*M5 Battery Post
- \*O.E. Compatible Design with 6-50A Diodes

B+(M5)

Unit no.

MITSUBISHI  
A2TG-1081ZT  
NISSAN  
23100-EB71A





**RM-170**

- \*100mm Mtg. Length
- \*M8 Battery Post
- \*8-35 Amp Diodes

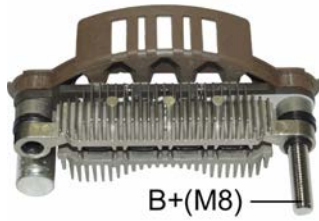

**Replaces**

MITSUBISHI :  
A860X52570

MITSUBISHI MOTORS :  
ME701569

**Unit no.**

MITSUBISHI  
A3T75883      A3TN5188

**RM-175**

- \*115mm OD
- \*M6 Battery Post
- \*12-50A Amp Diodes

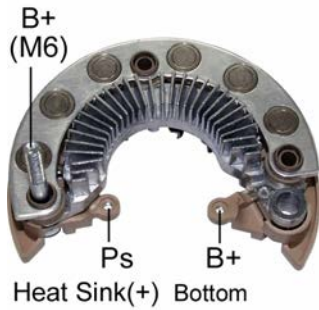

**Unit no.**

HONDA  
AHGA77      31100-RB0-004  
MITSUBISHI  
A5TJ0091

**Used On**

HONDA  
Fit 1.5L

2009-

**RM-176**

- \*75 mm Mtg. Length
- \*M8 Battery Post
- \*8-30 Amp Diodes
- \*O.E. Compatible

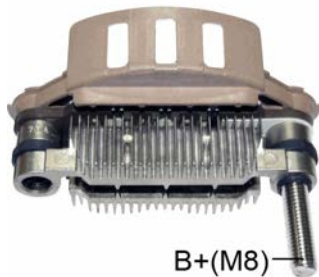

**Unit no.**

MITSUBISHI  
A5TG0091

**RM-178HD**

Heat Sink(-) Top

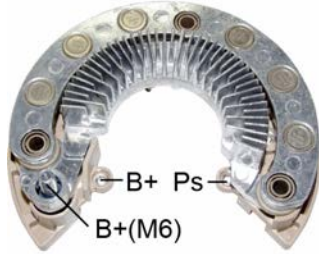

Heat Sink(+) Bottom

- \*122mm OD
- \*M6 Battery Post
- \*12-50A Avalanche Diodes

Unit no.

FORD  
 8S4T-10300AA    8S4Z-10346A  
 MITSUBISHI  
 A2TX0191ZC

Used On

**FORD**

Escape 2.5L	2009 -
Focus 2.0L	2008-2010
Focus 2.3L	2008-2010

**RM-179**

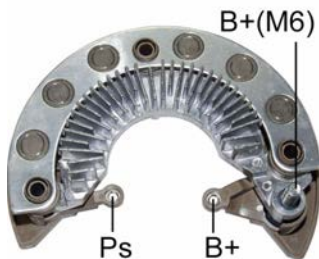

Heat Sink(+) Bottom

- \*130mm OD
- \*M6 Battery Post
- \*12-50A Avalanche Diodes

Replaces

**MITSUBISHI :**  
 94675-C1323-7920†

Unit no.

MITSUBISHI				
A3TJ1791	A3TJ1791ZC	A003TJ3691	A3TJ3691	A3TJ3691ZC
NISSAN				
23100-JA11A	23100-JA11AR	23100-1AA1A	23100-JA11B	

Used On

**NISSAN**

Altima 6Cyl. 3.5L	2007-2013
-------------------	-----------

**RM-18**

\*75mm Mtg. Length  
 \*M5 Battery Post  
 \*6-30 Amp Diodes



**Replaces**

**MITSUBISHI :**  
 A860T19370

**MITSUBISHI MOTORS :**  
 MD611501

**Unit no.**

MITSUBISHI				
A2T01077	A2T01976	A2T17783	A2T49577	
MITSUBISHI MOTORS				
MD099621	MD105606			

**RM-180HV**

\*122mm OD  
 \*M8 Battery Post  
 \*12-50 Amp Diodes

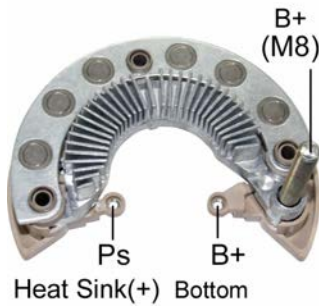

**Unit no.**

MITSUBISHI					
A2TJ0481	A2TJ0481ZC	A002TJ0281	A2TJ0281	A2TJ0281ZC	A2TJ0291
A2TJ0291ZC					
NISSAN					
23100-EM01A	23100-EM01BR	23100-EM01B	23100-JD200	23100-JN81A	

**Used On**

**NISSAN**

Sentra 4Cyl. 2.0L	2007-2010
Versa 4Cyl. 1.8L	2007-2009

**RM-181**

- \*85mm Mtg. Length
- \*M5 Battery Post
- \*8-30 Amp diodes
- \*O.E. Compatible



B+  
(M5)

Unit no.

HONDA  
31100-RNA-A01  
MITSUBISHI  
A2TC1391

Used On

**HONDA**  
Civic 4Cyl. 1.8L

2006-2011

**RM-182**

- \*100mm Mtg. Length
- \*M5 Battery Post
- \*8-35 Amp diodes
- \*O.E. Compatible



B+  
(M5)

Unit no.

MAZDA  
LF1F-18-300  
MITSUBISHI  
A3TG2491      A3TG2491ZC      A3TG4791

Used On

**MITSUBISHI**  
Eclipse 6 Cyl. 3.8L  
Eclipse 6 Cyl. 3.8L  
Galant 6 Cyl. 3.8L  
Galant 6 Cyl. 3.8L  
Endeavor 6 Cyl. 3.8L  
Endeavor 6 Cyl. 3.8L

2006-2010  
2011-2012  
2004-  
2005-2009  
2004-2008  
2010-2011



**RM-187H**

- \*100mm Mtg. Length
- \*M5 Battery Post
- \*8-35 Amp Diodes

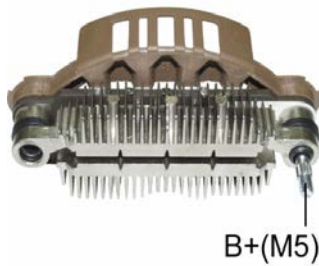

Unit no.   
 FORD  
 2S6T-10300DB    2S6U-10300GB

**RM-189H**

- \*135mm OD
- \*M6 Battery Post
- \*16-50 Avalanche Diodes

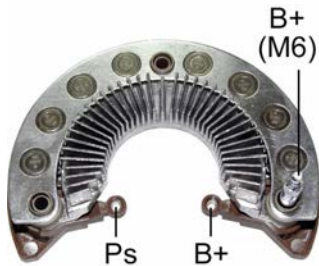

Heat Sink(+) Bottom

**Replaces**   
**MITSUBISHI :**  
 A860T88170

Unit no.   
 FORD  
 4W73-10300AC    4W7Z-10346AC    FW73-10346AC  
 MITSUBISHI  
 A4TJ0181        A4TJ0181ZC

**Used On**   
**FORD**  
 Crown Victoria 4.6L V8 2004-2006

**RM-19**

- \*75mm Mtg. Length
- \*M5 Battery Post
- \*6-30 Amp Diodes



**Replaces**   
**MITSUBISHI :**  
 A860T24570

Unit no.   
 MITSUBISHI  
 A2T03591        A2T03691        A2T03791        A2T03792  
 MITSUBISHI MOTORS  
 MD111151

**RM-190HV**

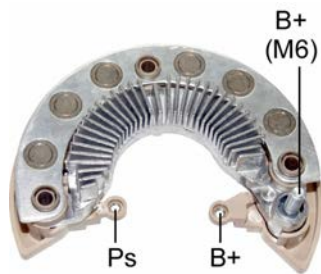

- \*122mm OD
- \*M6 Battery Post
- \*12-50 Amp Diodes

Heat Sink(+) Bottom

Unit no.

MITSUBISHI  
 A2TJ0391      A2TJ0391A      A2TJ0391B      A2TJ0391C

Used On

**MAZDA**

6 2.3L	2006-2008
6 2.5L	2009-
Miata 2.0L	2006-2008

**RM-192**

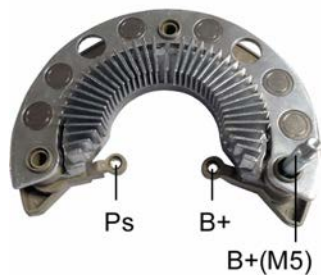

- \*128mm OD
- \*12-50 Amp Diodes
- \*M5 Battery Post

Replaces

MITSUBISHI :  
 A860X85670

Unit no.

MITSUBISHI  
 A3TJ0191

Used On

**MAZDA**

MPV 3.0L	2002-2006
----------	-----------



**RM-194**

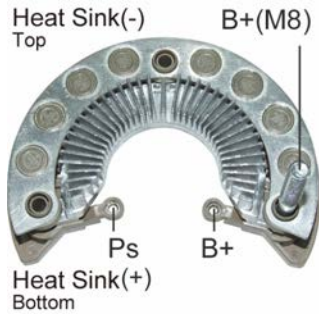

- \*128mm OD
- \*M8 Battery Post
- \*16-35A Avalanche Diodes

Unit no.   
 MITSUBISHI  
 A3TJ0691  
 NISSAN  
 23100-EG010

**Used On**  
**NISSAN**  
 Navara 2.5L 2005-  
 Pathfinder 2.5L 2005-

**RM-199**

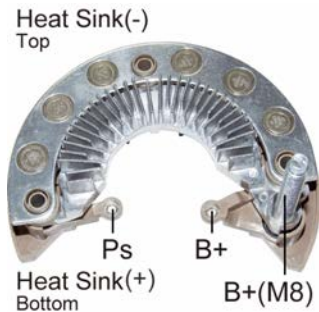

- \*128mm OD
- \*M8 Battery Post
- \*12-50A Avalanche Diodes

Unit no.   
 CHRYSLER  
 4801477AA  
 MITSUBISHI  
 A3TJ2581

**Used On**  
**CHRYSLER**  
 200 2.4L 2011-2012  
 Sebring 2.4L 2007-2010  
**DODGE**  
 Avenger 2.4 2008-2010  
 Caliber 2.4L Turbo 2008-2009  
**JEEP**  
 Compass 2.0L 2007-2010  
 Compass 2.4L 2007-2010  
 Patriot 2.0L 2007-2010  
 Patriot 2.4L 2007-2010

**RM-200**

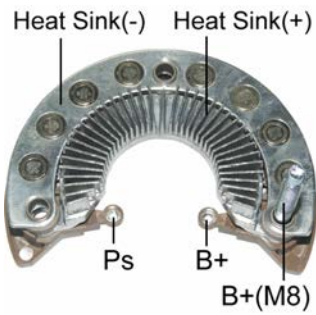

- \*135mm OD
- \*M8 Battery Post
- \*16-50A Avalanche Diodes

Unit no.   
 MITSUBISHI  
 A4TJ0282  
 RENAULT  
 8200654785

**Used On**   
**RENAULT**  
 Laguna 2000 2007-2012

**RM-201**

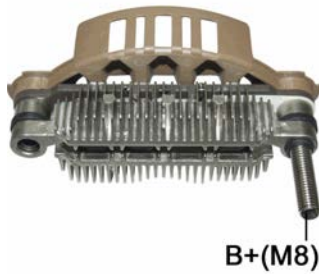

- \*M8 Battery Post
- \*6-50 Amp Diodes

Unit no.   
 MITSUBISHI  
 A3TG1991      A3TG4091

**Used On**   
**PONTIAC**  
 G8 V6 3.6L 2008-2009

**RM-202**

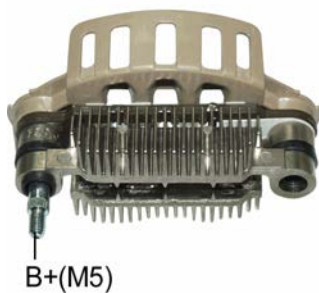

- \*75mm Mtg. Length
- \*M6 Battery Post
- \*6-50 Amp Diodes

Unit no.   
 MITSUBISHI  
 A5TA6292F      A5TA6292G

**RM-203**

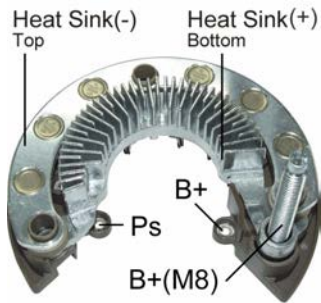

- \*122mm OD
- \*M8 Battery Post
- \*12-50A Avalanche Diodes

Unit no.

CHRYSLER  
 04801490AA      4801490AA  
 MITSUBISHI  
 A2TX0281

Used On

**DODGE**  
 Journey 2.4L      2009-2013

**RM-205**

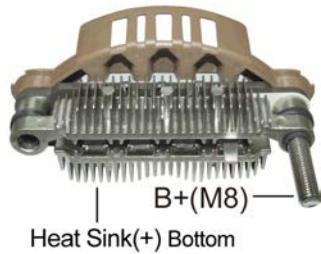

- \*100mm Mtg. Length
- \*M8 Battery Post

Unit no.

MITSUBISHI  
 A3TR0188ZT  
 MITSUBISHI MOTORS  
 ME192608

Used On

**MITSUBISHI**  
 Canter      2007-

**RM-208**

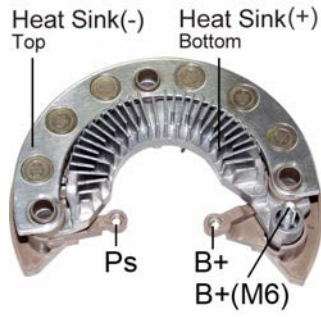

- \*128mm OD
- \*M6 Battery Post
- \*12-50 Amp Diodes

Unit no.

FORD  
 6E5T-10300BA    6E5T-10300BD    6E5Z-10346BA    7E5T-10300BB  
 MITSUBISHI  
 A3TJ0991        A3TJ0991ZC

Used On

**FORD**  
 Fusion V6 3.0L 2006-2009

**RM-209**



- \*75mm Mtg. Length
- \*M6 Battery Post
- \*6-30 Amp diodes

Unit no.

MITSUBISHI  
 A5T06591

Used On

**PROTON**  
 416  
 Wira

**RM-20HV**

- \*75mm Mtg. Length
- \*M6 Battery Post
- \*O.E. Compatible Design with 6-50 Amp Diodes
- \*RM-20 With Block Diodes



**Replaces**

**MITSUBISHI :**  
 A860T22370      A860T22970      A860T25470      A860T32470  
**MITSUBISHI MOTORS :**  
 MD611479

**Unit no.**

MITSUBISHI					
A2T01384	A2T01483	A2T01583	A2T01683	A2T01783	A2T02084
MITSUBISHI MOTORS					
MD103372	MD103373	MD103564	MD106319	MD106320	MD106332

**RM-210HV**

- \*100mm Mtg. Length
- \*M8 Battery Post
- \*8-35 Amp Diodes

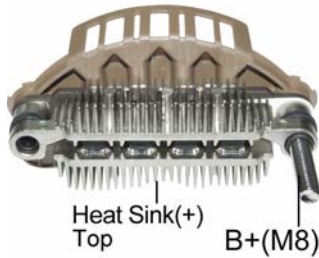

**Unit no.**

MITSUBISHI		
A4TR5188	A4TR5191	A4TR5191ZT
RENAULT		
5001866377	5010480765	
SCANIA		
1516176	1525447	

**RM-212**

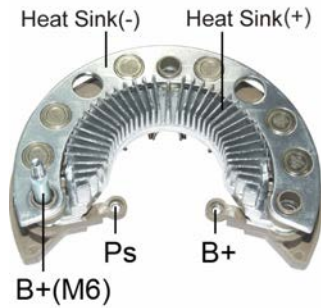

- \*128mm OD
- \*M6 Battery Post
- \*12-35 Amp Diodes

Unit no.   
 MITSUBISHI  
 A3TJ3591  
 SUBARU  
 23700-AA620

**Used On**  
**SUBARU**  
 Legacy 6 Cyl. 3.6L 2010-2011  
 Tribeca 6 Cyl. 3.6L 2010-2011

**RM-213**

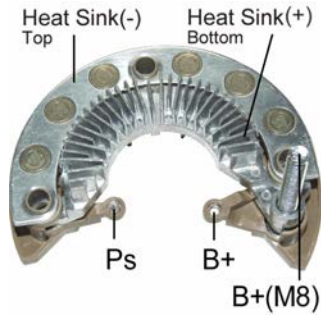

- \*128mm OD
- \*M8 Battery Post
- \*12-50A Avalanche Diodes

Unit no.   
 MITSUBISHI  
 A3TJ2481  
 NISSAN  
 23100-JD71A

**RM-216HD**

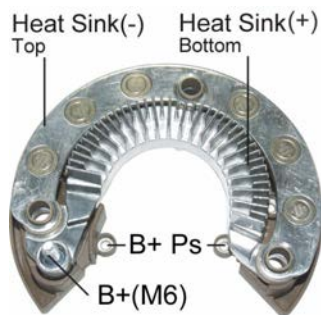

- \*128mm OD
- \*M6 Battery Post
- \*12-70A Avalanche Diodes

Unit no.   
 FORD  
 BL1T-10300BB BL1Z-10346A  
 MITSUBISHI  
 A003TX0692ZC A3TX0692ZC

**RM-22**

- \*75mm Mtg. Length
- \*M6 Battery Post
- \*8-30 Amp Diodes

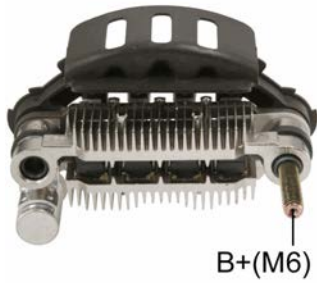

**Replaces**

**MAZDA :**

B3C7-18-W60

**MITSUBISHI :**

A860T39770      A860T37070      A860X45670

**NISSAN :**

23124-OE711      23124-OE712

**Unit no.**

GM

96058486

MITSUBISHI

A1T03195      A5T07091

SUZUKI

31400-60A20

**RM-220HV**

- \*100mm Mtg. Length
- \*6-50A Avalanche Diodes
- \*M5 Battery Post

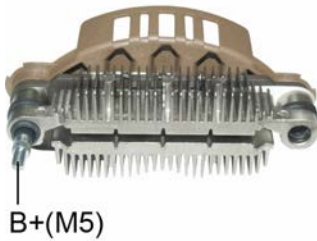

**Unit no.**

MITSUBISHI

A3TG1891

**RM-221**

- \*122mm OD
- \*M6 Battery Post
- \*12-50A Avalanche Diode

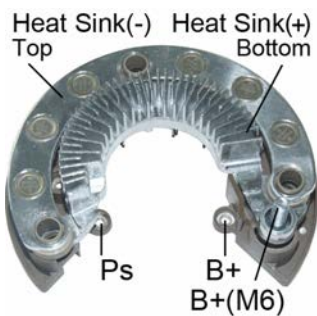

**Unit no.**

MITSUBISHI

A2TX1781      A2TL0091

SUBARU

23700-AA700

**RM-222HV**

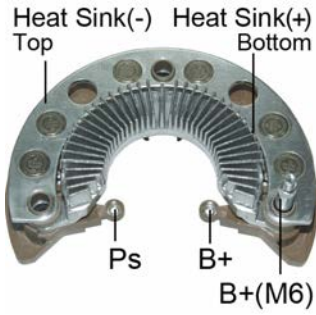

- \*135mm OD
- \*M6 Battery Post
- \*12-50A Avalanche Diodes

**Replaces**

**MITSUBISHI :**  
88375-21274-5531Y

**Unit no.**

MITSUBISHI  
A4TJ0084C

**RM-226HV**

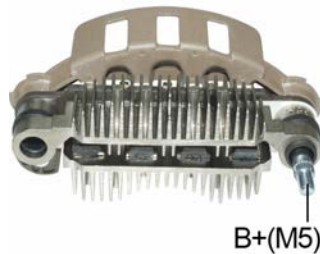

- \*M5 Battery Post
- \*O.E. Compatible Design with 8-50 Amp Diodes

**Unit no.**

MAZDA  
ZJ38-18-300  
MITSUBISHI  
A2TG1391    A002TG1391    A002TG1391ZD    A2TG1391ZD    A11578MI

**RM-23**



- \*75mm Mtg. Length
- \*M5 Battery Post
- \*8-30 Amp Diodes

**Replaces**

**MAZDA :**  
B61P-18-W60    B64J-18-W60  
**MITSUBISHI :**  
A860T32570    A860T37770    A860T37870    A860X45281

**Unit no.**

MAZDA  
BP02-18-300  
MITSUBISHI  
A5T00877    A5T01577    A5T01977    A5T02777    A5T03677    A5T03777



**RM-231HV**

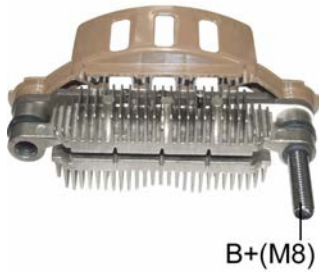

- \*100mm Mtg. Length
- \*M8 Battery Post
- \*O.E. Compatible Design with 8-50 Amp Diodes

**Replaces**

**MITSUBISHI :**  
A860X64570  
**NISSAN :**  
23124-4P116

**Unit no.**

MITSUBISHI  
A3TA7991

**RM-235**

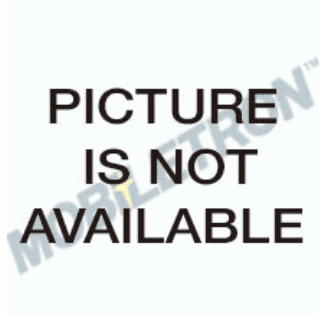

**Unit no.**

MITSUBISHI  
A3TG4679

**RM-236**

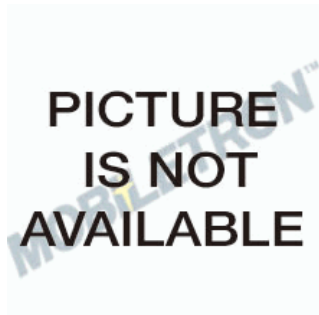

**RM-238**



Unit no.

MITSUBISHI  
 A5TL0191A      A005TL0191A  
 NISSAN  
 23100-1HH1A

Used On

**NISSAN**  
 Micra MK IV Hatchback      2011-2015

**RM-239**

\*12-50A Avalanche Diodes

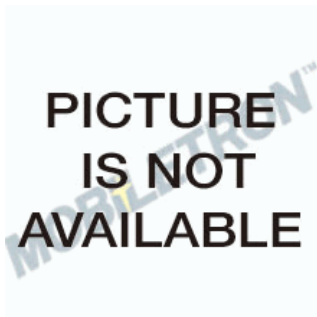

Unit no.

MITSUBISHI  
 A3TX0481

**RM-24**

\*75mm Mtg. Length  
 \*M5 Battery Post  
 \*6-30 Amp Diodes



B+(M5)

Replaces

**MITSUBISHI :**  
 A860X20099

Unit no.

MITSUBISHI  
 A2T07577      A2T34794A      A2T47794  
 NISSAN  
 23100-0H611

**RM-240**

PICTURE  
IS NOT  
AVAILABLE

Unit no. \_\_\_\_\_  
MITSUBISHI  
A7TA3377

**RM-27**

\*75mm Mtg. Length  
\*8-30 Amp Diodes



**Replaces** \_\_\_\_\_  
**MITSUBISHI :**  
A860T38570

Unit no. \_\_\_\_\_  
HONDA  
31100-P00-014  
MITSUBISHI  
A5T04292

**RM-28**

\*75mm Mtg. Length  
\*M5 Battery Post  
\*8-30 Amp Diodes

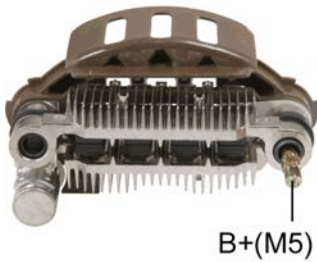

**Replaces** \_\_\_\_\_  
**MITSUBISHI :**  
A866X45281

Unit no. \_\_\_\_\_  
MITSUBISHI  
A5T06391

**RM-29HV**

- \*85mm Mtg. Length
- \*O.E. Compatible Design with 6-50 Amp Diodes
- \*RM-29 With Block Diodes



**Replaces**

**FORD :**  
E8PZ-10301B  
**MITSUBISHI :**  
A860T28670

**Unit no.**

FORD  
E83F-10300AA    E83F-10300AB    E83F-10300BA    E83Z-10346A  
MITSUBISHI  
A3T01596        A3T01598

**RM-30**

- \*85mm Mtg. Length
- \*M6 Battery Post
- \*6-30 Amp Diodes



B+(M6)

**Replaces**

**FORD :**  
E8PZ-10304A    GYE1379  
**MITSUBISHI :**  
A860T28770

**Unit no.**

FORD  
E8SF-10300AA    E8SF-10346A  
MITSUBISHI  
A3T01496

**RM-31**

\*85mm Mtg. Length  
 \*M6 Battery Post  
 \*6-30 Amp Diodes

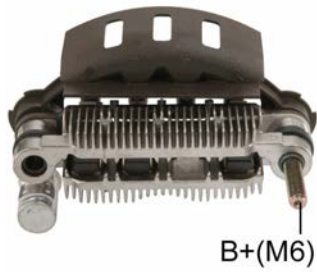

**Replaces**

**MAZDA :**

F825-18-W60      JE15-18-W60

**MITSUBISHI :**

A860T31370      A860T34070

**Unit no.**

**MAZDA**

F285-18-300C      JE15-18-300A

**MITSUBISHI**

A2T13977	A2T19677	A2T19877	A2T19991	A2T20191	A2T32899
A3T00792					

**RM-33**

\*85mm Mtg. Length  
 \*M5 Battery Post  
 \*8-30 Amp Diodes

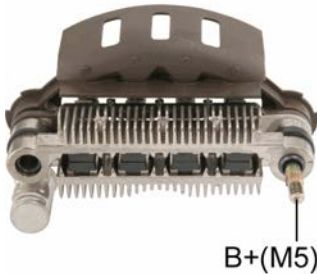

**Unit no.**

**MITSUBISHI**

A3T01691

**SUBARU**

23700-AA060

**RM-34HV**

- \*85mm Mtg. Length
- \*M6 Battery Post
- \*O.E. Compatible Design with 8-50 Amp Diodes
- \*RM-34 With Block Diodes

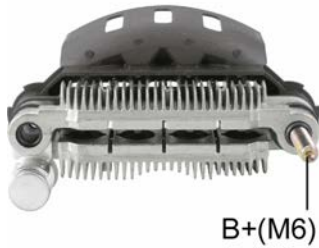

**Replaces**

**MITSUBISHI :**  
A860T23270

**MITSUBISHI MOTORS :**  
MD611586

**Unit no.**

MITSUBISHI  
A3T00692            A3T04292  
MITSUBISHI MOTORS  
MD112323

**RM-36**

- \*85mm Mtg. Length
- \*M6 Battery Post
- \*6-30 Amp Diodes



**Replaces**

**MITSUBISHI :**  
A860T38770

**MITSUBISHI MOTORS :**  
MD618568

**Unit no.**

MITSUBISHI  
A2T34892            A2T34992            A2T35091            A2T35092            A2T36391            A2T36392  
A2T38491            A2T38891            A2T38892            A2T40092  
MITSUBISHI MOTORS  
MD175810            MD175811            MD177244            MD184278            MD184279            MD184280  
MD184281            MD189658            MD189659            MD191402

**RM-37**

- \*85mm Mtg. Length
- \*M8 Battery Post
- \*6-30 Amp Diodes



**Unit no.**

MITSUBISHI  
A2T20091

**RM-38**

- \*85mm Mtg. Length
- \*M5 Battery Post
- \*6-30 Amp Diodes



**Replaces**

**MITSUBISHI :**  
A860T38270

**Unit no.**

MITSUBISHI  
A2T17574      A2T18874      A2T34477

**RM-39**

- \*85mm Mtg. Length
- \*M5 Battery Post
- \*6-30 Amp Diodes
- \*O.E. Compatible

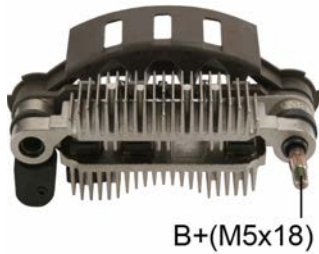

**Replaces**

**MAZDA :**  
B366-18-W60  
**MITSUBISHI :**  
A860T37670      A860T39170

**Unit no.**

MITSUBISHI  
A2T33991      A2T35177

**RM-40**

- \*100mm Mtg. Length
- \*8-30 Amp Diodes

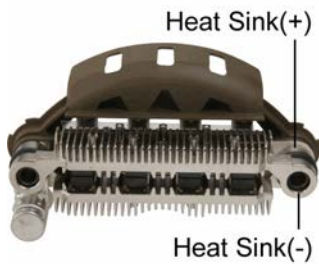

**Replaces**

**MITSUBISHI :**  
A860T23070      A860T28070  
**MITSUBISHI MOTORS :**  
MD611564      MD611768

**Unit no.**

MITSUBISHI  
A3T02192      A3T02193      A3T03391      A3T03392      A3T03393      A3T03493  
A3T04493      A3T08293      A3T41876      A3T41892      A3T45694  
MITSUBISHI MOTORS  
MD111233      MD126110      MD133171      MD136838      MD136839      MD141855  
MD158495      MD168989

**RM-41**

- \*100mm Mtg. Length
- \*M6 Battery Post
- \*8-30 Amp Diodes



B+(M6)

**Replaces**

- FORD :**  
E9PZ-10304B
- MITSUBISHI :**  
A860T35270

**Unit no.**

- FORD
- E9SF-10300DA
- HYUNDAI
- AB175020
- MITSUBISHI
- A4T00796
- MOTORCRAFT
- GLE-265

**RM-42**

- \*100mm Mtg. Length
- \*M5 Battery Post
- \*8-30 Amp Diodes



B+(M5)

**Replaces**

- MITSUBISHI :**  
A860T30170
- SUBARU :**  
23830-AA030

**Unit no.**

- MITSUBISHI
- A3T03891
- SUBARU
- 23700-AA061



**RM-43**

- \*100mm Mtg. Length
- \*M6 Battery Post
- \*8-30 Amp Diodes
- \*w/diode trios



B+(M6)

**Replaces**

**FORD :**

E9PZ10304B

**MITSUBISHI :**

MD611599

MD611742

A860T26070

137486

A600C10301

A860T23070

A860T23370

A860T28070

**VALEO :**

137486

**Unit no.**

**MITSUBISHI**

A4T01493

A4T01893

A4T03191

**MITSUBISHI MOTORS**

MD150657

MD197470

**RM-44**

- \*100mm Mtg. Length
- \*M6 Battery Post
- \*8-30 Amp Diodes



B+(M6)

**Replaces**

**MITSUBISHI :**

A860T31770

A860X31799

A860X34799

**Unit no.**

**MITSUBISHI**

A3T05192

**RM-45**

- \*100mm Mtg. Length
- \*M8 Battery Post
- \*8-30 Amp Diodes



**Replaces**

**MAZDA :**  
JE48-18-W60B  
**MITSUBISHI :**  
A860T36770

**Unit no.**

MAZDA  
JE48-18-300  
MITSUBISHI  
A3T07592

**RM-46**

- \*100mm Mtg. Length
- \*M5 Battery Post
- \*8-30 Amp Diodes

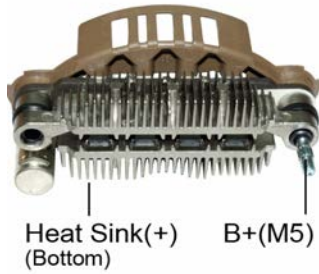

**Replaces**

**MAZDA :**  
K801-18-W60      N3A1-18-W60      135902  
**MITSUBISHI :**  
A860T38670      A860T40270

**Unit no.**

MAZDA  
K801-18-300C  
MITSUBISHI  
A3T08491      A3T08591

**RM-47**

- \*100mm Mtg. Length
- \*M6 Battery Post
- \*8-30 Amp Diodes
- \*O.E. Compatible



B+(M6)

**Replaces**

**MITSUBISHI :**  
A860T42070

**Unit no.**

FORD  
F3LU-10300BC  
MITSUBISHI  
A3T41591

**RM-48**

- \*100mm Mtg. Length
- \*M8 Battery Post
- \*8-30 Amp Diodes



B+(M8)

**Replaces**

**MITSUBISHI :**  
A860T33970

**Unit no.**

FORD  
F3XA-10300AB    F3XA-10300AC  
MITSUBISHI  
A4T02591  
NISSAN  
23100-0B000

**RM-50HV**



B+(M8)

- \*85mm Mtg. Length
- \*M8 Battery Post
- \*O.E. Compatible Design with 6-50 Amp Diodes
- \*RM-50 With Block Diodes

**Replaces**

**MITSUBISHI :**  
 A860T42670      A860T42770  
**MITSUBISHI MOTORS :**  
 MD618734      MD618752

**Unit no.**

MITSUBISHI  
 A2T33891      A2T38391  
 MITSUBISHI MOTORS  
 MD190819      MD198164      MD306649

**RM-53HV**



B+(M6x32)

- \*85mm Mtg. Length
- \*M6 Battery Post
- \*O.E. Compatible Design with 8-50 Amp Diodes
- \*RM-53 With Block Diodes

**Replaces**

**CHRYSLER :**  
 138893  
**MITSUBISHI :**  
 138893

**Unit no.**

CHRYSLER  
 4686106      4609101      4609125      4609320      4661998      4671041  
 4793189;  
 MITSUBISHI  
 A2TA7491      A2T81192      A2T81292      A2T81391

**RM-54HV**



B+(M5)

- \*100mm Mtg. Length
- \*M5 Battery Post
- \*O.E. Compatible Design with 8-50 Amp Diodes
- \*RM-54 With Block Diodes

**Unit no.**

FORD  
 F3LY-10346A

**RM-57**

- \*85mm Mtg. Length
- \*M8 Battery Post
- \*Same as RM-37 except RM-57 is 8-30 Amp Diodes



**Replaces**

**MITSUBISHI :**  
A860T32170

**Unit no.**

MITSUBISHI

A2T34991	A2T35092	A2T38891	A2T38892	A2T39891	A2T40092
A2T83291	A2TA3491				

MITSUBISHI MOTORS

MD175810	MD175811	MD177244	MD184278	MD184279	MD184280
MD184281	MD189658	MD189659	MD191402	MD193323	MD195437
MD309837	MD317401				

**RM-58**

- \*85mm Mtg. Length
- \*M5 Battery Post
- \*Same as RM-39 except RM-58 is 8-30 Amp Diodes



**Replaces**

**MITSUBISHI :**  
A860T38970

**Unit no.**

MITSUBISHI  
A2T33191

**RM-59**



B+(M8)

- \*85mm Mtg. Length
- \*Same as RM-50 except RM-59 is 8-30 Amp Diodes
- \*M8 Battery Post
- \*w/diode trios

**Replaces**

**FORD :**

F32Z-10304A

**MAZDA :**

FS11-18-W60

**MITSUBISHI :**

A860T39070      A860X44170

**MITSUBISHI MOTORS :**

MD618811

**Unit no.**

**FORD**

F32Z-10346A

**MITSUBISHI**

A2T33891	A2T38392	A2T80591	A2T82791	A2T82792	A2T82899
----------	----------	----------	----------	----------	----------

A2TA0991

**MITSUBISHI MOTORS**

MD194482	MD304129	MD306649	MD310997	MD313939	MD314235
----------	----------	----------	----------	----------	----------

MD314236	MD314374	MD315430	MD327535		
----------	----------	----------	----------	--	--

**RM-59HV**



B+(M8)

- \*85mm Mtg. Length
- \*Same as RM-50HV except RM-59HV is 8-50 Amp Diodes
- \*M8 Battery Post
- \*w/diode trios
- \*O.E. Compatible Design

**Replaces**

**FORD :**

F32Z-10304A

**MAZDA :**

FS11-18-W60

**MITSUBISHI :**

A860X42770      A860T39070      A860X44170

**MITSUBISHI MOTORS :**

MD618811

**Unit no.**

**FORD**

F32Z-10346A

**MITSUBISHI**

A2T33891	A2T38392	A2T80591	A2T82791	A2T82792	A2T82899
----------	----------	----------	----------	----------	----------

A2TA0991

**MITSUBISHI MOTORS**

MD194482	MD304129	MD306649	MD310997	MD313939	MD314235
----------	----------	----------	----------	----------	----------

MD314236	MD314374	MD315430	MD327535		
----------	----------	----------	----------	--	--

**RM-60**

\*71mm Mtg. Length  
\*6-35 Amp Diodes



**Replaces**

**LUCAS :**

21511124

**MAZDA :**

D401-24-510

**MITSUBISHI :**

A860T04370      A860T05070      A860T11070

**MITSUBISHI MOTORS :**

MD607429

**NISSAN :**

23124-B9810

**Unit no.**

**MITSUBISHI**

3066857101	3446826100	3446828100	A1T02871	A1T22771	A1T22971
A1T23283	A1T25077	A1T25083	A1T25477	A1T31377	A1T70783
A1T70883	A4T25172	A4T25199			

**NISSAN**

23100-01W10	23100-06T10	23100-B9810	34468-16100		
-------------	-------------	-------------	-------------	--	--

**RM-62**

\*71mm Mtg. Length  
\*6-35 Amp Diodes



**Replaces**

**MAZDA :**

D401-24-510B

**MITSUBISHI :**

134373      A860T11270

**Unit no.**

**MAZDA**

D501-18-300	GE01-18-300				
-------------	-------------	--	--	--	--

**MITSUBISHI**

A1T23277	A1T23377	A1T31371	A1T31374	A1T31377	A3T03291
A3T03292	A3T03298	A3T45191			

**RM-63**

\*71mm Mtg. Length  
\*6-35 Amp Diodes



**Replaces**

**MAZDA :**

D501-24-510      GE01-24-510

**MITSUBISHI :**

A860T07170

**Unit no.**

**MAZDA**

D401-18-300      H612-18-300

**MITSUBISHI**

A1T23377      A1T31374      A1T31377      A1T3377

**RM-64**

\*71mm Mtg. Length  
\*6-35 Amp Diodes

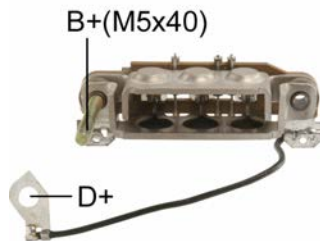

**Replaces**

**MAZDA :**

S201-24-510      S501-24-510

**MITSUBISHI :**

A860T06570

**Unit no.**

**MAZDA**

S201-18-300A      S241-18-300      S2T3-18-300      S501-18-300      S509-18-300

**MITSUBISHI**

A001T31371      A001T31374      A1T31179      A1T31579



**RM-65**

\*80mm Mtg. Length  
\*6-35 Amp Diodes

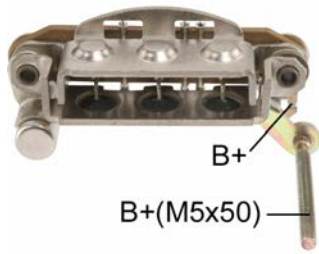

**Replaces**

**LUCAS :**

21513130            UBJ256

**MAGNETI MARELLI :**

940038257

**mitsubishi :**

A860T08270

**mitsubishi MOTORS :**

MD607616

**Unit no.**

**mitsubishi**

A5T15584	A5T15684	A5T15784	A5T15884	A5T20484	A5T21684
----------	----------	----------	----------	----------	----------

A5T22484

**mitsubishi MOTORS**

MD013740	MD061818	MD068565	MD069859	MD072582	MD086016
----------	----------	----------	----------	----------	----------

**RM-66**

\*80mm Mtg. Length  
\*6-35 Amp Diodes



**Replaces**

**LUCAS :**

21513107            UBJ257

**MAZDA :**

N221-24-510

**mitsubishi :**

A860T06070	A860T06082	A860T06470
------------	------------	------------

**mitsubishi MOTORS :**

MD607568

**Unit no.**

**MAZDA**

HE45-18-300	N221-18-300
-------------	-------------

**mitsubishi**

A5T10271	A5T15171	A5T15177	A5T15371	A5T15471	A5T20374
----------	----------	----------	----------	----------	----------

A5T20377	A5T20571	A5T20577	A5T21071	A5T21077	A5T21171
----------	----------	----------	----------	----------	----------

A5T23277	HE4518300A
----------	------------

**mitsubishi MOTORS**

MD015040	MD015041	MD034130	MD034132	MD063781	MD064066
----------	----------	----------	----------	----------	----------

MD064067	MD064068	MD104744
----------	----------	----------

**RM-67**

\*80mm Mtg. Length  
\*6-35 Amp Diodes

B+(M5x40)



**Replaces**

**LUCAS :**

21513134

**MAZDA :**

E356-24-510      E563-24-510

**MITSUBISHI :**

A860T10770

**Unit no.**

**MAZDA**

E331-18-300A      E563-18-300A      E5A1-18-300A

**MITSUBISHI**

A5T21471      A5T21472      A5T30171

**RM-68**

\*85mm Mtg. Length  
\*6-35 Amp Diodes



**Replaces**

**LUCAS :**

21513100      UBJ219

**MAGNETI MARELLI :**

940038247

**MAZDA :**

8173-24-510

**MITSUBISHI :**

A860T03970      A860T05170

**MITSUBISHI MOTORS :**

MD607370      MD607441

**Unit no.**

**MAZDA**

8341-18-300      8492-18-300      E303-18-300

**MITSUBISHI**

A2T12371      A2T12671      A2T16371      A2T16471      A2T16477      A2T16871

A2T17172      A2T20972      A2T23071      A2T23271      A2T23471      A2T23474

A2T23477      A2T23494      A2T24172      A2T24272      A2T24371      A2T24372

A2T24377      A2T24671      A2T24771      A2T24971      A2T24972      A2T25772

AQ2240K1      AQ2245G      AQ2245G1      AQ2245K1      AQ2250      AQ2250G1

AQ2250G7      AQ2250K1

**MITSUBISHI MOTORS**

MD006187      MD006197      MD007509      MD009052      MD009053      MD009054

MD022572      MD022578      MD022579      MD027660      MD027661      MD041700

**NISSAN**

23100-D0111      23100-H7711      23100-H9011      23100-N9511      23100-P2518      23100-Q4511

23100-Q7111      23100-W1502      23100W28100      23100-W7015

**RM-69**

\*85mm Mtg. Length  
\*6-35 Amp Diodes



**Replaces**

**MAZDA :**  
8173-24-510A  
**MITSUBISHI :**  
A860T07270

**Unit no.**

MAZDA					
1480-18-300	8173-18-300B	E302-18-300			
MITSUBISHI					
A2T23471	A2T23474	A2T23477	A2T23494	A2T25071	A2T26072

**RM-70**

\*85mm Mtg. Length  
\*Same as RM-83 Except with P Terminal.  
\*6-35 Amp Diodes



**Replaces**

**MAZDA :**  
FE01-24-510A HE412-45-10  
**MITSUBISHI :**  
A860T08370 A860T10470

**Unit no.**

MAZDA					
F601-18-300A	F807-18-300A	FE01-15-300B	FE01-18-300B	H834-18-300	HE19-18-300A
HE41-18-300					
MITSUBISHI					
A2T31677	A2T31977	A2T40374	A2T40377	A2T40571	A2T40577
A2T40671	A2T40773	A2T41091	A2T41191	A2T41371	A2T41377

**RM-71**

\*85mm Mtg. Length  
\*6-35 Amp Diodes

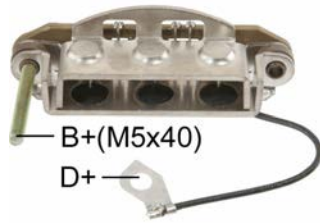

**Replaces**

**MAZDA :**

8599-24-510

**MITSUBISHI :**

A860T06370

**Unit no.**

MITSUBISHI

859918300	A2T25479	A2T25679	S50218300C
-----------	----------	----------	------------

**RM-72**

\*85mm Mtg. Length  
\*Same as RM-69 Except with P Terminal.  
\*6-35 Amp Diodes



**Replaces**

**LUCAS :**

21513101      UBJ292

**MITSUBISHI :**

A860T07270

**Unit no.**

MAZDA

1480-18-300	3841-18-300	8173-18-300B	8302-18-300
-------------	-------------	--------------	-------------

MITSUBISHI

A2T23471	A2T23474	A2T23477	A2T23494	A2T25071	A2T26072
----------	----------	----------	----------	----------	----------

**RM-73**

\*85mm Mtg. Length  
\*6-35 Amp Diodes

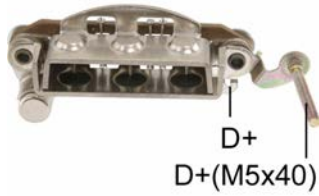

**Replaces**

**LUCAS :**

21513105            UBJ302

**MAZDA :**

S215-24-510

**MITSUBISHI :**

A860T08770        A860T15170

**MITSUBISHI MOTORS :**

MD607680        ME700636        ME700836

**NISSAN :**

23230-04D00

**Unit no.**

**MAZDA**

RF03-18-300C

**MITSUBISHI**

A002T72576        A2T27176        A2T27376        A2T40483        A2T40484        A2T41477

A2T41483        A2T41599        A2T41899        A2T43183        A2T43583        A2T72186

A2T72188        A2T72189        A2T72190        A2T72286        A2T72299        A2T72378

A2T72383        A2T72576        A2T72676        A2T72776        A2T72893        A2T73176

A2T73499        A2T73586        A2T74599        A2T75686

**MITSUBISHI MOTORS**

MD050190        MD061430        MD087246        MD607680        ME007582        ME017562

ME017585        ME017602        ME037616        ME037640        ME057658        ME067522

ME067622        ME087501        ME087595        ME087642        ME700836        S51618300

SE4718300        SL2118300A        SL2418300        SL5618300A

**NISSAN**

23100-04D00        23100-04D01

**RM-74**

\*100mm Mtg. Length  
 \*6-35 Amp Diodes



**Replaces**

**LUCAS :**

21513128

**MAZDA :**

4130-24-510B      FE05-24-510

**MITSUBISHI :**

A860T10370      A860T11370

**MITSUBISHI MOTORS :**

MD607818

**Unit no.**

**MAZDA**

8356-18-300	8574-18-300	FE05-18-300B	HE21-18-300A	HE26-18-300B	N236-18-300
-------------	-------------	--------------	--------------	--------------	-------------

**MITSUBISHI**

A3T21278	A3T21677	A3T34077	A3T34391	A3T34572	A3T34672
----------	----------	----------	----------	----------	----------

A3T34677	A3T35091				
----------	----------	--	--	--	--

**MITSUBISHI MOTORS**

MD086046	MD086047	MD086048			
----------	----------	----------	--	--	--

**NISSAN**

23100-05P11

**RM-75**

\*100mm Mtg. Length  
\*6-35 Amp Diodes



**Replaces**

**LUCAS :**

21513102            UBJ208

**MAGNETI MARELLI :**

940038246

**MAZDA :**

4130-24-510A      4130-24-560      E301-24-510A

**mitsubishi :**

A860T04170      A860T05270      A860T07370      A860T07770

**mitsubishi MOTORS :**

MD607385      MD607529

**NISSAN :**

23124-Q4610

**Unit no.**

**MAZDA**

4119-18-300      4130-18-300      4199-18-300      E301-18-300C      E301-18-300D

**mitsubishi**

A2T25171      A2T26172      A3T21277      A3T21278      A3T21371      A3T21471

A3T21677      A3T32172      A3T32271      A3T32272      A3T32377      A3T32674

A3T32771      A3T32772      A3T32872      A3T32877      A3T33272      A3T33377

A3T33772      A3T33977      AQ2355G1

**mitsubishi MOTORS**

MD018230      MD022576      MD025677      MD025679      MD041705      MD041706

**NISSAN**

23100-D0211      23100-P3016      23100-Q0811      23100-Q4611      23100-W1615      23100-W5816

23100-W7510      24468-28100

**RM-76**

\*100mm Mtg. Length  
\*6-35 Amp Diodes



B+(M5x53)

**Replaces**

**LUCAS :**

21511121            UBJ220

**MAGNETI MARELLI :**

940038256

**mitsubishi :**

A860T11770

**NISSAN :**

23124-05E16

**Unit no.**

**mitsubishi**

A003T35278      A003T35299A      A3T35278

**NISSAN**

23100-05E17      23100-05E18      23100-05E70

**RM-78**

\*71mm Mtg. Length  
\*6-35 Amp Diodes

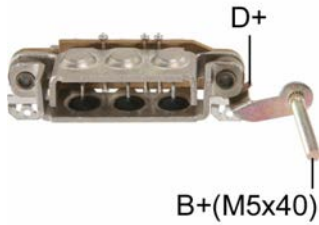

**Replaces**

**MAZDA :**  
S205-24-510  
**MITSUBISHI :**  
A860T08570

**Unit no.**

MAZDA					
S515-18-300	SE45-18-300	SL01-18-300	SL07-18-300	SL44-18-300A	SL50-18-300C
MITSUBISHI					
A1T33576	A1T33676	A1T71076	A1T71176	A1T71276	A1T71576
MITSUBISHI MOTORS					
S51518300	SE4518300	SL0118300	SL0718300	SL4418300A	SL5018300C

**RM-80**

\*100mm Mtg. Length  
\*M5 Battery Post  
\*6-30 Amp Diodes  
\*O.E. Compatible

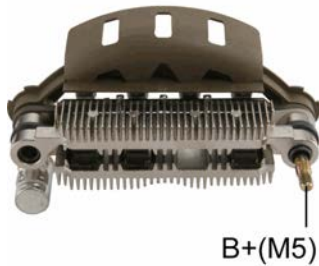

**Replaces**

**MITSUBISHI :**  
A860T26470

**Unit no.**

MITSUBISHI	
A3T01877	A3T01877A

**RM-81**

\*64mm Mtg. Length  
\*6-30 Amp Diodes  
\*O.E. Compatible



**Replaces**

**MITSUBISHI :**  
A860T18870      A860T18899  
**NISSAN :**  
23124-17B10

**Unit no.**

MITSUBISHI			
A5T01892	A5T22971B	A5T22997	A5T22997B



**RM-82**

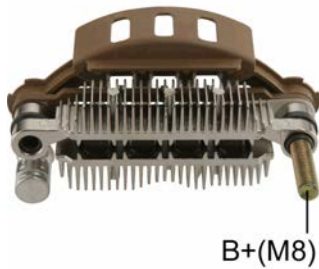

- \*100mm Mtg. Length
- \*M8 Battery Post
- \*8-30 Amp Diodes
- \*O.E. Compatible

Unit no.

MITSUBISHI

A4T02891

A4T02891A

A4T02891B

A4T02892

A4T02892A

A4T03292

A4T03292A

**RM-83**



- \*85mm Mtg. Length
- \*6-35 Amp Diodes

Replaces

**MAZDA :**

FE01-24-510A HE41-24-510

**MITSUBISHI :**

A860T08370 A860T10470

**MITSUBISHI MOTORS :**

MD607693

Unit no.

MAZDA

F601-18-300A

F807-18-300A

FE01-18-300B

H834-18-300

HE19-18-300A

HE41-18-300

MITSUBISHI

A2T31677

A2T31977

A2T40374

A2T40377

A2T40571

A2T40577

A2T40671

A2T41191

A2T41371

A2T41377

A2T41991

MITSUBISHI MOTORS

MD015020

MD015021

MD019179

MD025679

MD074645

**RM-84**

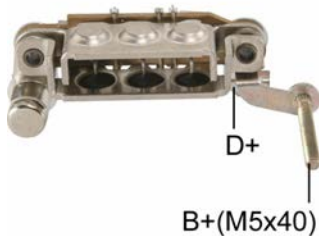

- \*71mm Mtg. Length
- \*M5 Battery Post
- \*6-35 Amp Diodes
- \*For use on:
- \*MAZDA Titan E2500,E3000 series.

Replaces

**MITSUBISHI :**

A860T12870

**RM-85**

\*80mm Mtg. Length  
\*6-35 Amp Diodes



**Replaces**

**LUCAS :**

21511122

**MITSUBISHI :**

A860T08470

**NISSAN :**

23124-W5811

**Unit no.**

MITSUBISHI

A5T00272

A5T20871

A5T20872

A5T21871

A5T21897

NISSAN

23100-05B10

23100-10B10

23100-27G10

23100-M6610

23100-N9512

**RM-86**

\*80mm Mtg. Length  
\*M5 Battery Post  
\*6-35 Amp Diodes

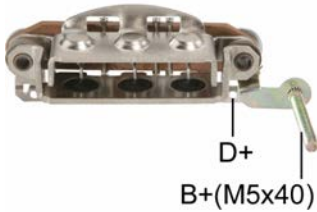

**Replaces**

**MITSUBISHI :**

A860T14570

**MITSUBISHI MOTORS :**

ME700555

**Unit no.**

MITSUBISHI

A5T22578

A5T22583

A5T70178

A5T70183

A5T70283

MITSUBISHI MOTORS

ME001570

ME007577

ME007578

ME017560

ME017561

**RM-87**

\*100mm Mtg. Length  
\*M8 Battery Post  
\*6-30 Amp Diodes  
\*O.E. Compatible

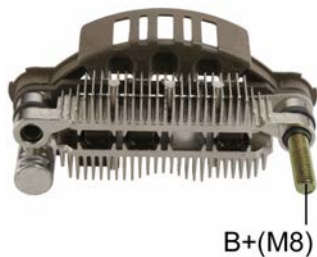

**Unit no.**

MITSUBISHI

A3TA0591

A3TA0591C

A3TA0591D

A3TA0591E

A3TA0591F

A3TA0593C

A3TA0791

**RM-89**

- \*100mm Mtg. Length
- \*M8 Battery Post
- \*8-30 Amp Diodes
- \*O.E. Compatible



B+(M8x30)

Unit no.

MITSUBISHI

A4T00891

A4T00991

A4T03392

A4T03492

**RM-90**

- \*85mm Mtg. Length
- \*M6 Battery Post
- \*6-30 Amp Diodes
- \*O.E. Compatible



B+(M6x32)

D+(M5x20)

Unit no.

MITSUBISHI

A2T81891

A2TA2591

**RM-94**

- \*85mm Mtg. Length
- \*M5 Battery Post
- \*6-30 Amp Diodes
- \*O.E. Compatible



B+(M5)

**Replaces**

MITSUBISHI :

A860T06870

Unit no.

MITSUBISHI

A2TA1991

A2TA1991D

A2TA1994

A2TA1994B

A2TA1994C

A2TA1994D

A2TA2091D

A2TA2091E

A2TA2091F

A2TA2094

A2TA2094B

A2TA2094C

A2TA2094D

**RM-95HV**

B+(M5)



- \*75mm Mtg. Length
- \*M5 Battery Post
- \*O.E. Compatible Design with 8-50 Amp Diodes
- \*RM-95 With Block Diodes

**Replaces**

**MITSUBISHI :**  
A860T18570

**Unit no.**

MITSUBISHI  
A2T46591

**RM-96**

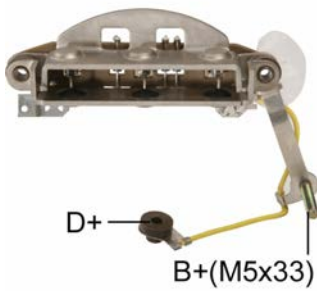

- \*100mm Mtg. Length
- \*M5 Battery Post
- \*6-35 Amp Diodes

**Replaces**

**MITSUBISHI :**  
A860T06270  
**NISSAN :**  
23124-W1715

**Unit no.**

MITSUBISHI  
A3T33678      A3T33684      A3T33698

**RM-97HV**



- \*85mm Mtg. Length
- \*M5 Battery Post
- \*OE Compatible Design with 6-50 Amp Diodes
- \*RM-97 With Block Diodes

**Replaces**

**MITSUBISHI :**  
A860T41670

**Unit no.**

MITSUBISHI  
A2T36478

**RM-98**



B+(M5)

- \*85mm Mtg. Length
- \*M5 Battery Post
- \*8-30 Amp Diodes
- \*Same as RM-38 except RM-98 is with 8 diodes

**Replaces**

**MITSUBISHI :**  
A860T33470      A860T38270

**Unit no.**

MITSUBISHI  
A2T17574      A2T18874      A2T34477

**RM-99HV**

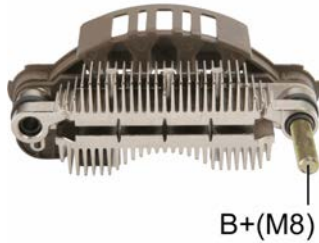

B+(M8)

- \*100mm Mtg. Length
- \*M8 Battery Post
- \*O.E. Compatible Design with 8-50 Amp Diodes
- \*RM-99 With Block Diodes

**Unit no.**

MITSUBISHI  
A3TN1791



**RP-44A**

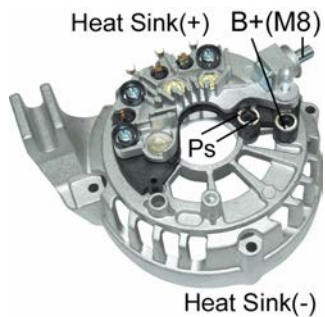

- \*103mm OD
- \*6-50A Avalanche Diodes
- \*Negative & Positive Assembly

Unit no.

DELCO

10317647 10440635

VALEO

2542558 2650010 2650016 SG10S029 SG10S035 SG10S037  
SG12S029 SG12S035

**RP-52**

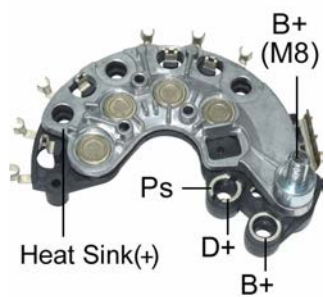

- \*103mm OD
- \*M8 Battery Post
- \*4-50A Avalanche Diodes
- \*Positive rectifier

Replaces

VALEO :  
5498776

Unit no.

VALEO  
SG10S012

**RP-57**

\*103mm OD  
 \*M8 Battery Post  
 \*3-50A Avalanche Diodes

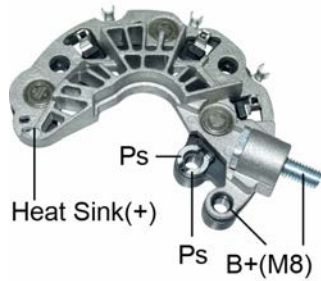

**Replaces**

VALEO :  
 2603196

**Unit no.**

FORD

7G9N-10300CA	AV6N-10300HA	7G9N-10300CA	1698214	1469714	1685794
7G9N-10300CC	7G9N-10300CC				

VALEO

TG12C037	TG12C087	2606952B			
----------	----------	----------	--	--	--

**Used On**

FORD

Fiesta 1.4	2008-
Fiesta 1.6 Ti	2008-
Mondeo 1.6	2007-
Mondeo IV Turnier 1.6	2007-

**RP-59**

\*114mm OD  
 \*M8 Battery Post  
 \*6-50A Avalanche Diodes

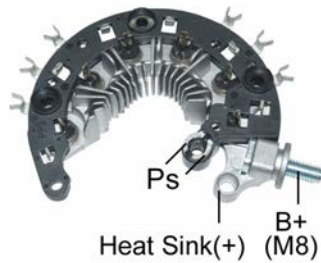

**Unit no.**

BMW

12317521178	12317525376
-------------	-------------

**Used On**

BMW

325i	N52B30A	2005-2007
330	N52B30O0	2005-
520i	N46B20B	2007-2010
523i	N52B25A	2007-
525i	N52B25O0	2005-2010
530i	N52B30O0	2007-
525i Touring	N52B25O0	2005-2007
630i	N52B30O0	2004-2007
730i	N52B30O0	2005-2007
530i Touring	N52B30A	2007-
325i Coupe	N52B25O0	2006-
325i Convertible	N52B25A	2007-
318 d	M47D20U2	2005-2007





**RP-69HD**

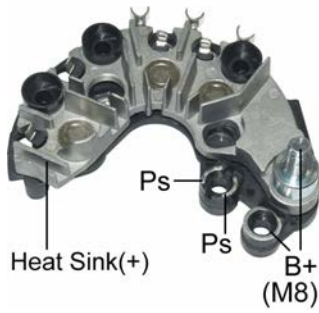

- \*110mm OD
- \*M8 Battery Post
- \*3-70A Avalanche Diodes
- \*Positive Rectifier

Unit no.

VALEO  
SG14B023

**RP-80**

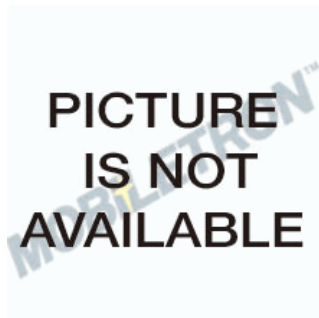

Unit no.

VALEO  
TG9S036

**RU-01**

\*6-25 Amp Diodes



**Replaces**

**VALEO :**

NC013                      NC014

**VALEO(DUCELLIER) :**

581025	581071	581078	593074	606625	611197
611199	611788	618093	618439	618503	618720
690260	690971				

**Unit no.**

**VALEO(DUCELLIER)**

513001A	513001B	513001C	513003A	513003B	513003C
513008A	513008B	513008C	513008D	514006A	514006B
514011A	514011B	514011C	514011D	514012A	514012B
514012C	514012D	514013A	515001A	515002A	515002B
515002C	515003A	515003B	515003C	515009A	515014A
515015A	515016A	515018A	516006A	516006B	516006C
516006D	516006E	516017A	516017B	516020A	516020B
516020C	516020D	516023A	516023B	516023C	516023D
516024A	516024B	516024C	516024D	516025A	516025B
516025C	516026A	516026B	516033A	516033B	516033C
516035A	516035B	516035C	516037A	516037B	516037C
516038A	516038B	516038C	516044A	516044B	516044C
516047A	516048A	516048B	516057A	516057B	516058A
516062A	581207A	581207B	581207C	581207D	581208A
581208B	593009A	593009B	593009C	750A	750B
750C	750D	750E	750F	750G	7527B
7527C	7548A	7549A	7549B	7549C	7549D
7549E	7549F	7549G	7558A	7558B	7558C
7575A	7575B	7575C	7575D	7575E	7576A
7577A	7577B	7577C	7577D	7577E	7577F
7577G	7577H	7578A	7578B	7578C	7578D
7581A	7581B	7581C	7582A	7584C	7584D
7585A	7585B	7585C	7585D	7586A	7586B
7586C	7586D	7586E	7591A	7591B	7591C
7591D	7591E	7596A	7596B	7596C	7596D
7596E	7596F	7597A	7597B	7597C	7597D
7597E	7597F				

**RU-01H**

\*RU-01H(35A)  
\*35 Amp Diodes

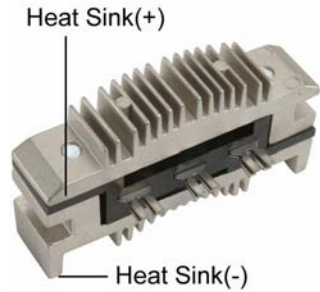

**Replaces**

**VALEO :**

NC013                      NC014

**VALEO(DUCELLIER) :**

581025	581071	581078	593074	606625	611197
611199	611788	618093	618439	618503	618720
690260	690971				

**Unit no.**

VALEO(DUCELLIER)

513001A	513001B	513001C	513003A	513003B	513003C
513008A	513008B	513008C	513008D	514006A	514006B
514011A	514011B	514011C	514011D	514012A	514012B
514012C	514012D	514013A	515001A	515002A	515002B
515002C	515003A	515003B	515003C	515009A	515014A
515015A	515016A	515018A	516006A	516006B	516006C
516006D	516006E	516017A	516017B	516020A	516020B
516020C	516020D	516023A	516023B	516023C	516023D
516024A	516024B	516024C	516024D	516025A	516025B
516025C	516026A	516026B	516033A	516033B	516033C
516035A	516035B	516035C	516037A	516037B	516037C
516038A	516038B	516038C	516044A	516044B	516044C
516047A	516048A	516048B	516057A	516057B	516058A
516062A	581207A	581207B	581207C	581207D	581208A
581208B	593009A	593009B	593009C	750A	750B
750C	750D	750E	750F	750G	7527B
7527C	7548A	7549A	7549B	7549C	7549D
7549E	7549F	7549G	7558A	7558B	7558C
7575A	7575B	7575C	7575D	7575E	7576A
7577A	7577B	7577C	7577D	7577E	7577F
7577G	7577H	7578A	7578B	7578C	7578D
7581A	7581B	7581C	7582A	7584C	7584D
7585A	7585B	7585C	7585D	7586A	7586B
7586C	7586D	7586E	7591A	7591B	7591C
7591D	7591E	7596A	7596B	7596C	7596D
7596E	7596F	7597A	7597B	7597C	7597D
7597E	7597F				

**RU-02H**

\*6-35 Amp Diodes

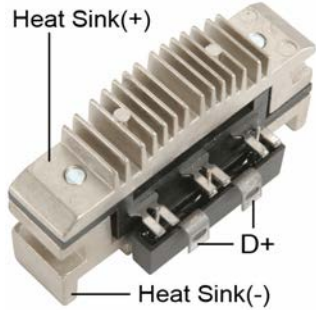

**Replaces**

**DELCO REMY (LUCAS) :**

21220366

**VALEO :**

NB928                      NB931

**VALEO(DUCELLIER) :**

581004	581015	581020	581064	581090	593075
611544	612318	618043	618487	618568	690744
691337					

**Unit no.**

VALEO(DUCELLIER)

506053A	513002A	513002B	513002C	513004A	513004B
513004C	513005A	513005B	513009D	513010A	513010B
513010C	513010D	513011A	513014A	514002A	514002B
514004A	514005A	514005B	514005C	514005D	514005E
514005F	514007A	514007C	514007D	514007E	514007F
514010A	514010B	514010C	514010D	514014A	515006A
515008A	515008B	515010A	515013A	515014B	516002A
516002B	516002C	516002D	516003A	516003B	516003C
516004A	516004B	516005A	516012A	516012B	516012C
516014A	516019A	516019B	516021A	516027B	516032A
516032B	516040A	516040B	516040C	516041A	516041B
516041C	516046A	516054A	516055A	516055B	7564A
7564B	7569D	7571A	7571B	7571C	7590A
7590B	7590C	7590D	7590E	7595A	7595B
7599A	7599B				

**RU-03**

\*6-25 Amp Diodes



**Replaces**

**VALEO :**

NC015

**VALEO(DUCELLIER) :**

581162                      690973

**Unit no.**

VALEO(DUCELLIER)

516013A	516013B	516013C	516015A	516016A	516016B
516050A	7584E				

**RU-05H**

\*6-35 Amp Diodes



**Replaces**

VALEO :  
NC017

VALEO(DUCELLIER) :  
581163            690974            691463

**Unit no.**

VALEO(DUCELLIER)  
516007A            516007B            516007C            516007D            516029A            516029B

**RT-01H**

\*6-35 Amp Diodes

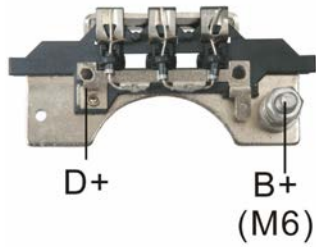

**Replaces**

**LUCAS :**

21229200                    UBB509

**MAGNETI MARELLI :**

940038290

**VALEO :**

2522179                    501049                    A418320A                    NB444

**VALEO(DUCELLIER) :**

593068

**VALEO(MOTOROLA) :**

501-037                    501-038                    501-046                    501-065                    501-46

**Unit no.**

VALEO(MOTOROLA)

9AL2969F	9AR2682F	9AR2716G	9AR2717G	9AR2718G	9AR2719G
9AR2749G	9AR2750G	9AR2751G	9AR2799G	9AR2814D	9AR2821G
9AR2882F	9AR2887G				

**RT-02H**

\*6-35 Amp Diodes

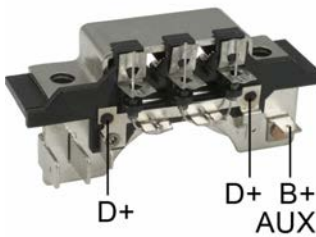

**Replaces**

**MAGNETI MARELLI :**

940038287

**VALEO :**

2522172                    2522173                    NB427                    NB751

**VALEO(DUCELLIER) :**

593070

**VALEO(MOTOROLA) :**

501-024                    501-063

**Unit no.**

VALEO(MOTOROLA)

9AR2526F	9AR2527K	9AR2528F	9AR2605L	9AR2610G	9AR2622L
9AR2627G	9AR2636G	9AR2650D	9AR2651D	9AR2652F	9AR2653F
9AR2654G	9AR2655G	9AR2683G	9AR5098F1		

**RT-03H**

\*6-35 Amp Diodes

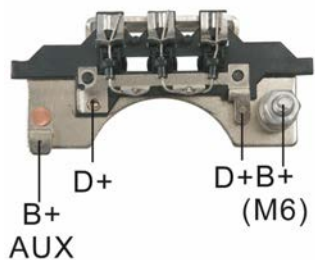

**Replaces**

**LUCAS :**

21229204                    UBB508

**MAGNETI MARELLI :**

940038289

**VALEO :**

2522178                    NB095

**VALEO(MOTOROLA) :**

501-027

**Unit no.**

VALEO(MOTOROLA)

9AR2662F

9AR2664F

9AR2748G

9AR2828G

9AR2829G

9AR2871F

9AR2875G

**RT-04H**

\*6-35 Amp Diodes

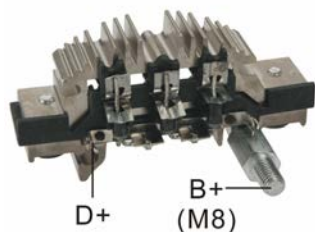

**Replaces**

**VALEO :**

2522200

**VALEO(MOTOROLA) :**

501-104

**Unit no.**

VALEO(MOTOROLA)

9AR3802L

9AR3835L

9AR6035L

9AR6057L

9AR6058L



**RT-05H**

\*6-35 Amp Diodes

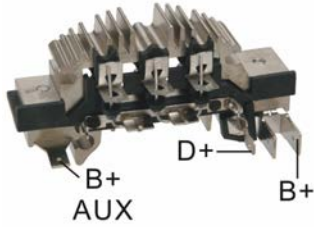

**Replaces**

**LUCAS :**

21229192                    21229218                    UBB506                    UBB513

**MAGNETI MARELLI :**

940038282

**VALEO :**

2522148                    2522165                    592555                    NB128                    NB142                    NC481

**VALEO(DUCELLIER) :**

593073

**VALEO(MOTOROLA) :**

501-004                    501-006                    501-007                    501-030                    501-044                    501-058  
501-092                    501-105                    501-124

**Unit no.**

VALEO(MOTOROLA)

9AL2615G	9AL2688K	9AL2689K	9AR11711	9AR2512P	9AR2530K
9AR2533P	9AR2539K	9AR2545K	9AR2561K	9AR2562K	9AR2569G
9AR2570G	9AR2594G	9AR2602F	9AR2603F	9AR2604L	9AR2611F
9AR2612G	9AR2613F	9AR2614G	9AR2630K	9AR2637P	9AR2684P
9AR2725F	9AR27459K02	9AR2759K	9AR2759K0	9AR2759K01	9AR2759K02
9AR2784K	9AR2785K	9AR2786K	9AR2833K	9AR2846K	9AR2851K
9AR2852K	9AR2853K	9AR2861K	9AR2862K	9AR2929G	9AR2944K
9AR29631	9AR2963L	9AR2970K	9AR2971G	9AR2972G	9AR2973L
9AR2974L	9AR2975L	9AR2976K	9AR2977L	9AR2981L	9AR2982L
9AR3802L	9AR3825L	9AR5010F	9AR5010K	9AR5028K	9AR5028K0
9AR5028K01	9AR5028K02	9AR5040K	9AR5044K	9AR5046G	9AR5070K
9AR5081K	9AR5082G	9AR5083G	9AR5084L	9AR5085L	9AR5086L
9AR5087K	9AR5088L	9AR5089G	9AR5090L	9AR5092K	9AR5092K0
9AR5092K01	9AR5092K02	9AR5099L	9AR5100G	9AR5101K	9AR5107L
9AR5108K	9AR6053L	9AR6057L	9AR6058L		

**RT-06H**

\*6-35 Amp Diodes  
 \*Economy Version: RT-06HA

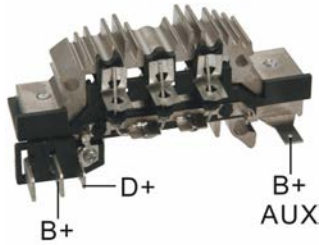

**Replaces**

**BOSCH :**

30509

**DENSO :**

0260002432	0260002540	0260002680	0260002720	0260003190	0260003230
0260003330	0260003350	0260003510	0260003560	0260003570	0260003700
0260003860	0260003861	0260003880	0260003980		

**ISKRA :**

16905321

**ISUZU :**

1-81270001-0

**LUCAS :**

21229191            UBB505

**MAGNETI MARELLI :**

940038283

**NIKKO :**

7-44000-0900

**VALEO :**

NB739	NB744	NB763	NB428	NB435	2522190
-------	-------	-------	-------	-------	---------

**VALEO(DUCELLIER) :**

593069            592837

**VALEO(MOTOROLA) :**

501-093	501-001	501-009	501-053	501-076	501-111
---------	---------	---------	---------	---------	---------

**Unit no.**

**VALEO(MOTOROLA)**

2941388	9AR2500K	9AR2506K	9AR2511F	9AR2515K	9AR2516F
9AR2517K	9AR2518F	9AR2519F	9AR2520K	9AR2524F	9AR2525K
9AR2709L	9AR2756F	9AR2884L	9AR2897L	9AR2919P	9AR2920P
9AR2997K	9AR5036L				

**RT-07H**

\*6-35 Amp Diodes



**Replaces**

**LUCAS :**

21229193            UBB503

**MAGNETI MARELLI :**

940038281        940038292

**VALEO :**

NB117	NB120	NB122	NB123	NB136	NB436
NB439					

**VALEO(MOTOROLA) :**

501-003	501-008	501-012	501-015	501-019	501-025
501-032	501-039	501-041	501-043	501-047	501-048
501-056	501-062	501-067	501-068	501-071	501-073
501-096	501-098	501-100	501-101	501-102	501-107
501-108	501-112	501-114	501-115	501-118	

**Unit no.**

**VALEO(MOTOROLA)**

9AR2501K	9AR2566K	9AR2596K	9AR2714F	9AR2810L	9AR2930G
9AR3599G	9AR5037L	9AR6095G			

**RT-08H**

\*6-35 Amp Diodes



**Replaces**

**LUCAS :**

21229194            UBB507

**MAGNETI MARELLI :**

940038284

**VALEO :**

2522197	2522208	501077	NB126	NB138	
---------	---------	--------	-------	-------	--

**VALEO(MOTOROLA) :**

501-002	501-010	501-011	501-017	501-018	501-052
501-057	501-059	501-069	501-103	501-106	501-109
501-110	501-116	501-120	501-123		

**Unit no.**

**VALEO(MOTOROLA)**

9AL2502K	9AL2505P	9AL2538K	9AL2559G	9AL2572K	9AL2577G
9AL2583K	9AL2584G	9AL2589K	9AL2590K	9AL2591K	9AL2592K
9AL2593K	9AL2600G	9AL2628P	9AL2834K	9AL2873K	9AL2937K
9AL2939K	9AR2501K	9AR2559G	9AR2572K	9AR2592K	9AR2600G
9AR2834K					

**RT-09H**

\*6-35 Amp Diodes



**Replaces**

**LUCAS :**

21229203                    UBB512

**MAGNETI MARELLI :**

940038286

**VALEO :**

2522084                    501102                    592254                    NB787                    592554

**VALEO(DUCELLIER) :**

593027

**VALEO(MOTOROLA) :**

501-014                    501-020                    501-060                    501-095

**Unit no.**

VALEO(MOTOROLA)

9AI2617K	9AR2556K	9AR2566K	9AR2638P	9AR2663K	9AR2672P
9AR2673K	9AR2690P	9AR2691G	9AR2692G	9AR2693P	9AR2694P
9AR2714F	9AR2715F	9AR2755P	9AR2794K	9AR2815K	9AR2856K
9AR2904L	9AR2909P	9AR2930G	9AR2941L0	9AR2941L02	9AR2941L03
9AR2964K	9AR2990P	9AR2995R	9AR2998K	9AR3599G	9AR3620G
9AR3649G	9AR3949K	9AR3949K0	9AR3949K01	9AR3949K02	9AR5001K
9AR5062K	9AR5097P	9AR6093K	9AR6095G		

**RT-10H**

\*6-35 Amp Diodes  
 \*Economy Version: RT-10HA

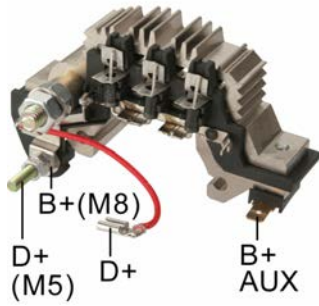

**Replaces**

- AUDI/VW :**  
036903359J
- LUCAS :**  
UBB502
- MAGNETI MARELLI :**  
940038293
- VALEO :**  
A940677A
- VALEO(MOTOROLA) :**  
2523321

**Unit no.**

AUDI/VW					
026903015E					
VALEO					
026903015EV	026903015EX	026903015EY	0269033015E	049903119L	098603031KV
098603171	098903031KX	2541221	2541222	2541395	2541396
2541402	2541438	436191	436192	436193	436296
436368	436369	436370	436399	436400	A13E02
A13E03	A13E04	A13E05	A13E06	A13E07	A13E08
A13E09	A13E10	A13E11	A13E12	A13E13	A13E21
A13E22	A13E43	A13E47	A13E48	A13E49	A13E54
A13E58					
VALEO(MOTOROLA)					
290-300	290-301	290-302	290-303	290-304	290-306
290-307	290-308	290-309	290-310	290-363	290-365
290-367	290-369	290-371	290-373	290-375	2940300
2940301	2940302	2940303	2940304	2940305	2940306
2940307	2940308	2940309	2940310	2940311	2940363
2940365	2940367	2940369	2940371	2940373	2940375

**RT-12H**

\*6-35 Amp Diodes

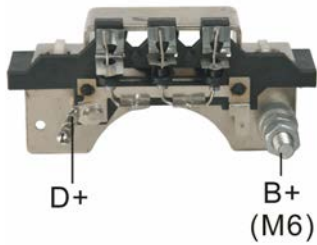

**Replaces**

**MAGNETI MARELLI :**

940038288

**VALEO :**

NB094

**VALEO(MOTOROLA) :**

501-023                      501-026                      501-054

**Unit no.**

VALEO(MOTOROLA)

9AL2633G	9AL2666F	9AL2774G	9AR2633G	9AR2662F	9AR2664F
9AR2729G	9AR2748G	9AR2828G	9AR2829G	9AR2847F	9AR2871G
9AR2875G					

**RT-21H**

\*6-35 Amp Diodes

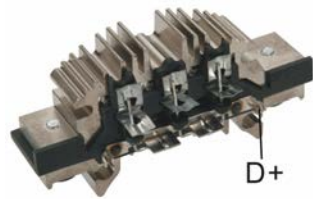

**Replaces**

**LUCAS :**

21229202                      UBB511

**VALEO :**

2522190                      501079                      NB121                      NB785

**VALEO(MOTOROLA) :**

501-034                      501-061                      501-066                      501-078                      501-097                      501-119

**Unit no.**

VALEO					
433430	433437	433453	436318	510146	510147

**RT-23HD**

\*Industrial Alternator Version  
\*6-70 Amp Diodes



**Unit no.**

VALEO(MOTOROLA)

110555

**RT-24HD**

\*Industrial Alternator Version  
\*6-70 Amp Diodes



**Replaces**

VALEO(MOTOROLA) :  
101-205

**Unit no.**

VALEO(MOTOROLA)  
110279            110296            110309

**RP-01**



\*115mm OD  
 \*6-35 Amp Diodes  
 \*With Capacitor

**Replaces**

**DELCO REMY (LUCAS) :**

21225386

**LUCAS :**

UBB232

**VALEO :**

NC145

**VALEO(PARIS RHONE) :**

101743            102527            103543            105380            180593

**Unit no.**

VALEO(PARIS RHONE)

A13N104	A13N110	A13N12	A13N121	A13N13	A13N136
A13N137	A13N139	A13N14	A13N15	A13N150	A13N156
A13N157	A13N158	A13N160	A13N161	A13N162	A13N163
A13N17	A13N187	A13N188	A13N27	A13N29	A13N30
A13N49	A13N50	A13N53	A13N6	A13N64	A13N65
A13N7	A13N85	A13N86	A13N89	A13N97	A14N106
A14N107	A14N12	A14N125	A14N13	A14N131	A14N151
A14N40	A14N50	A14N69	A14N70	A14N85	A14N86

**RP-02**



\*115mm OD  
 \*6-35 Amp Diodes  
 \*With Capacitor, Diode Trio

**Replaces**

**LUCAS :**

UBB235

**VALEO :**

NC136            NC730            592754            593188            593199            593309

**VALEO(PARIS RHONE) :**

102556            103551            181155

**Unit no.**

VALEO(PARIS RHONE)

A13N147M	A13N148M	A13N149M	A13N152M	A13N186	A13N1M
A13N28M	A13N2M	A13N33M	A13N34	A13N35M	A13N36M
A13N51	A13N52	A13N57M	A13N66M	A14N100M	A14N112M
A14N118M	A14N119M	A14N122M	A14N137M	A14N47M	A14N81M



**RP-03**

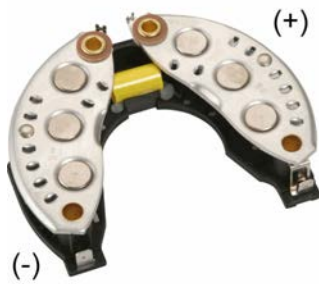

\*115mm OD  
 \*6-35 Amp Doides  
 \*With Capacitor

**Replaces**

**SEV MARCHAL :**

71215303

**VALEO :**

NC133                      NC139                      NC216                      NC936

**VALEO(PARIS RHONE) :**

100157	101217	101759	103539	103576	104292
105135	105135	105629	300082	593194	

**Unit no.**

**SEV MARCHAL**

71635102	71635602	71635902	71636102	71650002	71650402
71650802	71651802	71651902	71652402	71652602	71770102

71770202

**VALEO(PARIS RHONE)**

A13N103	A13N106	A13N113	A13N114	A13N116	A13N120
A13N124	A13N125	A13N126	A13N127	A13N128	A13N146T
A13N159	A13N172	A13N173	A13N18	A13N180	A13N19
A13N20	A13N31	A13N43	A13N62	A13N82	A13N84
A13N87	A13N91	A13N92	A13R258	A14N1	A14N10
A14N101	A14N102	A14N103	A14N113	A14N117	A14N121
A14N130	A14N134	A14N142	A14N150	A14N2	A14N22
A14N35	A14N36	A14N42	A14N51	A14N55	A14N56
A14N59	A14N60	A14N63	A14N64	A14N65	A14N77
A14N83	A14N84	A14N89	A14N9	A14N99	

**RP-04**



- \*115mm OD
- \*6-35 Amp Diodes
- \*With Capacitor, Diode Trio

**Replaces**

**DELCO REMY (LUCAS) :**  
21225400

**SEV MARCHAL :**  
71215003      71215103      71215603      71216203      71216903

**VALEO :**  
592-596      NC138      NC388      NC877

**VALEO(PARIS RHONE) :**  
100931      104971      350011

**Unit no.**

SEV MARCHAL  
71635202      71635502      71635802      71636002      71645002      71650202  
71651202      71651302      71651602      71652202      71655002      71655102  
71655302      71655502      71770002

VALEO(PARIS RHONE)  
A13N109      A13N129      A13N25      A13N39      A13N40      A13N41  
A13N42      A13N46      A13N47      A13N83      A13N9      A13N94  
A14N07      A14N23      A14N78      A14N90      A14N93      A14N97

**RP-04H**



- \*115mm OD
- \*6-50 Amp Diodes
- \*With Capacitor

**Replaces**

**LUCAS :**  
UBB233

**VALEO :**  
592595      NC144      101217      101759      103539      103576  
104292      104971      592779      592877      593180

**VALEO(PARIS RHONE) :**  
180537

**Unit no.**

VALEO(PARIS RHONE)  
A13N123      A13N178      A13N179      A14N18      A14N91      A14N92

**RP-04HR**

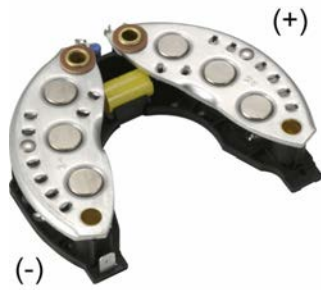

\*115mm OD  
 \*6-50 Amp Diodes  
 \*With Capacitor, Resistor, Diode Trio

**Replaces**

**PEUGEOT :**

5744.61

**VALEO(PARIS RHONE) :**

105554                      2181241

**Unit no.**

VALEO(PARIS RHONE)

A13N130                      A14N80                      A14N82                      A14N88

**RP-04R**



\*115mm OD  
 \*6-35 Amp Diodes  
 \*With Resistor, Diode Trio

**Replaces**

**SEV MARCHAL :**

71215403

**VALEO :**

NC134                      NC217

**VALEO(PARIS RHONE) :**

101773                      101776                      103546

**Unit no.**

SEV MARCHAL

71635702                      71636202                      71636302                      71636402                      71636802                      71636902

71651502                      71652002                      71652102                      71652302                      71652703                      71653102

71653202

VALEO(PARIS RHONE)

A13N32                      A13N38                      A13N40                      A13N41                      A13N42                      A13N83

A13N94                      A13R248                      A13R259                      A13R266                      A13R267                      A13R268

A14N23                      A14N78

**RP-05H**

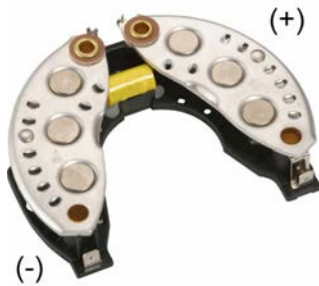

- \*115mm OD
- \*6-50 Amp Diodes
- \*With Capacitor, Diode Trio

**Replaces**

**VALEO(PARIS RHONE) :**  
101713

**Unit no.**

VALEO(PARIS RHONE)  
A14N11          A14N38          A14N71

**RP-06H**



- \*115mm OD
- \*6-50 Amp Diodes
- \*With Capacitor, Diode Trio

**Replaces**

**VALEO :**  
NC137  
**VALEO(PARIS RHONE) :**  
101227          104269

**Unit no.**

VALEO(PARIS RHONE)  
A13N11          A13N133          A13N135          A13N39          A13N44T          A13N45T  
A13R33

**RP-06HR**



- \*115mm OD
- \*6-50 Amp Diodes
- \*With Capacitor, Resistor, Diode Trio

**Replaces**

**VALEO :**  
NC161  
**VALEO(PARIS RHONE) :**  
101342

**Unit no.**

VALEO(PARIS RHONE)  
A13N22T          A13N28T          A13N32T          A13N3T          A13N4T          A13N5T  
A13N61T

**RP-07**

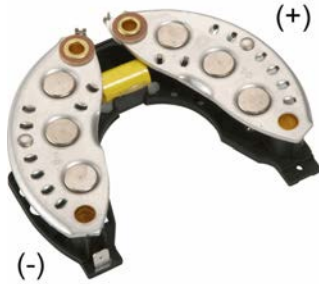

\*115mm OD  
 \*6-35 Amp Diodes  
 \*With Capacitor

**Replaces**

**LUCAS :**

UBB237

**VALEO :**

NC141                      592881

**VALEO(PARIS RHONE) :**

105252                      105690

**Unit no.**

VALEO(PARIS RHONE)

A13N171                      A13N62                      A13N88

**RP-08**

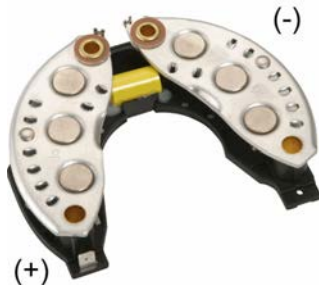

\*115mm OD  
 \*6-35 Amp Diodes  
 \*With Capacitor

**Replaces**

**LUCAS :**

UBB238

**VALEO :**

NC143                      592880                      593190                      593193

**VALEO(PARIS RHONE) :**

104615                      105522                      105523                      106016

**Unit no.**

VALEO(PARIS RHONE)

A13N107                      A13N108                      A13N112                      A13N117                      A13N119                      A13N164

A13N185                      A13N81                      A13N90                      A14N132                      A14N4                      A14N53

A14N54

**RP-09**

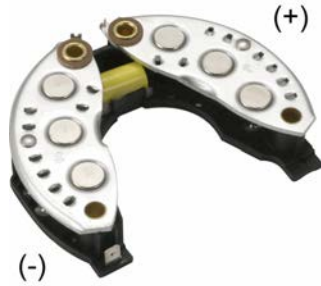

- \*115mm OD
- \*6-35 Amp Diodes
- \*With Capacitor, Diode Trio

**Replaces**

**DELCO REMY (LUCAS) :**

21225379

**VALEO :**

NC976

**VALEO(PARIS RHONE) :**

592747                      592749

**Unit no.**

VALEO(PARIS RHONE)

A13N181                      A13N182                      A13N183                      A13N218                      A13N220

**RP-09A**

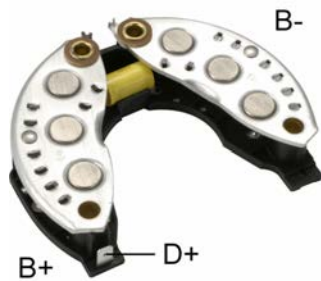

- \*115mm OD
- \*6-35 Amp Diodes
- \*Cut D+ Terminal

**Unit no.**

VALEO(PARIS RHONE)

A13N220

**RP-09R**

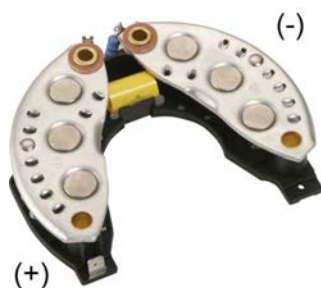

- \*115mm OD
- \*6-35 Amp Diodes
- \*With Capacitor, Resistor, Diode Trio

**Replaces**

**VALEO :**

NC142

**VALEO(PARIS RHONE) :**

105813                      592747

**Unit no.**

VALEO(PARIS RHONE)

A13N167                      A13N181                      A13N182                      A13N95                      A14N16

**RP-10**

\*6-25 Amp Diodes



**Replaces**

**VALEO :**

NC124

**VALEO(PARIS RHONE) :**

92086                      92785                      92919                      92928                      92939

**Unit no.**

VALEO(PARIS RHONE)

A11R1	A11R2	A11R3	A11R4	A12R1	A12R10
A12R11	A12R12	A12R13	A12R14	A12R16	A12R17
A12R19	A12R2	A12R20	A12R21	A12R22	A12R23
A12R24	A12R25	A12R26	A12R27	A12R28	A12R3
A12R30	A12R31	A12R32	A12R33	A12R34	A12R36
A12R37	A12R38	A12R4	A12R42	A12R43	A12R44
A12R45	A12R46	A12R47	A12R48	A12R50	A12R52
A12R53	A12R54	A12R55	A12R56	A12R59	A12R6
A12R8	A12R9				

**RP-11**

\*4-35 Amp Diodes



**Replaces**

**VALEO :**

NC126

**VALEO(PARIS RHONE) :**

78810                      92734                      94450                      96314

**Unit no.**

VALEO(PARIS RHONE)

A11M10	A11M14	A12M1	A12M10	A12M18	A12M2
A12M3	A12M6	A12M7			

**RP-13**



\*107mm OD  
 \*6-50A Avalanche Diodes  
 \*w/o Diode Trio

**Replaces**

**CITROEN :**  
 95644506                      5744C9  
**LUCAS :**  
 UBB254  
**VALEO :**  
 592848

**Unit no.**

VALEO					
2541356	2541360	2541361	2541362	2541455	436259
436261	436336	436340	436362		
VALEO(PARIS RHONE)					
A11VI15	A11VI16	A11VI17	A11VI18	A11VI47	A11VI48
A13VI101	A13VI102	A13VI31	A13VI48	A13VI85	A13VI86
A13VI87					

**RP-14**

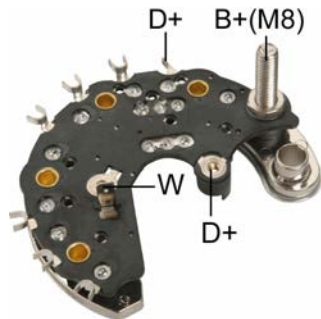

\*107mm OD  
 \*M8 Battery Post  
 \*8-50A Avalanche Diodes

**Replaces**

**LUCAS :**  
 UBB250                      UBB251                      UBB253  
**MAGNETI MARELLI :**  
 940038315                      940038326  
**PEUGEOT :**  
 5744.02  
**VALEO :**  
 NF006

<b>VALEO(PARIS RHONE) :</b>					
2546062	2546076	592844	592917	A546076A	

**Unit no.**

VALEO					
1541683	1541696	1541697	2541348	2541473	2541644
2541656	2541678	2541680	436381	436386	436387
436389					
VALEO(PARIS RHONE)					
A13VI134	A13VI135	A13VI137	A13VI138	A13VI155	A13VI156
A13VI170	A13VI175	A13VI176	A13VI180	A13VI198	A13VI24
A13VI54	A13VI67	A13VI69	A13VI70	A13VI74	A13VI75
A13VI77	A13VI78	A13VI79			



**RP-15**



- \*107mm OD
- \*M8 Battery Post
- \*6-50A Avalanche Diodes

**Replaces**

**VALEO :**  
592845

**Unit no.**

VALEO(PARIS RHONE)

A11VI10	A11VI11	A11VI23	A11VI24	A11VI25	A13VI46
A13VI49	A11VI32	A11VI33	A11VI37	A11VI40	A11VI43
A11VI44	A11VI45				

**RP-16**



- \*107mm OD
- \*M8 Battery Post
- \*6-50A Avalanche Diodes
- \*w/diode trio
- \*Same as RP-24 but without spade W terminal

**Replaces**

**VALEO :**  
592842

**Unit no.**

VALEO(PARIS RHONE)

A13VI126

**RP-17**



- \*107mm OD
- \*M6/M8 Battery Post
- \*8-50A Avalanche Diodes

**Replaces**

**LUCAS :**  
UBB252

**MAGNETI MARELLI :**  
940038316

**VALEO :**  
NF007

**VALEO(PARIS RHONE) :**  
2545941          545940          592846          592847

**Unit no.**

VALEO(PARIS RHONE)					
A11VI104	A11VI105	A11VI106	A11VI107	A11VI11	A11VI13
A11VI131	A11VI29	A11VI30	A11VI31	A11VI59	A11VI61
A13VI14	A13VI153	A13VI16	A13VI17	A13VI20	A13VI21
A13VI22	A13VI23	A13VI25	A13VI28	A13VI30	A13VI32
A13VI34	A13VI35	A13VI45	A13VI47	A13VI52	A13VI55
A13VI57	A13VI62	A13VI64	A13VI65	A13VI66	

**RP-18**



- \*107mm OD
- \*M6/M8 Battery Post
- \*6-50A Avalanche Diodes

**Replaces**

**VALEO(PARIS RHONE) :**  
2545938          592937          545937

**Unit no.**

VALEO(PARIS RHONE)	
A11VI26	A11VI28

**RP-19**



\*115mm OD  
 \*6-35 Amp Diodes  
 \*Same as RP-03 except RP-19 is without Capacitor

**Replaces**

VALEO(PARIS RHONE) :  
 102817

**Unit no.**

VALEO(PARIS RHONE)  
 A13N37          A13N62          A13N69          A13N76          A14N19

**RP-20**



\*6-35 Amp Diodes

**Replaces**

LUCAS :  
 UBB256  
 VALEO(PARIS RHONE) :  
 300903

**Unit no.**

VALEO(PARIS RHONE)  
 A14N104          A14N124          A14N140          A14N67          A14N73          A14N75  
 A14N76          A14N95

**RP-21**



\*8-35 Amp Diodes  
 \*Same as RP-20 but w/8 diodes

**Replaces**

VALEO(PARIS RHONE) :  
 300903

**Unit no.**

VALEO(PARIS RHONE)  
 A14N104          A14N124          A14N140          A14N67          A14N73          A14N75  
 A14N76          A14N95

**RP-22**



- \*107mm OD
- \*M6/M8 Battery Post
- \*6-50A Avalanche Diodes

**Replaces**

VALEO :  
593175

Unit no.

VALEO(PARIS RHONE)  
A11VI54      A11VI76      A11VI77      A11VI79

**RP-23**



- \*107mm OD
- \*M8 Battery Post
- \*8-50A Avalanche Diodes

**Replaces**

VALEO :  
593174

Unit no.

VALEO(PARIS RHONE)  
A13VI118

**RP-24**

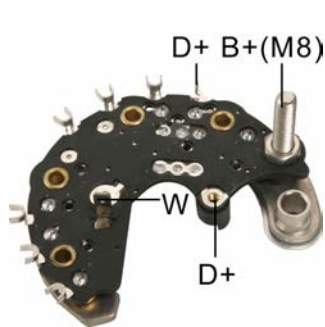

- \*107mm OD
- \*M8 Battery Post
- \*6-50A Avalanche Diodes
- \*w/diode trio
- \*Same as RP-16 but w/ spade W terminal

**Replaces**

VALEO :  
592842

Unit no.

VALEO(PARIS RHONE)  
A13VI126

**RP-27**



- \*107mm OD
- \*M8 Battery Post
- \*6-50A Avalanche Diodes
- \*w/o diode trio

**Replaces**

**VALEO :**  
593320

**Unit no.**

VALEO(PARIS RHONE)

A13VI178      A13VI202      A13VI237      A13VI257

**RP-28**



- \*107mm OD
- \*M8 Battery Post
- \*6-50 Amp Avalanche Diodes

**Replaces**

**VALEO(PARIS RHONE) :**  
593205

**Unit no.**

VALEO(PARIS RHONE)

A14VI19      A14VI20

**RP-35**



- \*107mm OD
- \*M6/M8 Battery Post
- \*8-50A Avalanche Diodes

**Replaces**

**VALEO :**  
593172

**Unit no.**

VALEO(PARIS RHONE)

A13VI167

**RP-36**



- \*107mm OD
- \*M8 Battery Post
- \*6-50A Avalanche Diodes

**Replaces**

VALEO :  
546351

**RP-37**

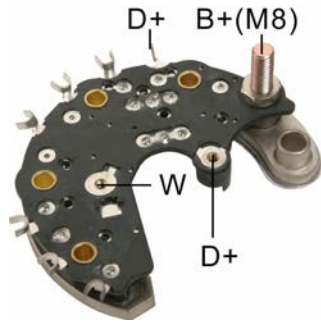

- \*107mm OD
- \*M8 Battery Post
- \*6-50A Avalanche Diodes
- \*w/ diode trio

**Replaces**

VALEO :  
2546041                      593202                      2546040

**Unit no.**

VALEO(PARIS RHONE)

A14VI10                      A14VI11                      A14VI13                      A14VI130                      A14VI131                      A14VI14

**RP-38**

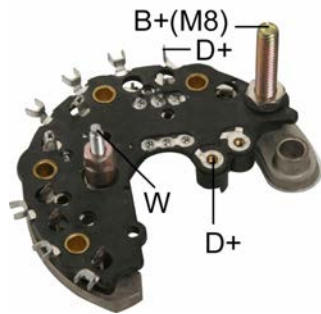

- \*107mm OD
- \*M8 Battery Post
- \*6-50A Avalanche Diodes

**Replaces**

VALEO :  
2548083

**Unit no.**

VALEO  
2542433A

**RP-39H**

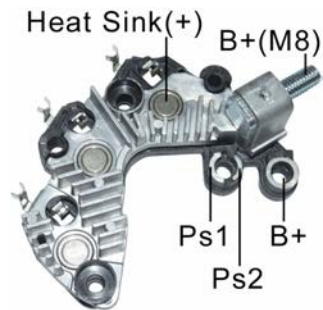

\*6-50A Avalanche Diodes  
 \*w/o Diode Trio  
 \*Used on Citroen C2/C3/Xsara, Peugeot 307

**Replaces**

VALEO :  
 593487

Unit no.

VALEO  
 2542485A      603030256      9642879480

**RP-40H**

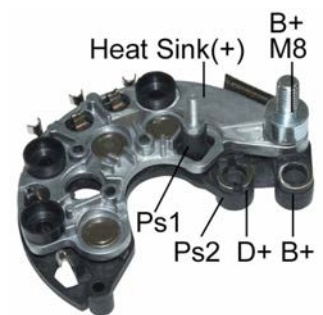

\*M8 Battery Post  
 \*6-50A Avalanche Diodes  
 \*w/ Diode Trio  
 \*Used on Renault Magnum, Premium, Maxter

Unit no.

RENAULT  
 5010306710  
 VALEO  
 2542310      SG12B020

**RP-41**

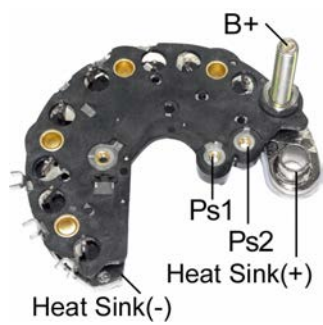

\*8-50A Avalanche Diodes

**Replaces**

VALEO :  
 593667

Unit no.

VALEO  
 SG15L020      SG15L023      SG15L027

**RP-43**

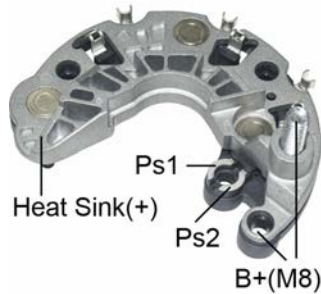

- \*103mm OD
- \*M8 Battery Post
- \*3-50A Avalanche Diodes
- \*Positive Rectifier

**Unit no.**

HYUNDAI					
37300-37405	37300-37400				
VALEO					
2655516	A0002655516	TG11C024	439295	437488	2655010

**Used On**

**HYUNDAI**

Santa 2.7L	2004-
Sonata 2.7L	2003-2004
Tucson 2.7	2004-
Tiburon 2.7L	2003-2004
Tiburon 2.7L	2003-2004

**KIA**

Magentis 2.7	2004-
--------------	-------

**RP-48**

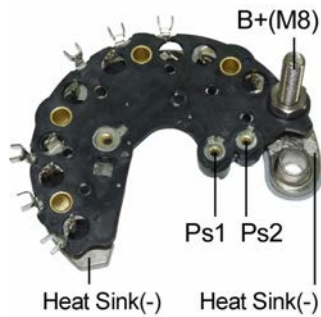

- \*107mm OD
- \*M8 Battery Post
- \*8-50A Avalanche Diodes

**Replaces**

**VALEO :**

593366	593364	593351	593348	593327	593204
592842					

**Unit no.**

VALEO					
A11VI10	A11VI110	A11VI111	A11VI87	A11VI88	A11VI94
A11VI95	A11VI98	A13VI10	A13VI126	A13VI130	A13VI150



**RP-51**

- \*103mm OD
- \*M8 Battery Post
- \*3-50A Avalance Diodes

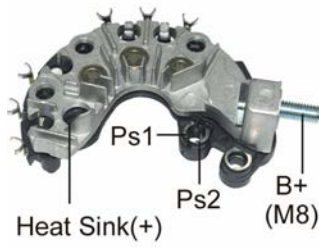

**Replaces**

VALEO :  
593530                      235653

Unit no.

VALEO  
SG10B021              SG10B022              SG10B023              SG10B048

**RT-19H**

- \*6-35 Amp Diodes
- \*Economy Version: RT-19HA

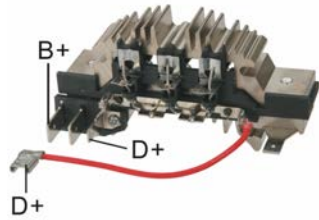

**Replaces**

ISKRA :  
16906614

**RT-20H**

- \*6-35 Amp Diodes
- \*Economy Version: RT-20HA

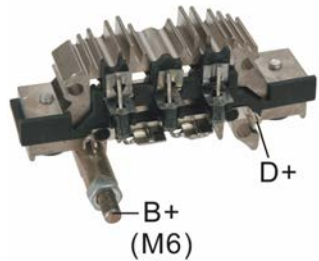

**Replaces**

VALEO(PARIS RHONE) :  
592893

Unit no.

VALEO(PARIS RHONE)  
S13E50